

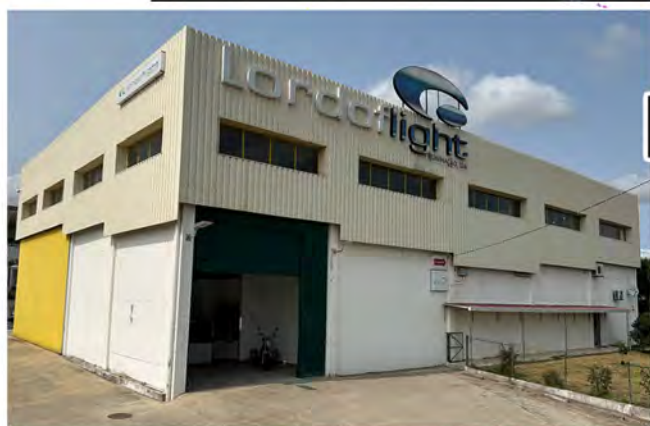

**LORD OF LIGHT**  
ILUMINAÇÃO, LDA



# CATALOGO



## LORD OF LIGHT

A Lord Of Light disponibiliza os mais inovadores produtos de iluminação LED ao preço mais competitivo de mercado.

Orgulhamo-nos de ter um serviço de excelência baseado na relação de confiança duradoura que temos com os nossos clientes!



Fundada em Setembro de 2009, a **Lord of Light** é uma empresa PME líder de mercado que se dedica a importação e distribuição de iluminação LED.

Através da nossa marca registada **LOFL** orgulhamo-nos de estarmos representados pelo principais distribuidores de material eléctrico e de iluminação LED de referência no mercado Nacional.

A Lord of Light dispõe de equipamentos que permitem verificar e testar todos os nossos produtos, de forma a fornecer aos nossos clientes informações precisas acerca dos produtos comercializados.



Desde a sua fundação que o nosso principal objetivo consiste na disponibilização de produtos com a melhor qualidade/preço de modo a garantir a máxima satisfação dos nossos clientes. No sentido de estarmos sempre na vanguarda da inovação estamos presentes nas principais feiras internacionais que ocorrem nos diversos continentes. Estamos sempre disponíveis para esclarecer quaisquer tipos de questões relacionadas com iluminação Led. Temos os melhores recursos disponíveis no mercado para o aconselhar no seu projeto, não hesite em contactar-nos!



# INDICE

## PAGINA • DESCRICAO

4	Lampadas Spot HP - MR11/ MR16/GU10/ E14 e E27	
7	Lampadas Spot SMD - MR11/ MR16 e GU10	
10	Aros GU10 -MR16	
13	Lampadas G4	
15	Lampadas G9	
17	Lampadas - C37-G45-A60-G60-R63-R80-R50-A125- Filamento - SOFT LED	
26	Corns 3U / 4U / T100	Iluminação de Jardim e Solar 67.
28	DownLights	Steplights 77.
35	Lâmpadas AR 111	Paineis de Encastrar 82.
37	PAR 20-30-38	Paineis de Superficie 88.
39	Lâmpadas R7S	Paineis Customizados - CCT e Ajustáveis 91.
42	PLC G24/E27	Hay Bays 94.
44	Lâmpadas T5 - T8 e Réguas para Armários	Lâmpdas Industriais - Corns E40 e E27 98.
49	Armaduras de Emergência	Fita de Led 12VDC 100.
51	Armaduras Estanque	Fita de Led 24VDC 107.
53	Lâmpadas e Acessórios de Piscina	Fita de Led 230VAC 115.
57	Projetores de Exterior	Fio Electroluminiscente (EI Wire) - Neon Flex 119.
63	Iluminação de Estadio	Controladores RGB - CCT - DIM - DMX 123.
65	Iluminação de Rua	Sensores 134.
		Dimmers 141.
		Kinetic Switch 145.
		Amplificadores 148.
	Transformadores 153.	
	MEANWELL 156.	
	Track Lights 158.	
	Conectores- Conversores 163.	
	Perfil 167.	
	Linear 174.	
	Candeeiros 182.	
	Carregadores Carros Eletricos 192.	
	Condicoes de Venda 194.	



# 1 SPOT HP



1-KG5COB-6



Referencia	Potencia	Lumens	Temp. Cor	Voltagem	Base	Dimensão	Led COB
1-KG5COB-6			6000K				
1-KG5COB-4	5W	500	4000K	200 - 250VAC	GU10	Ø50x56mm	1
1-KG5COB-3			3000K				

## Spot MR 11 HP



### Especificações técnicas:

Material: Ceramic  
Equivalencia: 40W Halogéneo  
Cobertura: Transparente

60°



IP

40

FP

0,90

CRI

&gt;80

Referencia	Potencia	Lumens	Temp. Cor	Voltagem	Base	Dimensão	Led	Preço
040	4W	400	6000K	12VAC/DC	MR11	Ø35x40mm	4	3,55 €
041		350	3000K					

## Spot GU10 4W



002/N

002/NWWW

### Especificações técnicas:

Material: Liga Alumínio  
Equivalencia: 50W Halogéneo  
Cobertura: Transparente



60°



IP

40

FP

0,90

CRI

&gt;80

Referencia	Potencia	Lumens	Temp. Cor	Voltagem	Base	Dimensão	Led	Preço
187/N	4W	400	6000K	12VAC/DC	MR16	Ø50x58mm	4	4,06 €
002/N		300	6000K	200 - 250VAC	GU10	Ø50x60mm		
002/NWWW		240	3000K	200 - 250VAC	GU10	Ø50x60mm		
002		300	6000K	200 - 250VAC	GU10	Ø50x57mm		
002/MWW		240	3000K	200 - 250VAC	GU10	Ø50x57mm		

## Spot GU10 5W



### Especificações técnicas:

Material: Alumínio  
Equivalencia: 50W Halogéneo  
Cobertura: Transparente



60°



IP

40

FP

0,90

CRI

&gt;80

Referencia	Potencia	Lumens	Temp. Cor	Voltagem	Base	Dimensão	Led	Preço
1-KG5X1-6	5W	450	6000K	175 - 265VAC	GU10	Ø50x58mm	5	1,50 €
1-KG5X1-3		390	3000K	175 - 265VAC	GU10	Ø50x58mm		

## Spot GU10 6W



### Especificações técnicas:

Material: Alumínio  
Equivalencia: 50W Halogéneo  
Cobertura: Transparente



60°



IP

40

FP

0,90

CRI

&gt;80

Referencia	Potencia	Lumens	Temp. Cor	Voltagem	Base	Dimensão	Led	Preço
009/N	6W	550	6000K	175 - 265VAC	GU10	Ø50x60mm	3	4,57 €
010/N		500	3000K	175 - 265VAC	GU10	Ø50x60mm		

## Spot GU10 5W COB



1-KG5COB-6

### Especificações técnicas:

Material: Alumínio  
Equivalencia: 50W Halogéneo  
Cobertura: Transparente



60°



IP

40

FP

0,90

CRI

&gt;80

Referencia	Potencia	Lumens	Temp. Cor	Voltagem	Base	Dimensão	Led COB	Preço
1-KG5COB-6	5W	500	6000K	200 - 250VAC	GU10	Ø50x56mm	1	3,30 €
1-KG5COB-4			4000K					
1-KG5COB-3			3000K					

## Spot Dimmable 5W COB



### Especificações técnicas:

Material: Alumínio  
Equivalência: 50W Halogéneo  
Cobertura: Transparente

**BRIDGELUX**  
The Magic of Light™



Referencia	Potencia	Lumens	Temp. Cor	Voltagem	Base	Dimensão	Led COB	Preço
025/MRC	5W	500	6000K	12VAC/DC	MR16	Ø50x51mm	1	7,61 €
026/MRC		450	3000K	12VAC/DC	MR16	Ø50x51mm		
025/NCOB		500	6000K	85 - 265VAC	GU10	Ø50x61,5mm		
026/NCOB		450	3000K	85 - 265VAC	GU10	Ø50x61,5mm		
025/7MRC	7W	700	6000K	12VAC/DC	MR16	Ø50x78mm	1	8,89 €
026/7MRC		650	3000K	12VAC/DC	MR16	Ø50x78mm		

## Spot Cob Dimmable 7W



### Especificações técnicas:

Material: Alumínio  
Equivalência: 75W Halogéneo  
Cobertura: Transparente

**BRIDGELUX**  
The Magic of Light™



Referencia	Potencia	Lumens	Temp. Cor	Voltagem	Base	Dimensão	Led COB	Preço
025/7COBN	7W	700	6000K	85 - 265VAC	GU10	Ø50x60mm	1	9,33 €

## Spot Cob Dimmable 7W



### Especificações técnicas:

Material: Alumínio  
Equivalência: 75W Halogéneo  
Cobertura: Transparente

**BRIDGELUX**  
The Magic of Light™



Referencia	Potencia	Lumens	Temp. Cor	Voltagem	Base	Dimensão	Led COB	Preço
026/7COBN	6,5W	650	3000K	85 - 265VAC	GU10	Ø49,5x52,5mm	1	4,67 €
026/7COBN84		700	4000K					

## Spot RGB 3W / 5W



### Especificações técnicas:

Material: Alumínio  
Cobertura: Transparente

Comando Remoto Incluído

**EPISTAR**



Referencia	Potencia	Lumens	Temp. Cor	Voltagem	Base	Dimensão	Led	Preço		
005	3W		R	200 - 250VAC	E14	Ø50x60/78mm	1	5,67 €		
006			G							
033			B							
033/5	5W		R	G	B	200 - 250VAC	GU10	Ø50x70mm	1	9,21 €

## Spot RGB+W+WW 5W

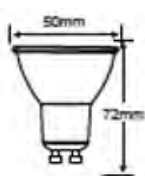

**tuya.com**  
Smart life, smart living



Referencia	Potencia	Lumens	Temp. Cor	Voltagem	Base	Dimensão	Led	Preço
033/RGB-WT	5W	400	R G B + CCT	85 - 265VAC	GU10	Ø50x57mm		8,88 €

# 2 SPOT SMD

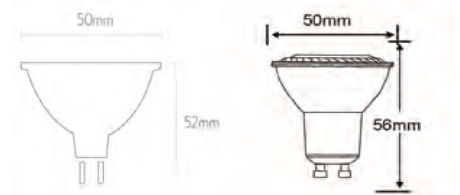

Referencia	Potencia	Lumens	Temp. Cor	Voltagem	Base	Dimensão	Led SMD
029/7.5MR	7,5W	690	6000K	12VAC/DC	MR16	Ø50x52mm	2835-80
030/7.5MR		680	3000K	12VAC/DC	MR16	Ø50x52mm	
029/7.5		690	6000K	85 - 265VAC	GU10	Ø50x56mm	
030/7.5 84		690	4000K	85 - 265VAC	GU10	Ø50x56mm	
030/7.5		680	3000K	85 - 265VAC	GU10	Ø50x56mm	

## Spot SMD 4W

Especificações técnicas:

Material:  
Equivalencia  
Cobertura

Alumínio  
50W Halógeno  
Transparente



Referencia	Potencia	Lumens	Temp. Cor	Voltagem	Base	Dimensão	Led SMD	Preço
034-C/MR		400	6000K	12VAC/DC	MR16	Ø50x57mm		
034-C+	4W	400	6000K	200 - 250VAC	GU10	Ø50x64mm	2835-80	4,18 €
035-C+		340	3000K	200 - 250VAC	GU10	Ø50x64mm		
034-C+D	 4W	400	6000K	200 - 250VAC	GU10	Ø50x64mm	2835-80	5,28 €

## Spot SMD 4W

Especificações técnicas:

Material:  
Equivalencia  
Cobertura

Cerâmica  
40W Halógeno  
Transparente



Referencia	Potencia	Lumens	Temp. Cor	Voltagem	Base	Dimensão	Led SMD	Preço
034-C30+	4W	380	6000K	200 - 250VAC	GU10	Ø50x57mm	3014-30	3,52 €

## Spot SMD 4,5W

Especificações técnicas:

Material:  
Equivalencia  
Cobertura

Alumínio  
50W Halógeno  
Transparente



Referencia	Potencia	Lumens	Temp. Cor	Voltagem	Base	Dimensão	Led SMD	Preço
029-C+	3W	350	6000K	200 - 250VAC	GU10	Ø50x57mm	2835-18	1,20 €
030-C+		320	3000K	200 - 250VAC	GU10	Ø50x57mm		
029-C24+	4,5W	450	6000K	200 - 250VAC	GU10	Ø50x57mm	2835-24	2,86 €
030-C24+		400	3000K	200 - 250VAC	GU10	Ø50x57mm		



## Spot SMD 4.5W



### Especificações técnicas:

Material: Alumínio/plástico  
 Equivalencia: 40W Halogéneo  
 Cobertura: Opalino



Referencia	Potencia	Lumens	Temp. Cor	Voltagem	Base	Dimensão	Led SMD	Preço
GU06/12SMD		400	6000K	220 - 250VAC	GU10	Ø50x60mm		
GU04/12SMD	4,5W	380	4000K	220 - 250VAC	GU10	Ø50x60mm	2835-12	1,67 €
GU03/12SMD		360	3000K	220 - 250VAC	GU10	Ø50x60mm		

## Spot SMD 7,5W



### Especificações técnicas:

Material: Alumínio  
 Equivalencia: 50W Halogéneo  
 Cobertura: Opalino



Referencia	Potencia	Lumens	Temp. Cor	Voltagem	Base	Dimensão	Led SMD	Preço
029/7.5MR		690	6000K	12VAC/DC	MR16	Ø50x51mm		
030/7.5MR		680	3000K	12VAC/DC	MR16	Ø50x51mm		
029/7.5	7,5W	690	6000K	85 - 265VAC	GU10	Ø50x51mm	2835-80	4,19 €
030/7.5 84		690	4000K	85 - 265VAC	GU10	Ø50x51mm		
030/7.5		680	3000K	85 - 265VAC	GU10	Ø50x51mm		



# 3 AROS GU10-MR16

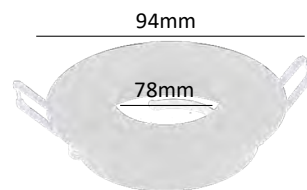
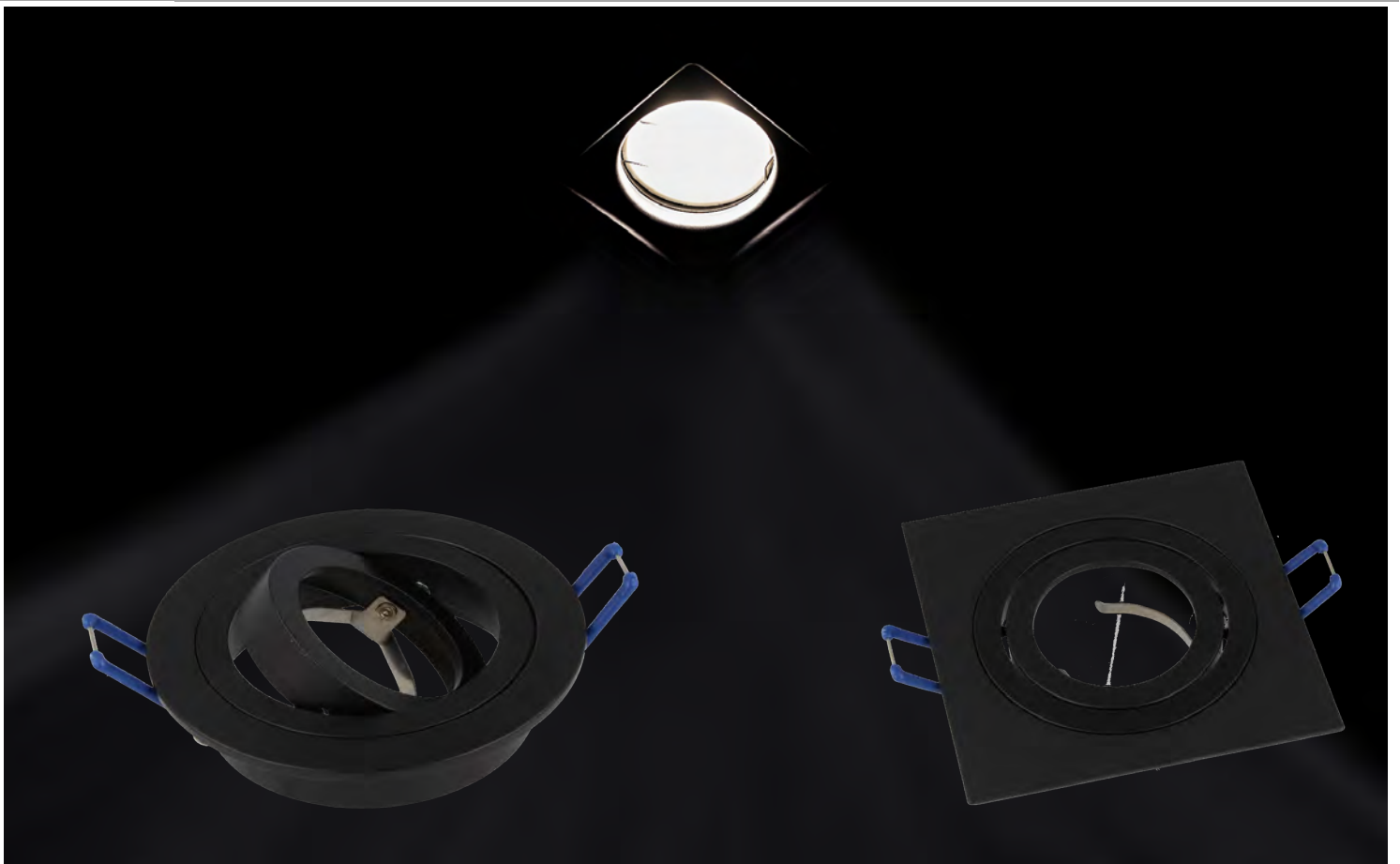

Referencia	Corte	Dimensão	Base
648/OP	78mm	94mm	Redondo
649/OP	78mm	94X94mm	Quadrado

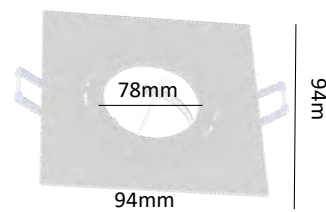

## AROS GU10/MR16



Especificações técnicas:  
 Material: Alumínio  
 Funcionalidade: Orientável

Referencia	Corte	Dimensão	Base	Preço
648/OP	78mm	94mm	Redondo	4,01 €
649/OP	78mm	94X94mm	Quadrado	

## AROS GU10/MR16



Especificações técnicas:  
 Material: Alumínio  
 Funcionalidade: Orientável

Referencia	Corte	Dimensão	Cor	Preço
800/OB	72mm	82x82mm	Branco	2,03 €

## AROS GU10/MR16



Especificações técnicas:  
 Material: Alumínio  
 Funcionalidade: Orientável

Referencia	Corte	Dimensão	Cor	Preço
6101/OB	65mm	88mm	Branco	1,32 €
6101/ON			Nickel	

## AROS GU10/MR16



Especificações técnicas:  
Material: Alumínio  
Funcionalidade: Orientável

Referencia	Corte	Dimensão	Cor	Preço
6401/OB	63mm	87x87mm	Branco	1,32 €
6401/ON			Nickel	

## AROS GU10/MR16

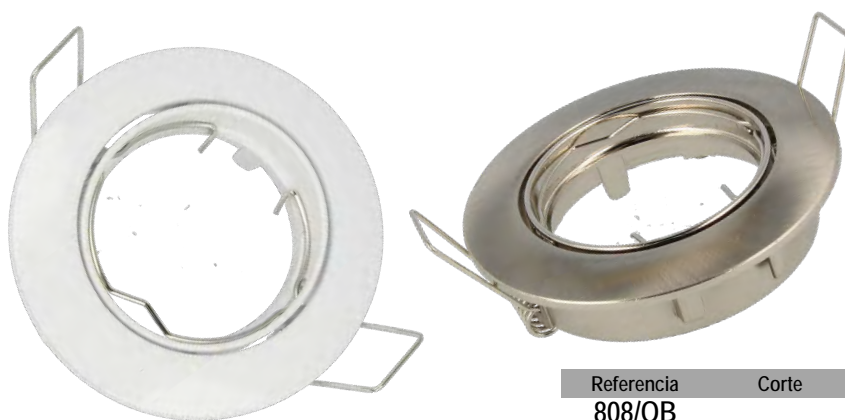

Especificações técnicas:  
Material: Alumínio  
Funcionalidade: Orientável

Referencia	Corte	Dimensão	Cor	Preço
808/OB	74mm	84mm	Branco	2,16 €
808/ON			Nickel	

## AROS GU10/MR16



Especificações técnicas:  
Material: Alumínio  
Funcionalidade: Fixo  
IP: 65

Referencia	Corte	Dimensão	Cor	Preço
650/FB	74mm	84mm	Branco	3,42 €
650/FN			Nickel	

# 4 G4



Referencia	Potencia	Lumens	Temp. Cor	Voltagem	Base	Dimensão	Led SMD
077/3P		260	6000K				
078/3P	2W	240	3000K	12VAC/DC	G4	Ø16x35mm	2835-33

## G4 SMD 1,5W

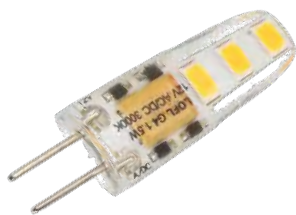
Especificações técnicas:

Material: Plástico  
 Equivalencia: 30W Halógeno  
 Cobertura: Transparente



Referencia	Potencia	Lumens	Temp. Cor	Voltagem	Base	Dimensão	Led SMD	Preço
078/1.5-3	1,5W	140	3000K	12VAC/DC	G4	Ø10X38mm	2835-6	2,46 €

## G4 SMD 2W

Especificações técnicas:

Material: Plástico  
 Equivalencia: 30W Halógeno  
 Cobertura: Sem



Referencia	Potencia	Lumens	Temp. Cor	Voltagem	Base	Dimensão	Led SMD	Preço
077/2,5	2,5W	260	6000K	12VAC/DC	G4	Ø15x42mm	3014-20	2,00 €
078/2,5		240	3000K					

## G4 SMD 2W

Especificações técnicas:

Material: Plástico  
 Equivalencia: 30W Halógeno  
 Cobertura: Transparente



Referencia	Potencia	Lumens	Temp. Cor	Voltagem	Base	Dimensão	Led SMD	Preço
077/3P	2W	260	6000K	12VAC/DC	G4	Ø16x35mm	2835-33	2,40 €
078/3P		240	3000K					

## G4 SMD 2W

Especificações técnicas:

Material: Plástico  
 Equivalencia: 30W Halógeno  
 Cobertura: Transparente



Referencia	Potencia	Lumens	Temp. Cor	Voltagem	Base	Dimensão	Led SMD	Preço
077/3	2W	140	6000K	12VAC/DC	G4	Ø11x23mm		2,00 €
078/3	2W	140	3000K					

## G4 SMD 2,5W

Especificações técnicas:

Material: Plástico  
 Equivalencia: 30W Halógeno  
 Cobertura: Sem



Referencia	Potencia	Lumens	Temp. Cor	Voltagem	Base	Dimensão	Led SMD	Preço
148+	2W	190	6000K	12VAC/DC	G4	Ø25x35mm	5050-9	6,77 €
149+	2W	210	3000K			Ø30x35mm	5050-12	

5 G9

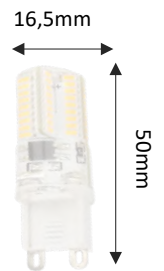

Referencia	Potencia	Lumens	Temp. Cor	Voltagem	Base	Dimensão	Led SMD
088/3D-3	3,3W	300	3000K	200 - 250VAC	G9	Ø16,5X50mm	2835-51

## G9 SMD 2,4W

Especificações técnicas:

Material: Plástico/Silicone  
 Equivalencia: 20W Halogéneo  
 Cobertura: Opalino



Referencia	Potencia	Lumens	Temp. Cor	Voltagem	Base	Dimensão	Led SMD	Preço
087/SE	2.4W	220	6000K	200 - 250VAC	G9	Ø15X46mm	2835-16	2,43 €
088/SE		200	3000K					

## G9 SMD 3W

Especificações técnicas:

Material: Plástico/Silicone  
 Equivalencia: 20W Halogéneo  
 Cobertura: Transparente



Referencia	Potencia	Lumens	Temp. Cor	Voltagem	Base	Dimensão	Preço	Preço
087/S4	3W	270	4000K	200 - 250VAC	G9	Ø15X46mm	3014-64	3,40 €
088/S		250	3000K					

## G9 SMD 3,3W

Especificações técnicas:

Material: Plástico  
 Equivalencia: 30W / 60W Halogéneo  
 Cobertura: Transparente



Referencia	Potencia	Lumens	Temp. Cor	Voltagem	Base	Dimensão	Preço	Preço
087/3P	3,3W	300	6000K	200 - 250VAC	G9	Ø16,5X50mm	2835-51	2,71 €
088/3P		300	3000K					
087/860	4,5W	400	6000K	200 - 250VAC	G9	Ø16X60mm	2835-75	3,14 €
087/840		370	4000K					

## G9 COB 4,5W

Especificações técnicas:

Material: Plástico  
 Equivalencia: 30W Halogéneo  
 Cobertura: Sem



Referencia	Potencia	Lumens	Temp. Cor	Voltagem	Base	Dimensão	LED COB	Preço
087/COBN	4,5W	410	6000K	200 - 250VAC	G9	14X50mm	2	3,30 €
088/COBN		390	3000K					

## G9 COB 2W

Especificações técnicas:

Material: Plástico  
 Equivalencia: 30W Halogéneo  
 Cobertura: Transparente



Referencia	Potencia	Lumens	Temp. Cor	Voltagem	Base	Dimensão	Led SMD	Preço
087/2	2W	180	6000K	200 - 250VAC	G9	Ø17X45,75mm	1	2,00 €
088/2		160	3000K					

## G9 SMD 3W Dimmable

Especificações técnicas:

Material: Plástico/Silicone  
 Equivalencia: 30W/40W Halogéneo  
 Cobertura: Transparente



Referencia	Potencia	Lumens	Temp. Cor	Voltagem	Base	Dimensão	Led SMD	Preço
088/3D-3	3,3W	300	3000K	200 - 250VAC	G9	Ø16,5X50mm	2835-51	3,22 €



# 6 Bulb



Referencia	Potencia	Lumens	Temp. Cor	Voltagem	Base	Dimensão	Led Filament
045/95F8HSD	8W	800	3000K	200 - 265VAC	E27	Ø95x135mm	8
045/125F8HSD						Ø125x175mm	

## Bulb C37 4W

Especificações técnicas:

Material: Plástico  
 Equivalencia: 40W Halogéneo  
 Cobertura: Opalina



Referencia	Potencia	Lumens	Temp. Cor	Voltagem	Base	Dimensão	Led SMD	Preço
C37E14/4W-6	4W	400	6000K	200 - 250VAC	E14	Ø37x97mm	2835-8	1,36 €
C37E14/4W-3		380	3000K		E14			
C37E27/4W-6		400	6000K	201 - 250VAC	E27			
C37E27/4W-3		380	3000K		E27			
C37E14/6W-6	6W	640	6000K	200 - 250VAC	E14	Ø37x97mm	2835-12	1,69 €
C37E14/6W-3		610	3000K		E14			
C37E27/6W-6		640	6000K	200 - 250VAC	E27			
C37E27/6W-3		610	3000K		E27			

## Bulb G45 4W

Especificações técnicas:

Material: Plástico  
 Equivalencia: 40W Halogéneo  
 Cobertura: Opalina



Referencia	Potencia	Lumens	Temp. Cor	Voltagem	Base	Dimensão	Led SMD	Preço
G45E14/4W-6	4W	432	6000K	200 - 250VAC	E14	Ø45x102mm	2835-8	1,36 €
G45E14/4W-3		415	3000K		E14			
G45E27/4W-6		432	6000K	201 - 250VAC	E27			
G45E27/4W-3		415	3000K		E27			
G45E14/6W-6	6W	640	6000K	200 - 250VAC	E14	Ø45x102mm	2835-12	1,69 €
G45E14/6W-3		610	3000K		E14			
G45E27/6W-6		640	6000K	200 - 250VAC	E27			
G45E27/6W-3		610	3000K		E27			

## Bulb A60

Especificações técnicas:

Material: Plástico  
 Cobertura: Opalina



Referencia	Potencia	Lumens	Temp. Cor	Voltagem	Base	Dimensão	Led SMD	Preço
044/ECO-6	10W	1100	6000K	200 - 250VAC	E27	Ø60x126mm	3020-10	1,77 €
044/ECO-4		1050	4000K					
045/ECO-3		1000	3000K					
044/ECO15-6	15W	1500	6000K	200 - 250VAC	E27	Ø60x120mm	3020-15	2,87 €
044/ECO15-4		1450	4000K					
045/ECO15-3		1400	3000K					
044/24	10W	1000	6000K	24AC/DC	E27	Ø60x120mm	3020-10	3,30 €
045/24		900	3000K					

## Bulb G60

Especificações técnicas:

Material: Plástico  
Cobertura: Opalina



Referencia	Potencia	Lumens	Temp. Cor	Voltagem	Base	Dimensão	Led SMD	Preço
103/WECO	7W	560	6000K	200 - 250VAC	E27	Ø60x90mm	2835-28	2,23 €
103/WWECO		470	3000K					

## Bulb A125

Especificações técnicas:

Material: Alumínio/Plástico  
Cobertura: Opalina



Referencia	Potencia	Lumens	Temp. Cor	Voltagem	Base	Dimensão	Led SMD	Preço
044/125	12W	1055	6000K	175 - 265VAC	E27	Ø125x60mm	2835-24	6,04 €
045/125		900	3000K					

## Bulb A125

Especificações técnicas:

Material: Vidro  
Cobertura: Opalina



Referencia	Potencia	Lumens	Temp. Cor	Voltagem	Base	Dimensão	Led Filament	Preço
045/125F8M	12W	1055	3000K	175 - 265VAC	E27	Ø125x60mm	8	6,24 €

## Bulb Chama 4W Decorativa Gold

Especificações técnicas:

Material: Cerâmico/Vidro  
Cobertura: Transparente/Gold



Referencia	Potencia	Lumens	Temp. Cor	Voltagem	Base	Dimensão	Led SMD	Preço
144/W	6W	470	6000K	200 - 250VAC	E14	Ø37x102mm	2835-12	2,79 €
144/WW		440	3000K					

## Bulb A60 MOSQUITO KILLER

Especificações técnicas:

Material:  
Cobertura

Plástico  
Opalina

## EPISTAR



Referencia	Potencia	Lumens	Temp. Cor	Voltagem	Base	Dimensão	Led	Preço
044/MOS	8W	560	1800K (AMARELO)	110-240V	E27	115X60MM	1	5,71 €

## Bulb R63

Especificações técnicas:

Material:  
Equivalencia  
Cobertura

Cerâmico/Vidro  
30W Halógeno  
Opalina



Referencia	Potencia	Lumens	Temp. Cor	Voltagem	Base	Dimensão	Led SMD	Preço
043	7W	550	3000K	200 - 250VAC	E27	Ø63x107mm	5630-14	2,92 €
042/840		650	4000K					

## Bulb R80

Especificações técnicas:

Material:  
Equivalencia  
Cobertura

Alumínio/Plástico  
60W Halógeno  
Opalina



Referencia	Potencia	Lumens	Temp. Cor	Voltagem	Base	Dimensão	Led SMD	Preço
042/R80	10W	900	6000K	200 - 250VAC	E27	Ø80x120mm	2835-20	3,78 €
043/R80		800	3000K					

## Bulb R50

Especificações técnicas:

Material:  
Equivalencia  
Cobertura

Alumínio/Plástico  
30W Halógeno  
Opalina



Referencia	Potencia	Lumens	Temp. Cor	Voltagem	Base	Dimensão	Led SMD	Preço
050/ECO-3		390	3000K	200 - 250VAC	E14	Ø50x85mm	2835-24	2,03 €

## Bulb C37 Filamento 2W

Especificações técnicas:

Material:	Vidro
Equivalencia	30W Halogéneo
Cobertura	Transparente
Tipo de Led:	Filamento



Referencia	Potencia	Lumens	Temp. Cor	Voltagem	Base	Dimensão	Led Filament	Preço
107/FIL	2W	230	3000K	200 - 265VAC	E14	Ø37x100mm	2	1,56 €

## Bulb C37 Filamento 4W Dimmable

107/4FGD



107/4FDGD



107/4FDGD27

Especificações técnicas:

Material:	Vidro
Equivalencia	30W Halogéneo
Cobertura	Dourada



Referencia	Potencia	Lumens	Temp. Cor	Voltagem	Base	Dimensão	Led Filament	Preço
107/4FDGD	4W	330	3000K	200 - 265VAC	E14	Ø37x120mm	4	2,89 €
107/4FGD	4W	330	3000K	200 - 265VAC	E14	Ø37x120mm	4	
107/4FDGD27	4W	330	3000K	200 - 265VAC	E27	Ø37x100mm	4	

## Bulb G45 Filamento 4W Dimmable

Especificações técnicas:

Material:	Vidro
Equivalencia	30W Halogéneo
Cobertura	Dourada



Referencia	Potencia	Lumens	Temp. Cor	Voltagem	Base	Dimensão	Led Filament	Preço
142/4FGD	4W	330	3000K	200 - 265VAC	E14	Ø45x72mm	4	2,33 €
143/4FGD		330	3000K		E27			

## Bulb A60 Filamento 6W/8W

Especificações técnicas:

Material:	Vidro
Equivalencia. 6W/8W	30W/40W Halogéneo
Cobertura	Transparente



Referencia	Potencia	Lumens	Temp. Cor	Voltagem	Base	Dimensão	Led Filament	Preço
045/6FIL	6W	650	3000K	200 - 265VAC	E27	Ø60x110mm	6	3,13 €
045/8FIL	8W	850	3000K					3,76 €

## Bulb A60 Filamento 8W Dimmable

Especificações técnicas:

Material: Vidro  
 Equivalencia. 6W/8W 40W Halogéneo  
 Cobertura Dourada



Referencia	Potencia	Lumens	Temp. Cor	Voltagem	Base	Dimensão	Led Filament	Preço
045/8FGD	8W	850	3000K	200 - 265VAC	E27	Ø60x110mm	6	4,49 €

## Bulb ST 64 Filamento 8W Dimmable

Especificações técnicas:

Material: Vidro  
 Equivalencia 40W Halogéneo  
 Cobertura Dourada  
 Filamentos 8



Referencia	Potencia	Lumens	Temp. Cor	Voltagem	Base	Dimensão	Dimável	Preço
046/ST8GD	8W	800	3000K	200 - 265VAC	E27	Ø64x145mm	Sim	6,15 €

## Bulb G95 / G125 Filamento 6W/8W

Especificações técnicas:

Material: Vidro  
 Equivalencia 8W/6W 60W/40W Halogéneo  
 Cobertura Transparente



Referencia	Potencia	Lumens	Temp. Cor	Voltagem	Base	Dimensão	Led Filament	Preço
045/95F8	8W	800	3000K	200 - 265VAC	E27	Ø125x172mm	6	4,49 €
045/125F8	8W	800	3000K					5,62 €
045/125F6	6W	650	3000K					3,68 €

## Bulb G95 / G125 Filamento 8W Dimmable

Especificações técnicas:

Material: Vidro  
 Equivalencia 8W/6W 40W Halogéneo  
 Cobertura Dourada



Referencia	Potencia	Lumens	Temp. Cor	Voltagem	Base	Dimensão	Led Filament	Preço
045/95F8GD	8W	800	3000K	200 - 265VAC	E27	Ø95x135mm	8	5,00 €
045/125F8GD						Ø125x175mm		5,81 €

## Bulb G95 / G125 Filamento 8W Dimmable

Especificações técnicas:

Material: Vidro  
 Equivalencia 8W/6W 40W Halogéneo  
 Cobertura Metade Prateada



360°

IP 40

FP 0,90

CRI &gt;80

Referencia	Potencia	Lumens	Temp. Cor	Voltagem	Base	Dimensão	Led Filament	Preço
045/95F8HSD	8W	800	3000K	200 - 265VAC	E27	Ø95x135mm	8	3,70 €
045/125F8HSD						Ø125x175mm		4,95 €

## Bulb R50 Filamento E14

Especificações técnicas:

Material: Vidro  
 Equivalencia 20W Halogéneo  
 Cobertura Transparente

160°

IP 40

FP 0,90

CRI &gt;80

Referencia	Potencia	Lumens	Temp. Cor	Voltagem	Base	Dimensão	Led Filament	Preço
R50/14F2	2W	220	3000K	220 - 240VAC	E14	Ø50x84mm	2	2,45 €

## Bulb R63 Filamento E27

Especificações técnicas:

Material: Vidro  
 Equivalencia 40W Halogéneo  
 Cobertura Transparente

160°

IP 40

FP 0,90

CRI &gt;80

Referencia	Potencia	Lumens	Temp. Cor	Voltagem	Base	Dimensão	Led Filament	Preço
R63/27F6	6W	500	3000K	220 - 240VAC	E27	Ø63x94mm	6	3,61 €

## Bulb R80 Filamento E27

Especificações técnicas:

Material: Vidro  
 Equivalencia 60W Halogéneo  
 Cobertura Transparente

160°

IP 40

FP 0,90

CRI &gt;80

Referencia	Potencia	Lumens	Temp. Cor	Voltagem	Base	Dimensão	Led Filament	Preço
R80/27F8	8W	600	3000K	220 - 240VAC	E27	Ø80x109mm	8	4,34 €

## Bulb SOFT LED A60

Especificações técnicas:

Material: Vidro  
Cobertura: Dourada



Referencia	Potencia	Temp. Cor	Base	Dimensão	Preço
045/SOFT4WG	4W	2300K	E27	Ø60x110mm	5,62 €

## Bulb SOFT LED G125

Especificações técnicas:

Material: Vidro  
Cobertura: Dourada



Referencia	Potencia	Temp. Cor	Base	Dimensão	Preço
G125/SOFT6WG	6W	2300K	E27	Ø125x172mm	6,52 €

## Bulb SOFT LED ST64

Especificações técnicas:

Material: Vidro  
Cobertura: Dourada



Referencia	Potencia	Temp. Cor	Base	Dimensão	Preço
ST64/SOFT6WG	6W	2300K	E27	Ø64x145mm	5,62 €





## Bulb Decorativa



Referencia	Potencia	Temp. Cor	Base	Tipo	Preço
GCE27-4HP	4W	2300K	E27	Garrafa de Cerveja Gold	12,59 €
GCE27-4HPSM				Garrafa de Cerveja Smoked	

## Bulb Decorativa Efeito Chama

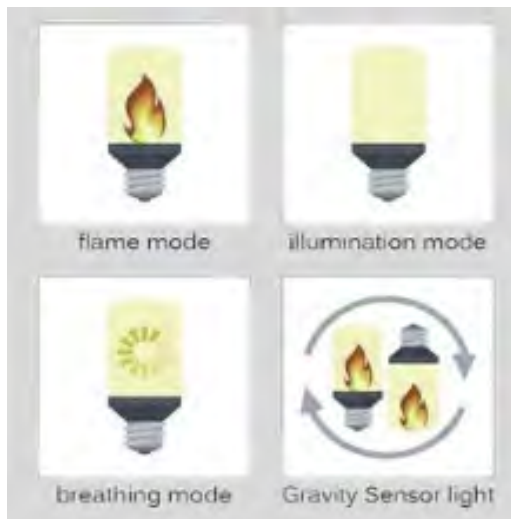

Referencia	Potencia	Temp. Cor	Base	Dimensão	Preço
CHAMA/E27	4W-6W	1900K	E27	Ø63x150mm	5,57 €

## Bulb A60 RGB+CCT TUYA



Referencia	Potencia	Temp. Cor	Base	Dimensão	Preço
044/RGB-WT	10W	RGB+CCT	E27	Ø63x150mm	8,52 €

# 7 Corns



Referencia	Potencia	Lumens	Temp. Cor	Voltagem	Base	Dimensão	Led Filament
159/30W-4U	30W	3000	6000K	85 - 265VAC	E27	Ø73x255mm	2835-152
160/30WW-4U		2600	3000K				

## CORNS

Especificações técnicas:

Material:

Plástico/Vidro

Equivalencia

ECO 18W / 26w / 60w / 80w

Cobertura

Transparente

360°  
IP  
40FP  
0,60CRI  
>80

Referencia	Potencia	Lumens	Temp. Cor	Voltagem	Base	Dimensão	Preço	Preço
159/W3U	7W	600	6000K	85 - 265VAC	E27	Ø43x130mm	2835-36	2,69 €
159/WW3U			3000K	85 - 265VAC	E27	Ø43x130mm	2835-36	
160/WW3U	12W	1020	3000K	85 - 265VAC	E27	Ø53x175mm	2835-60	3,41 €
160/WW4U	20W	1700	3000K	85 - 265VAC	E27	Ø73x220mm	2835-96	4,27 €
159/30W-4U	30W	3000	6000K	85 - 265VAC	E27	Ø73x255mm	2835-152	6,14 €
160/30WW-4U		2600	3000K					

# 7 Down Lights



Referencia	Potencia	Lumens	Temp. Cor	Voltagem	Corte	Dimensão	Led COB
DL-CL12-213-3	11,5W	1200	2700K				1-Cree 1507
DL-CL12-213-4	11,5W	1200	4000K				

Referencia
DL-FIX SF224

## Downlight 3W



119/3B

Especificações técnicas:

Material:	Alumínio / Branco
Funcionalidade	Direcionavel
Cobertura	Transparente
Tipo drive:	Externo

EPISTAR



Referencia	Potencia	Lumens	Temp. Cor	Voltagem	Corte	Dimensão	Led	Preço
119/3		220	6000K					
119/3B	3W		6000K	85 - 265VAC	Ø55mm	Ø68xX22mm	1	6,61 €
120/3		200	3000K					
120/3B			3000K					
119/5RGB	5W		R G B					10,13 €

## Downlight 5W

Especificações técnicas:

Material:	Alumínio Anodizado
Funcionalidade	Direcionavel
Cobertura	Transparente
Tipo drive:	Externo

EPISTAR



Referencia	Potencia	Lumens	Temp. Cor	Voltagem	Corte	Dimensão	Led	Preço
120/5	5W	420	3000K	85 - 265VAC	Ø98mm	Ø108x66mm	5	9,66 €

## Downlight 9W

Especificações técnicas:

Material:	Alumínio Anodizado
Funcionalidade	Direcionavel
Cobertura	Transparente
Tipo drive:	Externo

EPISTAR



Referencia	Potencia	Lumens	Temp. Cor	Voltagem	Corte	Dimensão	Led	Preço
119/9	9W	800	6000K	85 - 265VAC	Ø65mm	Ø85x95mm	9	7,00 €

## Downlight 15W

Especificações técnicas:

Material:	Alumínio Anodizado
Funcionalidade	Direcionavel
Cobertura	Transparente
Tipo drive:	Externo

EPISTAR



Referencia	Potencia	Lumens	Temp. Cor	Voltagem	Corte	Dimensão	Led	Preço
123	15W	1500	6000K	85 - 265VAC	Ø130mm	Ø140x90mm	15	27,06 €
124		1350	3000K					29

## Downlight Retangular 30W





Referencia	Potencia	Lumens	Temp. Cor	Voltagem	Corte	Dimensão	Led COB	Preço
199/W	30W	2700	6000K	85 - 265VAC	225X125mm	243X152mm	2	39,60 €
199/WW		2600	3000K					
201/W	40W	3600	6000K	85 - 265VAC	223X125mm	240X150mm	3	42,08 €
201/WW		3500	3000K					

## Downlight Gimble 15W/25W





Referencia	Potencia	Lumens	Temp. Cor	Voltagem	Corte	Dimensão	Led COB	Preço
217/PW	15W	1500	4000K	200 - 265VAC	Ø95mm	Ø110X125mm	1	18,78 €
216/PW	25W	2500						35,23 €

## Mini-Downlights

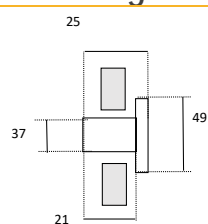

Obs: Ideal p/ aplicar no exterior

Referencia	Potencia	Lumens	Temp. Cor	Voltagem	Corte	Dimensão	Preço
648/3R-4	3W	280	4000K	85 - 265VAC	Ø37mm	Ø49mm	3,59 €
648/3R-3	3W	280	3000K				

## Mini-Downlights

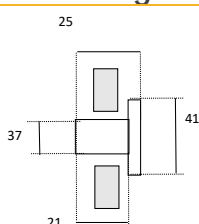

Obs: Ideal p/ aplicar no exterior

Referencia	Potencia	Lumens	Temp. Cor	Voltagem	Corte	Dimensão	Preço
648/3Q-4	3W	280	4000K	85 - 265VAC	Ø37mm	41*41mm	2,25 €
648/3Q-3	3W	280	3000K				

## Downlight 20W/30W

Especificações técnicas:

Material:	Alumínio Lac. Br.
Funcionalidade	Fixo
Cobertura	Transparente
Tipo Drive	Externo



Referencia	Potencia	Lumens	Temp. Cor	Voltagem	Corte	Dimensão	Led COB	Preço
137/N	20W	1800	6000K	200 - 265VAC	Ø188mm	Ø198x100mm		38,03 €
137/NWW	20W	1650	3000K		Ø188mm	Ø198x100mm		38,03 €
174/N	30W	2700	6000K	200 - 265VAC	Ø210mm	Ø230x74mm		48,15 €
174/NWW	30W	2200	3000K		Ø210mm	Ø230x74mm		48,15 €

## Downlight 3CCT Dimmable 7W/15W/25W IP 44

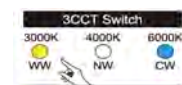

Referencia	Potencia	Lumens	Temp. Cor	Voltagem	Corte	Dimensão	Led SMD	Preço
DL-7W-CCT+D	7W	700	3CCT	175 - 265VAC	Ø68 - 80mm	Ø95X57,5mm	1	7,27 €
DL-15W-CCT+D	15W	1500	3CCT		Ø120 - 130mm	Ø145XØ65mm	1	11,30 €
DL-25W-CCT+D	25W	2500	3CCT		Ø195 - 215mm	Ø244XØ84,5mm	1	18,77 €

## Aro para Downlight 3CCT



Referencia	Côr	Preço
DLR-7N		1,32 €
DLR-15N	Nickel	1,89 €
DLR-25N		3,05 €

## Downlight 8W/15W/25W IP 54



### Especificações técnicas:

Material:	Alumínio Lac. Branco
Funcionalidade	Fixo
Cobertura	Transparente
Tipo Drive	Interno



Referencia	Potencia	Lumens	Temp. Cor	Voltagem	Corte	Dimensão	Led SMD	Preço
DL-PL8W-6	8W	720	6000K		Ø75mm	Ø95XØ51mm		5,08 €
DL-PL8W-4	8W	700	4000K		Ø75mm	Ø95XØ51mm		
DL-PL15W-6	15W	1350	6000K	85 - 265VAC	Ø110mm	Ø140XØ62mm		7,43 €
DL-PL15W-4	15W	1300	4000K		Ø110mm	Ø140XØ62mm		
DL-PL25W-6	25W	2250	6000K		Ø180mm	Ø225XØ90mm		13,22 €

## Downlight 18W 3CCT IP 54



Ângulo Abertura	120
Temperatura de Côr	CCT (3000+4000+6000K)
Classe de Protecção	Class II
Voltagem	170-260V
Material	PC

CRI	>80
Índice de Protecção	IP54
Índice de Impacto	IK08
Factor Potência	>0,5
Certificado	TUV, CE, RoHS, ErP, IEC

Referencia	Modelo	Lumens	Temp. Cor	Voltagem	Corte	Dimensão	Preço
DOVE-R5	Redondo	500			Ø75-90mm	Ø95X26mm	4,00 €
DOVE-R18	Redondo	1800	3CCT	170 - 260VAC	Ø140-160mm	Ø170X26mm	7,76 €
DOVE-S18	Quadrado				140-160mm	170X170x26mm	
FRAME-R18	Redondo						1,55 €
FRAME-S18	Quadrado						



## Modulo Downlight 8W/11,5W

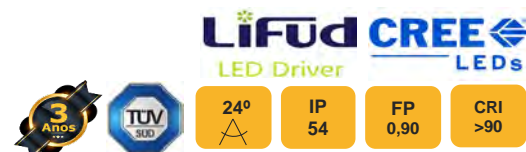

Referencia	Potencia	Lumens	Temp. Cor	Voltagem	Corte	Dimensão	Led COB	Preço
DL-CL08-213-3	8W	800	2700K	200 - 265VAC		63XØ54	1-Cree 1304	12,04 €
DL-CL08-213-4	8W	800	4000K					
DL-CL12-213-3	11,5W	1200	2700K					
DL-CL12-213-4	11,5W	1200	4000K					

## Downlight Direcionavel 2X15W



Referencia	Potencia	Lumens	Temp. Cor	Voltagem	Corte	Dimensão	Led COB	Preço
DL-CL15-213-4	15W	1500	4000K	200 - 265VAC	72X152mm	92X172mm	1	27,38 €
DL-CL15-213-3	15W	1500	3000K					

## Fixador/Base para modulo led 8/11,5W

Especificações técnicas:

Material:	Policarbonato Lac.
Funcionalidade	Direcionavel
Corte	Ø72mm
Dimensão	92mmX92mm

Aplicavel a todas as Referências:  
Lâmpada não incluída.  
Compatível com:  
- DL-CL08-213 e DL-CL12-213 /  
GU10 e MR16

Referencia	Preço
DL-FIX SF221	2,69 €

Especificações técnicas:

Material:	Policarbonato Lacado Branco
Funcionalidade	Direcionavel
Corte	72X152mm
Dimensão	92mmX172mm

Referencia	Preço
DL-FIX SF222	5,05 €

## Fixador/Base para modulo led 8/11,5W

Especificações técnicas:

Material: Policarbonato Lacado Branco  
 Funcionalidade Fixo  
 Ø70mm  
 Ø90mm

Referencia	Preço
DL-FIX SF224	2,08 €

Especificações técnicas:

Material: Policarbonato Lacado Branco  
 Funcionalidade Fixo  
 Corte Ø80mm  
 Dimensão Ø100mm

Referencia	Preço
DL-FIX SF225	1,78 €

Especificações técnicas:

Material: Policarbonato Lacado Branco  
 Funcionalidade Direcionavel  
 Corte Ø70mm  
 Dimensão Ø90mm

Referencia	Preço
DL-FIX SF226	2,71 €

## Fixador/Base para modulo led 8/11,5W

Especificações técnicas:

Material: Ceramica  
 Funcionalidade Fixo  
 Corte Ø70mm  
 Dimensão Ø85x30mm

Referencia	Preço
DL-FIX SF227	3,68 €

Aplicavel a todas as Referências:  
 Lâmpada não incluida.  
 Compativel com:  
 - DL-CL08-213 e DL-CL12-213 /  
 GU10 e MR16

Especificações técnicas:

Material:  
 Funcionalidade Fixo  
 Corte Ø70mm  
 Dimensão 85x85x30mm

Referencia	Preço
DL-FIX SF228	3,68 €

# 8 AR-111



Referencia	Potencia	Lumens	Temp. Cor	Voltagem	Base	Dimensão	Led
128/3	13W	1160	3000K	175 - 265VAC	GU10	Ø111x93mm	2

## AR-111 GU10



LIFUD  
LED Driver  
EPISTAR

Côr	Branco
Angulo de Abertura	60
Material	ABS + PS Plastic
CRI	80
Quantidade de Led's	1 pcs COB
Indice de Protecção	IP40
Fator de Potência	0,9

Referencia	Potencia	Lumens	Temp. Cor	Voltagem	Base	Dimensão	Preço
127/3	12W	1100	3000K	200 - 265VAC	GU10	Ø111x80mm	10,71 €
127/4			4000K				
127/6			6000K				



## AR-111



Côr	Cinza
Angulo de Abertura	24
Material	Aluminium + PS Plastic
CRI	80
Quantidade de Led's	2 pcs COB
Indice de Protecção	IP40
Fator de Potência	0,9

Referencia	Potencia	Lumens	Temp. Cor	Voltagem	Base	Dimensão	Preço
128/3	13W	1160	3000K	175 - 265VAC	GU10	Ø111x93mm	16,29 €

## AR-111 G5.3



EPISTAR

Côr	Cinza
Angulo de Abertura	45
Material	Aluminium + PS Plastic
CRI	80
Quantidade de Led's	1 pcs COB
Indice de Protecção	IP40
Fator de Potência	0,9

Referencia	Potencia	Lumens	Temp. Cor	Voltagem	Base	Dimensão	Preço
139/6	13W	1350	6000K	100 - 265VAC	G 5.3	Ø111x60mm	17,00 €
139/3		1250	3000K				

## AR-111



LIFUD  
LED Driver  
EPISTAR

Côr	Branco
Angulo de Abertura	60
Material	Aluminium + PS Plastic
CRI	80
Quantidade de Led's	1 pcs COB
Indice de Protecção	IP40
Fator de Potência	0,9

Referencia	Potencia	Lumens	Temp. Cor	Voltagem	Base	Dimensão	Preço
218/3	12W	1200	3000K	200 - 265VAC	G 5.3	Ø111x70mm	16,99 €

## AR-111



EDISON

Côr	Branco
Angulo de Abertura	60
Material	Aluminium + PS Plastic
CRI	80
Quantidade de Led's	9 pcs HP
Indice de Protecção	IP40
Fator de Potência	0,9

Referencia	Potencia	Lumens	Temp. Cor	Voltagem	Base	Dimensão	Preço
140/18B	18W	1680	3000K	200 - 265VAC	G 5.3	Ø111x60mm	17,50 €

# 10 PAR 20-30-38



Referencia	Potencia	Lumens	Temp. Cor	Voltagem	Base	Dimensão	Led COB
189/P20W	8W	800	5000K	175 - 265VAC	E27	Ø63x82mm	8
189/P20WW		720	3000K				

## PAR20

Especificações técnicas:

Material: Alumínio  
 Equivalencia: 30W Halogéneo  
 Cobertura: Acrílico Transparente

EPISTAR



Referencia	Potencia	Lumens	Temp. Cor	Voltagem	Base	Dimensão	Led COB	Preço
189/P20W	8W	800	5000K	175 - 265VAC	E27	Ø63x82mm	8	10,27 €
189/P20WW		720	3000K					

## PAR30

Especificações técnicas:

Material: Alumínio  
 Equivalencia: 50W Halogéneo  
 Cobertura: Acrílico Transparente

BRIDGELUX  
The Magic of Light™

Referencia	Potencia	Lumens	Temp. Cor	Voltagem	Base	Dimensão	Led COB	Preço
189/P30W	15W	1400	6000K	85 - 265VAC	E27	Ø93x101mm	1	17,85 €

# 11 R7S

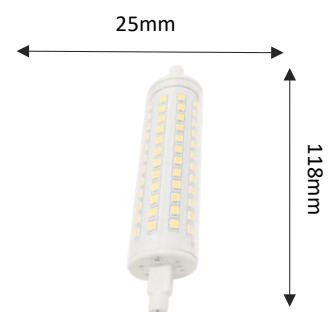
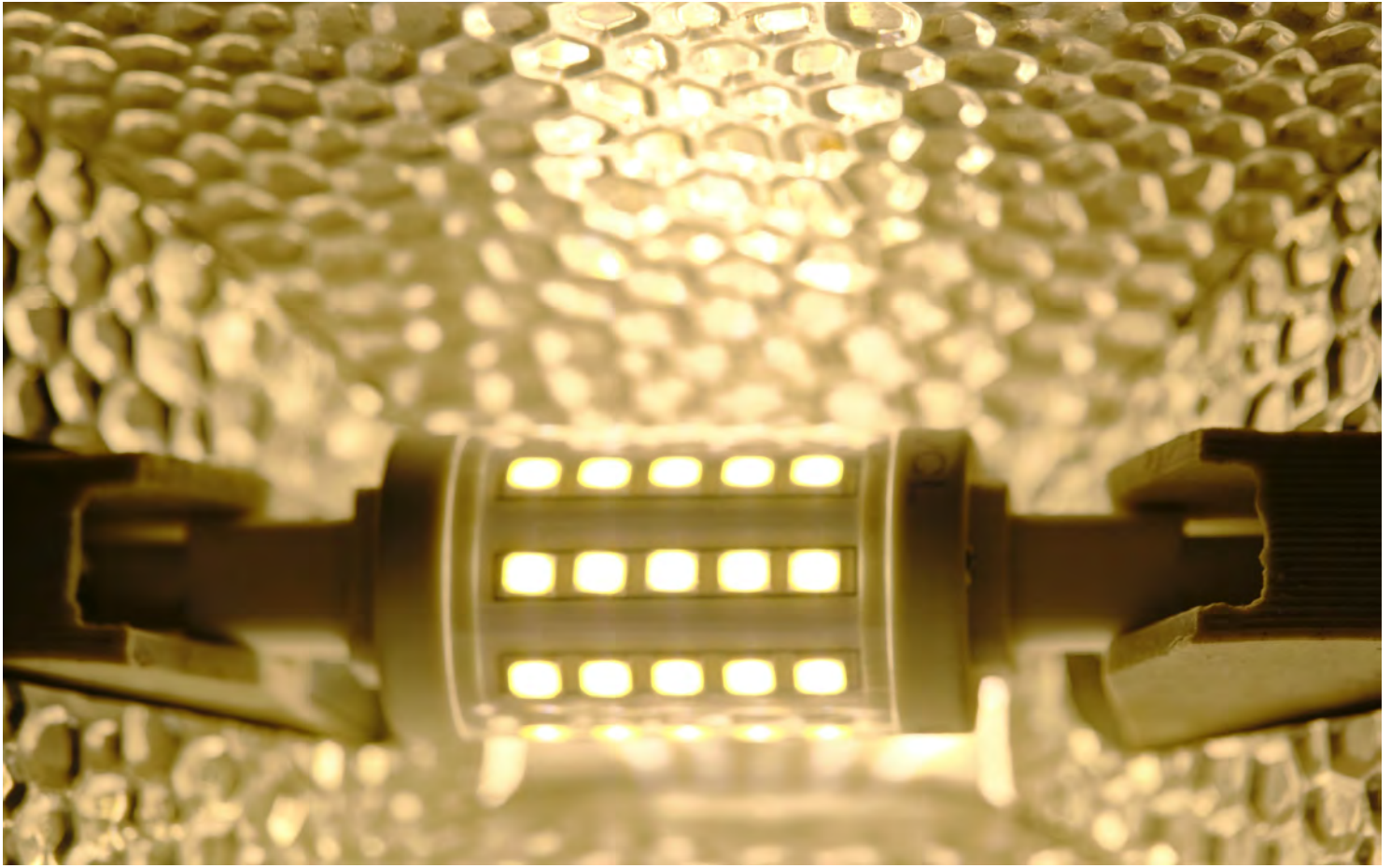

Referencia	Potencia	Lumens	Temp. Cor	Voltagem	Base	Dimensão	Led COB
075/118-6		2200	6000K				
075/118-4	18W	2200	4000K	200 - 265VAC	R7S	Ø25x118mm	2835-96
075/118-3		2100	2700K				

## R7S 78 mm

Especificações técnicas:

Material: Alumínio/Plástico  
 Equivalencia: 40W Halogéneo  
 Cobertura: Não

270°  
△IP  
20FP  
0,62CRI  
>80

Referencia	Potencia	Lumens	Temp. Cor	Voltagem	Base	Dimensão	Led SMD	Preço
167/N	5W	460	6000K	85 - 265VAC	R7S	78x54X35mm	3014-64	7,43 €
168/N		400	3000K					

## R7S 78 mm

Especificações técnicas:

Material: Alumínio/Plástico  
 Equivalencia: 75W Halogéneo  
 Cobertura: Não

270°  
△IP  
20FP  
0,62CRI  
>80

Referencia	Potencia	Lumens	Temp. Cor	Voltagem	Base	Dimensão	Led SMD	Preço
167/860	8W	650	6000K	85 - 265VAC	R7S	78x54X35mm	2835-32	7,43 €
167/830		600	3000K					

## R7S 78mm

Especificações técnicas:

Material: Plástico  
 Equivalencia: 75W Halogéneo  
 Cobertura: Plástico

360°  
△IP  
40FP  
0,95CRI  
>80

Referencia	Potencia	Lumens	Temp. Cor	Voltagem	Base	Dimensão	Led SMD	Preço
167/380	5W	500	6000K	200 - 265VAC	R7S	Ø25x78mm	2835-24	5,63 €

## R7S 118 mm

Especificações técnicas:

Material: Alumínio/Plástico  
 Equivalencia: 150W Iodetos Met.  
 Cobertura: Não

270°  
△IP  
40FP  
0,95CRI  
>80

Referencia	Potencia	Lumens	Temp. Cor	Voltagem	Base	Dimensão	Led SMD	Preço
075/N	10W	850	6000K	200 - 265VAC	R7S	118x54X35mm	3014-90	10,13 €
076/N		780	3000K					
075/D	 10W	850	6000K	200 - 265VAC	R7S	118x54X35mm	3014-90	15,75 €

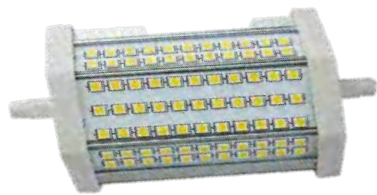

## R7S 118 mm

Especificações técnicas:

Material: Alumínio/Plástico  
 Equivalencia: 300W Halogéneo  
 Cobertura: Não

270°  
IP  
40FP  
0,95CRI  
>80

Referencia	Potencia	Lumens	Temp. Cor	Voltagem	Base	Dimensão	Led SMD	Preço
075/860	16W	1450	6000K	200 - 265VAC	R7S	118x45X40mm	2835-77	13,05 €
075/840		1400	4000K					

## R7S 118mm

Especificações técnicas:

Material: Plástico  
 Equivalencia: 150W Halogéneo  
 Cobertura: Plástico

360°  
IP  
40FP  
0,90CRI  
>80

Referencia	Potencia	Lumens	Temp. Cor	Voltagem	Base	Dimensão	Led SMD	Preço
075/380	10W	1200	6000K	200 - 265VAC	R7S	Ø25x118mm	2835-96	6,56 €
075/380.84		1150	4000K					
076/380		1080	3000K					
075/118-6	18W	2200	6000K	200 - 265VAC	R7S	Ø25x118mm	2835-96	10,16 €
075/118-4		2200	4000K					
075/118-3		2100	2700K					

## R7S 135mm

Especificações técnicas:

Material: Plástico  
 Equivalencia: 150W Iodetos Metálicos  
 Cobertura: Plástico

360°  
IP  
40FP  
0,90CRI  
>80

Referencia	Potencia	Lumens	Temp. Cor	Voltagem	Base	Dimensão	Led SMD	Preço
075/135-6	14W	1600	6000K	200 - 265VAC	R7S	Ø22x135mm	2835-120	6,93 €
075/135-3		1500	3000K					

# 12 PLC G24/E27

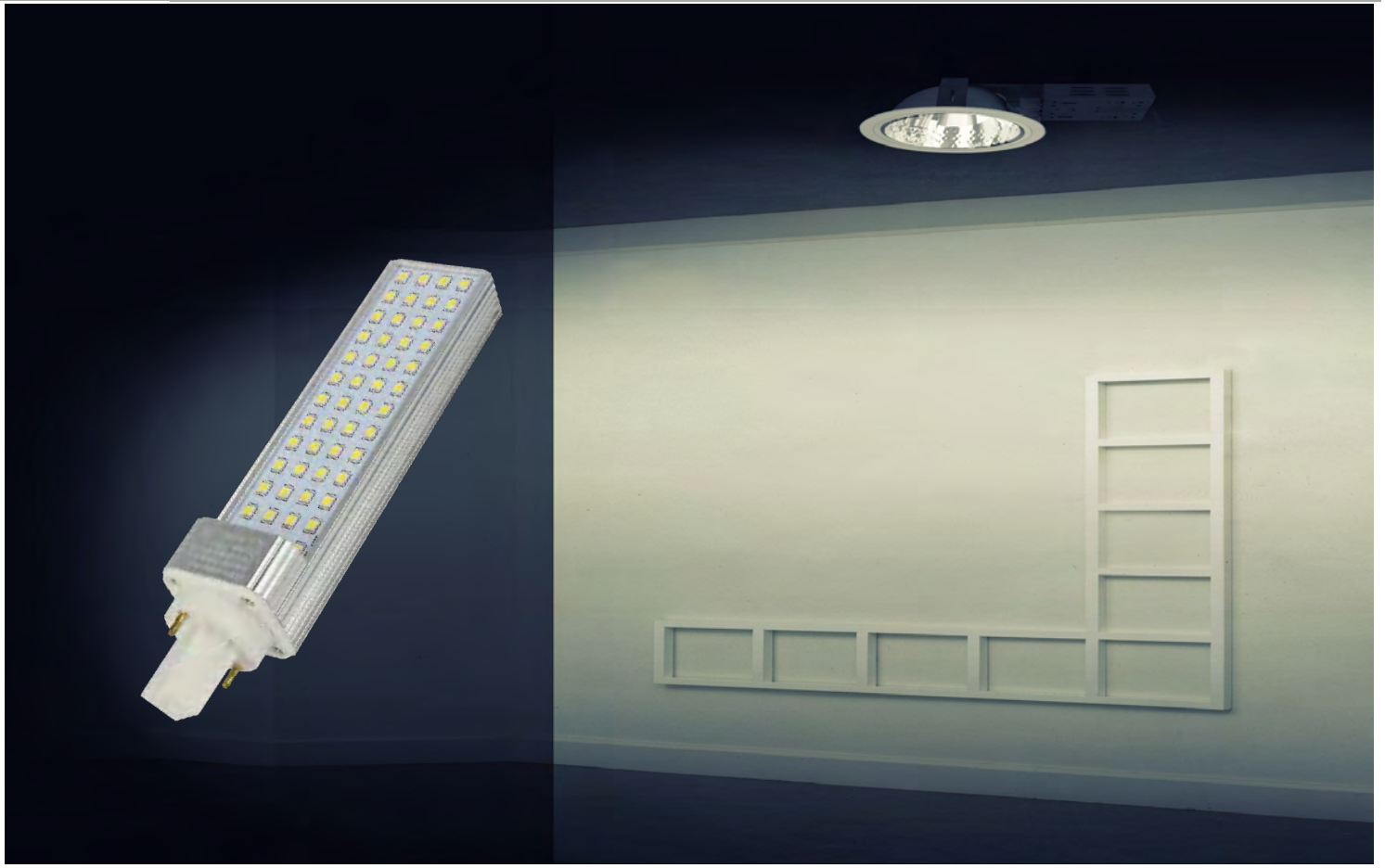

Referencia	Potencia	Lumens	Temp. Cor	Voltagem	Base	Dimensão	Led SMD
147/N	13W	1150	3000K	85 - 265VAC	G24	160X35X35mm	3014-120
147/NE27		1150	3000K		E27		

## PLC G24

Especificações técnicas:

Material: Alumínio  
Cobertura: Sim



Referencia	Potencia	Lumens	Temp. Cor	Voltagem	Base	Dimensão	Led SMD	Preço
104/840 104/860	7W	700	4000K 6000K	85 - 265VAC	G24	144X34mm	2835-40	4,53 €
146/840 146/860	12W	1200	4000K 6000K	85 - 265VAC	G24	172X34mm	2835	4,93 €

## PLC G24

Especificações técnicas:

Material: Alumínio  
Equivalencia: ECO 18W  
Cobertura: Não



Referencia	Potencia	Lumens	Temp. Cor	Voltagem	Base	Dimensão	Led SMD	Preço
131/N 131/G24	10W	950 870	3000K 3000K	85 - 265VAC	G24	145X35X35mm	3014-96 2835-48	9,56 € 8,33 €
146/830	12W	1270	3000K	85 - 265VAC	G24	160X35X35mm	2835-60	8,78 €
147/N	13W	1150	3000K	85 - 265VAC	G24	160X35X35mm	3014-120	10,28 €

## PLC E27

Especificações técnicas:

Material: Alumínio  
Equivalencia: ECO 18W  
Cobertura: Não



Referencia	Potencia	Lumens	Temp. Cor	Voltagem	Base	Dimensão	Led SMD	Preço
147/NE27	13W	1150	3000K	85 - 265VAC	E27	160X35X35mm	3014-120	10,28 €

# 13 T5-T8-Reguas



## Reguas para Armários CCT+Sensor PIR

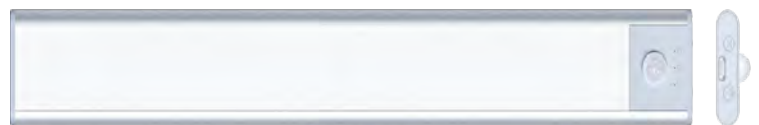

Referencia	Potencia	Lumens	Temp. Cor	Voltagem	Cobertura	Dimensão	Preço
F1004	1,5W	150	CCT	5V	Opalina	300X45X12mm	11,14 €

## T5 60 / 90 / 120



Obs: Fornecido c/ cabo de ligação, topo, união e fixador

Especificações técnicas:

Material:

Alumínio/Plástico

Base:

T5

120°



IP

44

FP

0,90

CRI

&gt;80

Referencia	Potencia	Lumens	Temp. Cor	Voltagem	Cobertura	Dimensão	Led SMD	Preço
161+ 162+	9W	900	4000K 6000K	175 - 265VAC	Transparente Opalina	600x22x33mm	2835-48	4,74 €
161/90 162/90	14W 12W	1100	4000K 6000K	175 - 265VAC	Transparente Opalina	900x22x33mm	2835-72	5,94 €
161/120 162/120	18W	1800	4000K 6000K	175 - 265VAC	Transparente Opalina	1200x22x33mm	2835-96	6,95 €

## T8 45

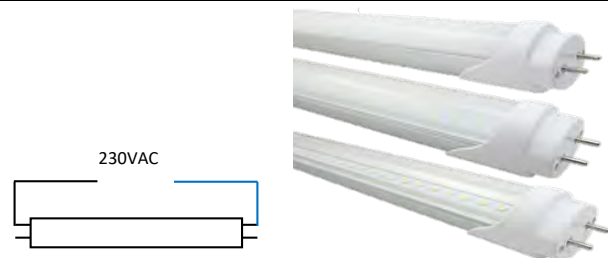
Especificações técnicas:

Material:

Alumínio/Plástico

Base:

T8

120°



IP

44

FP

0,90

CRI

&gt;80

Referencia	Potencia	Lumens	Temp. Cor	Voltagem	Cobertura	Dimensão	Led SMD	Preço
150/45PWR	7W	675	4000K	85 - 265VAC	Transparente	Ø26x450mm	2835-36	5,33 €

## T8 90

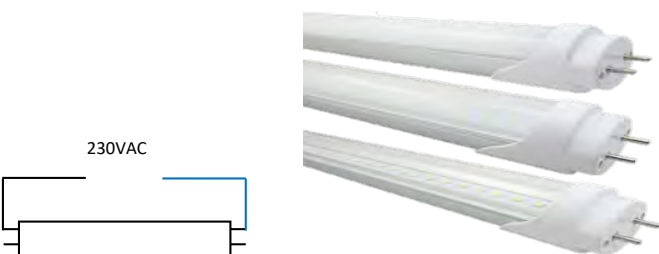
Especificações técnicas:

Material:

Alumínio/Plástico

Base:

T8

120°



IP

44

FP

0,90

CRI

&gt;80

Referencia	Potencia	Lumens	Temp. Cor	Voltagem	Cobertura	Dimensão	Led >SMD	Preço
150/860 150/860OP	14W 14W	1400 1400	6000K 6000K	85 - 265VAC 85 - 265VAC	Transparente Opalina	Ø26x900mm	2835-72	3,96 €

## T8 100

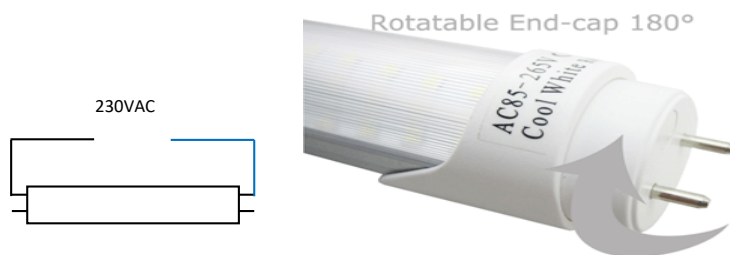
Especificações técnicas:

Material:

Alumínio/Plástico

Base:

T8

120°



IP

44

FP

0,90

CRI

&gt;80

Referencia	Potencia	Lumens	Temp. Cor	Voltagem	Cobertura	Dimensão	Led SMD	Preço
150/WR	14W	1500	6000K	85 - 265VAC	Opalino	Ø26x1000mm	2835-80	6,53 €

Obs: Lampada c/ topos rotativos.

## T8 60 / 120 / 150

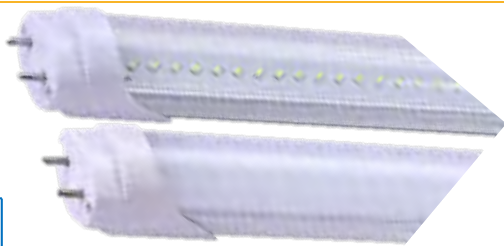
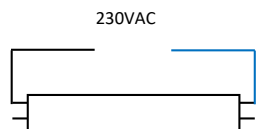
Especificações técnicas:

Material:

Alumínio/Plástico

Base:

T8

120°



IP

44

FP

0,90

CRI

&gt;80

Referencia	Potencia	Lumens	Temp. Cor	Voltagem	Cobertura	Dimensão	Led SMD	Preço
151/C+	9W	1150	6000K	85 - 265VAC	Transparente	Ø26x600mm	3014-96	12,78 €
151/OP+		1150	6000K	85 - 265VAC	Opalina			
152/OP+		1000	3000K	85 - 265VAC	Opalina			
153/C+	18W	2200	6000K	85 - 265VAC	Transparente	Ø26x1200mm	3014-192	20,88 €
154/C+		2050	3000K	85 - 265VAC	Transparente			
154/OP+		2050	3000K	85 - 265VAC	Opalina			
155/C+	22W	2880	6000K	85 - 265VAC	Transparente	Ø26x1500mm	3014-240	26,28 €
156/C+		2400	3000K	85 - 265VAC	Transparente			
155/OP+		2880	6000K	85 - 265VAC	Opalina			
156/OP+		2400	3000K	85 - 265VAC	Opalina			

## T8 60 / 120 / 150

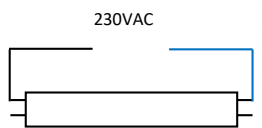
Especificações técnicas:

Material:

Alumínio/Plástico

Base:

T8

120°



IP

44

FP

0,90

CRI

&gt;80

Obs: Designação "R" Lamp. c/ topos rotativos.

Referencia	Potencia	Lumens	Temp. Cor	Voltagem	Cobertura	Dimensão	Led SMD	Preço
151/860	9W	900	6000K	85 - 265VAC	Transparente	Ø26x600mm	2835-48	4,22 €
151/840		800	4000K	85 - 265VAC	Transparente			4,22 €
151/860R		900	6000K	85 - 265VAC	Transparente			4,84 €
151/840R		800	4000K	85 - 265VAC	Transparente			4,84 €
151/860OP		900	6000K	85 - 265VAC	Opalina			4,22 €
151/840OP		800	4000K	85 - 265VAC	Opalina			4,22 €
153/860	18W	1800	6000K	85 - 265VAC	Transparente	Ø26x1200mm	2835-104	4,50 €
153/840		1600	4000K	85 - 265VAC	Transparente			4,50 €
153/860R		1800	6000K	85 - 265VAC	Transparente			6,65 €
153/840R		1600	4000K	85 - 265VAC	Transparente			6,65 €
153/860OP		1800	6000K	85 - 265VAC	Opalina			4,50 €
153/840OP		1600	4000K	85 - 265VAC	Opalina			4,50 €
155/860	22W	2300	6000K	85 - 265VAC	Transparente	Ø26x1500mm	2835-120	5,97 €
155/840		2100	4000K	85 - 265VAC	Transparente			5,97 €
155/840R		2100	4000K	85 - 265VAC	Transparente			7,56 €
155/860OP		2300	6000K	85 - 265VAC	Opalina			5,97 €
155/840OP		2100	4000K	85 - 265VAC	Opalina			5,97 €

## T8 60 / 120 / 150



## Especificações técnicas:

Material:

Nano

Base:

T8

Obs: Lamp. c/ topos rotativos.



Referencia	Potencia	Lumens	Temp. Cor	Voltagem	Cobertura	Dimensão	Led SMD	Preço
151/OP-R6	9W	1000	6000K	85 - 265VAC	Opalina	Ø32x600mm	2835-48	6,85 €
153/OP-R6	18W	2000	6000K	85 - 265VAC	Opalina	Ø32x1200mm	2835-96	8,37 €
155/OP-R6	22W	2400	6000K	85 - 265VAC	Opalina	Ø32x1500mm	2835-120	10,15 €

## T8 60 / 120 / 150



## Especificações técnicas:

Material:

Alumínio/Plástico

Base:

T8

Obs: Lamp. c/ topos rotativos. Ligação num dos topos.



Referencia	Potencia	Lumens	Temp. Cor	Voltagem	Cobertura	Dimensão	Led SMD	Preço
151/ECO6-R	9W	900	6000K	85 - 265VAC	Opalina	Ø32x600mm	2835-48	4,52 €
151/ECO4-R		850	4000K	85 - 265VAC	Opalina			
153/ECO6-R	18W	1900	6000K	85 - 265VAC	Opalina	Ø26x1200mm	2835-96	6,24 €
153/ECO4-R		1800	4000K	85 - 265VAC	Opalina			
155/ECO6-R	22W	2300	6000K	85 - 265VAC	Opalina	Ø26x1500mm	2835-120	7,23 €
155/ECO4-R		2200	4000K	85 - 265VAC	Opalina			

## T8 60 / 120 / 150 Especiais



## Especificações técnicas:

Material:

Alumínio/Plástico

Base:

T8

Obs: Própria para colocar em Vitrines de talhos, peixaria, fruta, pastelaria.

Temp. Trab. -40° a 50°C



Referencia	Potencia	Lumens	Temp. Cor	Voltagem	Cobertura	Dimensão	Led SMD	Preço
151/MEAT		850	PINK	85 - 265VAC	Opalina			
151/FISH	9W	850	6000K	85 - 265VAC	Opalina	Ø32x600mm	2835-48	6,12 €
151/PAST		850	2700	85 - 265VAC	Opalina			
151/VEG		850	4000K	85 - 265VAC	Opalina			
153/MEAT		1700	PINK	85 - 265VAC	Opalina			
153/FISH	18W	1700	6000K	85 - 265VAC	Opalina	Ø26x1200mm	2835-100	8,82 €
153/PAST		1700	2700	85 - 265VAC	Opalina			
153/VEG		1700	4000K	85 - 265VAC	Opalina			
155/MEAT		2200	PINK	85 - 265VAC	Opalina			
155/FISH	22W	2200	6000K	85 - 265VAC	Opalina	Ø26x1500mm	2835-132	10,94 €
155/PAST		2200	2700	85 - 265VAC	Opalina			
155/VEG		2200	4000K	85 - 265VAC	Opalina			

## Reguas para Armários



Referencia	Potencia	Lumens	Temp. Cor	Voltagem	Cobertura	Dimensão	Preço
REG/BTL18	18W	1530	4000K	85 - 265VAC	Opalina	610mm	6,04 €
REG/BTL36	36W	3060	4000K	85 - 265VAC	Opalina	1200mm	8,12 €
REG/BTL42	42W	3570	4000K	85 - 265VAC	Opalina	1500mm	10,22 €

## Reguas para Armários CCT+Sensor PIR



- Ⓜ 1. Press 3sec, turn ON/OFF  
2. Press 1sec, change the mode Night/Day/Sensor

- Ⓢ 1. Short press, change the color temperature, 6500K-4000K-3000K respectively  
2. Long press, stepless dimming



Referencia	Potencia	Lumens	Temp. Cor	Voltagem	Cobertura	Dimensão	Preço
F1004	1,5W	150	CCT	5V	Opalina	300X45X12mm	11,14 €



# 14 Armaduras de Emergência

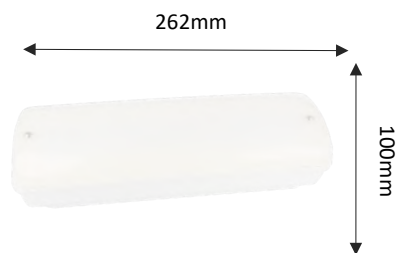

Referência	Potência	Lumens	Temp. Cor	Voltagem	IP	Dimensão	Led SMD
EM121N	3W	200		220 - 240VAC	65	262x100x46mm	5730-6

## Armaduras de Emergência



### Especificações técnicas:

Modo: Permanente / Não-Permanente  
 Bateria: Nickel-Cadmium 3.6V /1.8 Ah  
 Indicador: RED LED---charging; Green LED--AC power  
 Tempo duração: Mais de 3 horas  
 Construção: Fire-Retardant ABS Casing and Plate;PC Diffuser  
 Instalação: Superfície

Referencia	Potencia	Lumens	Temp. Cor	Voltagem	IP	Dimensão	Led SMD	Preço
<b>EM121N</b>	<b>3W</b>	200		220 - 240VAC	65	262×100×46mm	5730-6	<b>23,59 €</b>



### Especificações técnicas:

Modo: Não-Permanente  
 Bateria: Ni-Cd battery 3.6V/1.8Ah  
 Indicador: Green LED--AC power on,Red LED--charging  
 Tempo de duração: 3 horas  
 Construção: Fire-Retardant ABS Casing and Plate;PS Diffuser.  
 Instalação: Superfície

Referencia	Potencia	Lumens	Temp. Cor	Voltagem	IP	Dimensão	Led SMD	Preço
<b>EM116N-A1</b>	<b>3W</b>	200		200 - 240VAC	40	238x80x40mm	5730-6	<b>17,25 €</b>



### Especificações técnicas:

Modo: Permanente  
 Bateria: Nickel-Cadmium 3.6V /1.0Ah  
 Indicador: Green LED- Charging  
 Tempo de duração: Mais de 3 horas  
 Construção: Aluminum body, Acrylic Plate  
 Instalação: Superfície & Suspenso

Referencia	Potencia	Lumens	Temp. Cor	Voltagem	IP	Dimensão	Led SMD	Preço
<b>EM211M</b>	<b>3W</b>	200		200-240VAC	20	310x225x35 mm	2835-15	<b>34,25 €</b>

# 15 Armaduras Estanque

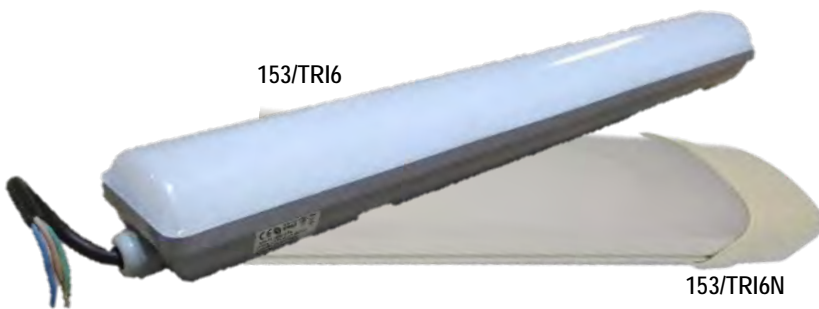

Referencia	Potencia	Lumens	Temp. Cor	Voltagem	IP	Dimensão	Led SMD
153/TRI6	40W	3800	6000K				
153/TRI6N	35W	4120	6000K	85 - 265VAC	Opalina	1230X70X80mm	2835-224
153/TRI4	40W	3800	4000K				

## Triproof 60 / 120 / 150cm IP65

LED INSIDE



## Especificações técnicas:

Material: Policarbonato

Temperatura de trabalho: 50°C ~ - 30°C

Obs: Fornecido c/ Kit de fixação. Led em Barra de Alumínio

## Modelo N



Referencia	Potencia	Lumens	Temp. Cor	Voltagem	Cobertura	Dimensão	Led SMD	Preço
151/TRI6	20W	1640	6000K	85 - 265VAC	Opalina	630x70x80mm	2835-120	23,62 €
153/TRI6	40W	3800	6000K	85 - 265VAC	Opalina	1230X70X80mm	2835-224	35,52 €
153/TRI6N	35W	4120	6000K					
153/TRI4	40W	3800	4000K					
155/TRI6	50W	4263	6000K	85 - 265VAC	Opalina	1530x70x80mm	2835-288	45,16 €
155/TRI4	50W	4162	4000K					



# 16 Lâmpadas de Piscina



**TYPE 316**  
Stainless Steel

Referencia	Potencia	Temp. Cor	Numens	Voltagem	Base	Dimensão
067/ZOE	15W (15±1 W)	R G B	R-300 G-650 B-150	12VAC/DC	PAR56	Ø177x105mm
CR/ZOE3	Até 20 Par 56			12 - 24VAC		120X70X24mm

PAR 56 RGB

TYPE **316**  
Stainless Steel

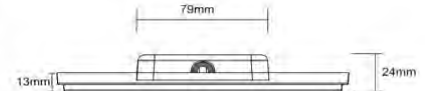
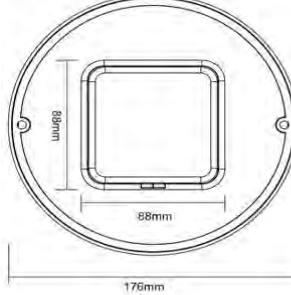
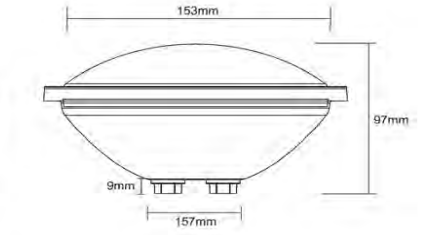
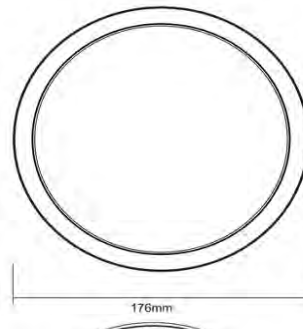

MODELO  
**UT**  
Ultra Thin

120°  
IP 68  
FP 0,90  
CRI >80

Referencia	Potencia	Temp. Cor	Lumens	Voltagem	Base	Funcionamento	LED	Preço
P56/35-6	35W	6000K	3500	12VAC/DC	PAR56	2 - FIOS	COB -1	96,41 €
053/CWW		3000K	3200					87,07 €
P56/25-6		6000K	2500			2 - FIOS	COB-1	84,74 €
P56/25-RGB	25W	R G B	750-850	12VAC/DC	PAR56	PL- RGB	SMD 2835	87,46 €
P56/UT25-RGB		R G B	750-850					93,87 €
067/ZOE	15W (15±1 W)	R G B	R-300 G-650 B-150	12VAC/DC	PAR56	CR-ZOE3	SMD 2835	87,46 €

PAR 56

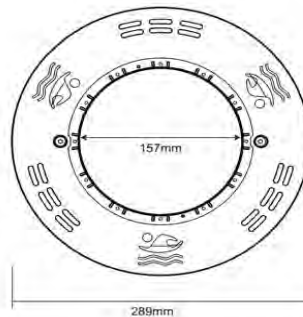

120°  
IP 68  
FP 0,90  
CRI >80

Referencia	Potencia	Temp. Cor	Lumens	Voltagem	Base	Funcionamento	Led SMD	Preço
SPL/15-RGB	15W	R G B				PL- RGB		90,32 €
SPL/30-6	30W	6000K	2500	12VAC/DC	Superficie	2 - FIOS	2835	100,97 €
SPL/15-6	15W	6000K	1250					88,80 €

Iluminação SPA

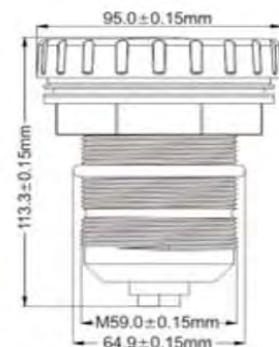

120°  
IP 68  
FP 0,90  
CRI >80

Referencia	Potencia	Temp. Cor	Lumens	Voltagem	Base	Funcionamento	LED	Preço
SPA/3-6	3W	6000K	350	12VAC/DC		2 - FIOS	36 - 2835	62,16 €
SPA/3-RGB		R G B	320			4 - FIOS		67,23 €

## Controlador RGB P/Par 56

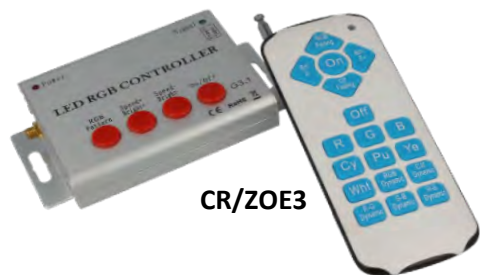

CR/ZOE3



PL-RGB

Obs. Controlo, Par 56, marca LOFL.O comando incluído, permite controlar até um máximo de 20 lâmpadas e 100mt de cabo, por cada transformador. Instalação, c/ 2 fios, que serão os mesmos para alimentação do controlador.

Referencia	Potencia		Voltagem	Dimensão	Preço
CR/ZOE3	Até 20 Par 56		12 - 24 VAC	120X70X24mm	51,75 €
PL-RGB		Funciona com SPL-15-RGB	12v AC/DC		57,97 €

## Amplificador Par 56



Obs. Numa instalação que ultrapasse as 10 lâmpadas será necessário colocar outro transformador e deverá ser utilizado um amplificador.

### Especificações técnicas:

Material:	Aluminio
Tempo de vida:	30.000H
Funcionalidade	Amplificador

Referencia	Potencia		Voltagem	Dimensão	Preço
629	Até 10 Par 56		12 - 24 VDC	120X70X24mm	47,20 €

## Habitáculo P/Par 56



Obs. IP 68, Compatível com todos os modelos PAR56

Referencia	Utilização	Material	Cabo Alimentação	Dimensão	Preço
HAB/PAR-C	Concreto	ABS	2x1,5mm, L=1,5mt	Ø290x165mm	63,43 €
HAB/PAR-V	Vinil				77,38 €

## Projector Lago Inox IP 68 RGB



098/9W - 098/9RGB

### Especificações técnicas:

Material:	Inox 316
Tempo de vida:	30.000H
Cobertura	Transparente

**EPISTAR**  
TYPE **316**  
Stainless Steel



Referencia	Potencia	Lumens	Temp. Cor	Voltagem	Ligação	Dimensão	Led	Preço
098/3W	3W	250				Ø125X115mm	3	28,29 €
098/6W	6W	400	6000K	12V DC	2 FIOS	Ø125X115mm	6	49,34 €
098/9W	9W	990				Ø145X150mm	9	60,38 €
098/9RGB	9W	489	R G B	12V DC	4 FIOS	Ø145X150mm	9	63,68 €

## Projektor Chão Inox Encastrar IP 68



TYPE **316**  
Stainless Steel

EPISTAR



Referencia	Potencia	Lumens	Temp. Cor	Voltagem	Base / Corte	Dimensão	Led	Preço
099/3-3	3W	300	3000K	230V AC	Ø	Ø55X82mm	1	48,46 €
099/12W	12W	1320	6000K	12V DC	Ø154X92mm	Ø170X95mm	12*1	74,19 €
099/54W	54W	5200	6000K	24V DC	Ø220X135mm	Ø220X135mm	18*3	164,91 €
099/3RGB	3W		R G B	12V DC	Ø70X85mm	Ø90X90mm	3*1	33,87 €

## Projektor Chão Inox Encastrar IP 68

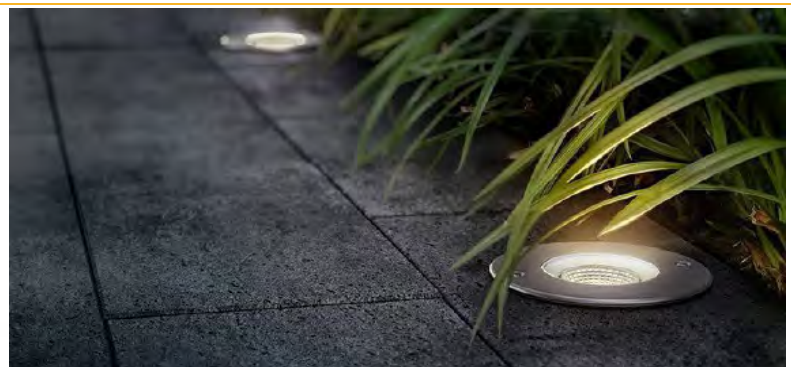

Rotation angle of light plate  $\pm 15^\circ$



304  
STAINLESS STEEL

EPISTAR



Referencia	Potencia	Lumens	Temp. Cor	Voltagem	Base / Corte	Dimensão	Led	Preço
100/3-3	3W	300	3000K	230V	Ø105X140mm	Ø120X140mm	1	38,06 €

## Projektor Exterior Aço Inox Encastrar IP 67

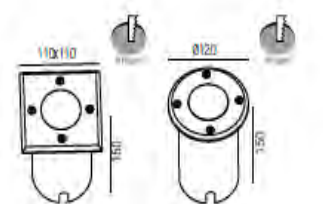

GU10 304  
STAINLESS STEEL

Referencia	IP	IK	Temperatura de Funcionamento	Voltagem	Corte	Dimensão	Preço
FL-GU10R	67	10	-40° - 45°	100 - 240 VAC	Ø105	Ø120 X A150mm	19,42 €
FL-GU10Q					Ø105X105mm	110X110 X A150mm	56



# 17 Projetores Exterior



Referencia	Potencia	Lumens	Temp. Cor	Voltagem	Led SMD
FL-AK30W-6	30W	3000	6000K	175 - 265VAC	2835-36
FL-AK50W-6	50W	5000			2835-66

## Projektor SMD 10W - 200W



Obs: Alumínio Lacado preto, Caixa decorativa, sem Marca.

### Especificações técnicas:

Material:	Alumínio
Tempo de vida:	30.000H
Cobertura:	Vidro
Tipo drive:	Interno



Referencia	Potencia	Lumens	Temp. Cor	Voltagem	IP	Dimensão	Led SMD	Preço
057/ALSMD-6	10W	860	6000K	100 - 265VAC	65	112X84X41mm	2835-20	3,20 €
059/ALSMD-6	30W	2923	6000K	100 - 265VAC	65	186X225X53mm	2835-60	7,68 €
060/ALSMD-3	30W	2800	3000K	100 - 265VAC	65	186X225X53mm	2835-60	7,68 €
100WW/ALSMD-3	100W	8589	3000K	100 - 265VAC	65	297X335X78mm	2835-200	21,00 €
150W/ALSMD-6	150W	12508	6000K	100 - 265VAC	65	395X280X160mm	2835-300	40,95 €
150WW/ALSMD-3	150W	12360	3000K	100 - 265VAC	65	395X280X160mm	2835-300	40,95 €
200WW/ALSMD-3	200W	16320	3000K	100-265VAC	65	425x323x160mm	2835-400	51,63 €

## Projektor SLIM SMD 10W - 200W



Obs: Alumínio Lacado preto, Caixa decorativa, sem Marca.

### Especificações técnicas:

Material:	Alumínio
Tempo de vida:	30.000H
Cobertura:	Vidro
Tipo drive:	Interno



Referencia	Potencia	Lumens	Temp. Cor	Voltagem	IP	Dimensão	Led SMD	Preço
057/ALSMD-6N	10W	860	6000K	175 - 265VAC	65	112X84X41mm	5630-20	3,72 €
058/ALSMD-3N	10W	710	3000K	175 - 265VAC	65	112X84X41mm	5630-20	3,72 €
063/ALSMD-6N	20W	1600	6000K	175 - 265VAC	65	115X87X28mm	5630-40	5,28 €
063/ALSMD-3N	20W	1600	3000K	175 - 265VAC	65	115X87X28mm	5630-40	5,28 €
059/ALSMD-6N	30W	2923	6000K	175 - 265VAC	65	135X175X34mm	5630-60	9,35 €
060/ALSMD-3N	30W	2800	3000K	175 - 265VAC	65	135X175X34mm	5630-60	9,35 €
061/ALSMD-6N	50W	4505	6000K	175 - 265VAC	65	220X180X35mm	5630-100	11,04 €
062/ALSMD-3N	50W	4355	3000K	175 - 265VAC	65	220X180X35mm	5630-100	11,04 €
100W/ALSMD-6N	100W	8589	6000K	175 - 265VAC	65	275X225X45mm	5630-200	22,33 €
200W/ALSMD-6-N	200W	16472	6000K	175 - 265VAC	65	425x325x75mm	5630 400	55,32 €
200W/ALSMD-3-N	200W	16320	3000K	175 - 265VAC	65	425x325x75mm	5630 400	55,32 €

## Projektor Branco SMD 10W - 200W



Obs: Alumínio Lacado branco, Caixa branca, sem Marca.

### Especificações técnicas:

Material:	Alumínio
Tempo de vida:	30.000H
Cobertura:	Vidro
Tipo drive:	Interno



Referencia	Potencia	Lumens	Temp. Cor	Voltagem	IP	Dimensão	Led SMD	Preço
057/ALSMD-6-B	10W	800	6000K	220 - 240VAC	65	112X84X41mm	5630-20	3,72 €
058/ALSMD-3-B	10W	710	3000K	220 - 240VAC	65	112X84X41mm	5630-20	3,72 €
063/ALSMD-6-B	20W	1600	6000K	220 - 240VAC	65	115X87X28mm	5630-40	5,28 €
063/ALSMD-3-B	20W	1600	3000K	220 - 240VAC	65	115X87X28mm	5630-40	5,28 €
059/ALSMD-6-B	30W	2400	6000K	220 - 240VAC	65	135X175X34mm	5630-60	9,35 €
060/ALSMD-3-B	30W	2400	3000K	220 - 240VAC	65	135X175X34mm	5630-60	9,35 €
061/ALSMD-6-B	50W	4000	6000K	220 - 240VAC	65	220X180X35mm	5630-100	11,04 €
062/ALSMD-3-B	50W	4000	3000K	220 - 240VAC	65	220X180X35mm	5630-100	11,04 €
100W/ALSMD-6B	100W	8000	6000K	220 - 240VAC	65	275X225X45mm	5630-200	22,33 €
200W/ALSMD-6B	200W	16472	6000K	220 - 240VAC	65	425x325x75mm	5630 400	55,32 €

## Projektor Branco SMD UGR<19 - Anti Reflexo

### UGR<19



Ângulo Abertura	<b>120</b>
Classe de Protecção	<b>Class I</b>
Material	<b>Puro Alumínio / Vidro Anti-Encandeamento</b>
Certificado	<b>TUV, CE, RoHS, ErP, IEC</b>

CRI	<b>80</b>
Índice de Protecção	<b>IP65</b>
Índice de Impacto	<b>IK 08</b>
Factor Potência	<b>&gt;0,9</b>

Referencia	Potencia	Lumens	Temp. Cor	Voltagem	IP	Dimensão	Led SMD	Preço
057/ALSMD-6-BAR	10W	1000	6000K	200-265VAC	65	118x85x20,5mm	2835-15	7,18 €
058/ALSMD-3-BAR		1000	3000K					
063/ALSMD-6-BAR	20W	2000	6000K	200-265VAC	65	162x115x20,5mm	2835-28	11,16 €
059/ALSMD-6-BAR	30W	3000	6000K	200-265VAC	65	193x138x20,5mm	2835-45	15,73 €
060/ALSMD-3-BAR		3000	3000K					
061/ALSMD-6-BAR	50W	5000	6000K	200-265VAC	65	235x165x20,5mm	2835-70	21,26 €
062/ALSMD-3-BAR		5000	3000K					
100W/ALSMD-6-BAR	100W	10000	6000K	200-265VAC	65	300x220x31mm	2835-140	39,70 €
RGB/30-BAR	30W		R G B	200-265VAC	65	193x138x20,5mm	2835-45	43,13 €

## Projektor Branco SMD UGR<19 - Anti ReflexoC/Sensor Movimento

### UGR<19

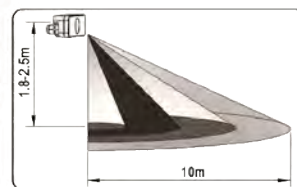
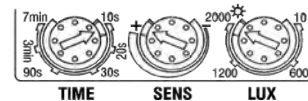

Altura de Instalação: 1,8-2,5Mt

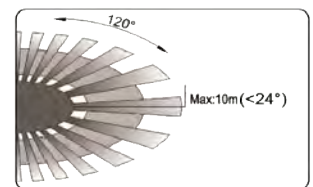

Distância de detecção: Max.10Mt

Referencia	Potencia	Lumens	Temp. Cor	Voltagem	IP	Dimensão	Led SMD	Preço
060/SB	50W	5000	3000K	220 - 240VAC	65	235x225x45mm	2835-70	24,62 €

## Projektor Preto SMD 3CCT UGR<19 - Anti Reflexo C/Sensor Movimento PIR

### UGR<19

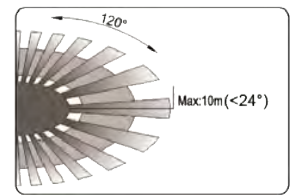
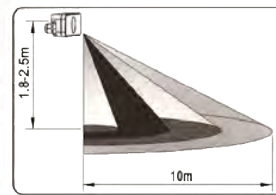
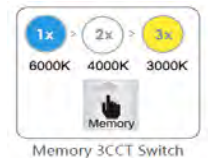

Ângulo Abertura	<b>120</b>
Classe de Protecção	<b>Class I</b>
Material	<b>Puro Alumínio / Vidro Anti-Encandeamto</b>
Certificado	<b>TUV, CE, RoHS, ErP, IEC</b>

CRI	<b>&gt;80</b>
Índice de Protecção	<b>IP65</b>
Índice de Impacto	<b>IK 08</b>
Factor Potência	<b>&gt;0,9</b>

Altura de Instalação: 1,8-2,5Mt

Distância de detecção: Max.10Mt

Referencia	Potencia	Lumens	Temp. Cor	Voltagem	Sensor	Dimensão	Led SMD	Preço
057/SP-CCT	10W	1000	3CCT	200 - 265VAC	PIR	118x85x25mm	2835-30	19,46 €
059/SP-CCT	30W	3000			PIR	195x164x31mm	2835-90	26,44 €

## Projektor de Trabalho a Bateria



Ângulo Abertura	<b>120</b>
Classe de Protecção	<b>Class I</b>
Material	<b>Puro Alumínio / Vidro Temperado</b>
Certificado	<b>TUV, CE, RoHS, ErP, IEC</b>
CRI	<b>80</b>
Índice de Protecção	<b>IP54</b>
Índice de Impacto	<b>IK 08</b>
Factor Potência	<b>&gt;0,9</b>

### Funcionamento

50% luz: 6 Horas

100% luz: 4 Horas

Vermelho \* Azul Luz de Aviso



Referencia	Potencia	Lumens	Temp. Cor	Bateria	Carregamento	Dimensão	USB	Preço
FL-10W-6	10W	800	6000K	5000mAH	10 Horas	190x116x190mm	DC 5V	22,66 €
FL-30W-6	30W	2400		20000mAH		235x150x225mm		45,41 €

## Projektor Policarbonato Bridgelux 10W/30W/50W/80W/100W



### Especificações técnicas:

Material:	Policarbonato/Vidro
Tempo de vida:	30.000H
Equivalencia	10W/30W/50W
Cobertura	Halógeno Transparente



Referencia	Potencia	Lumens	Temp. Cor	Voltagem	IP	Dimensão	Led COB	Preço
057/PLB 058/PLB	10W	1200 1100	6000K 3000K	200 - 265VAC	65	133X179X57mm 133X179X57mm	1	22,33 €
059/PLB 060/PLB	30W	3600 3500	6000K 3000K	200 - 265VAC	65	178X215X81mm 178X215X81mm	1	47,95 €
061/PLB 062/PLB	50W	6000 5900	6000K 3000K	200 - 265VAC	65	194X252X95mm 194X252X95mm	1	75,35 €

## Projektor Policarbonato 12/24V Bridgelux 10W/20W/30W/50W



### Especificações técnicas:

Material:	Policarbonato/Vidro
Tempo de vida:	30.000H
Equivalencia	10W/20W/30W/50W
Cobertura	Halógeno Transparente



Referencia	Potencia	Lumens	Temp. Cor	Voltagem	IP	Dimensão	Led COB	Preço
057/12PB	10W	1200				133X179X57mm	1	23,09 €
063/12PB	20W	2400				180X165X80mm	1	44,90 €
059/12PB	30W	3600	6000K	12/24 DC	65	178X215X81mm	1	59,62 €
061/12PB	50W	6000				194X252X95mm	1	86,14 €

## Projektor Policarbonato RGB 10W / 30W



### Especificações técnicas:

Material:	Policarbonato/Vidro
Tempo de vida:	30.000H
Cobertura	Halógeno Transparente



Referencia	Potencia	Lumens	Temp. Cor	Voltagem	IP	Dimensão	Led COB	Preço
178/PLM	10W		R G B	200 - 265VAC	65	133X180X80mm	1	32,98 €
178/30PLM	30W		R G B	200 - 265VAC	65	178X215X81mm	1	70,02 €

## Projektor Preto 90°



Ângulo Abertura **90**

Classe de Protecção **Class I**

Material **Puro Alumínio / Lentes em PC**

Certificado **TUV, CE, RoHS, ErP, IEC**

CRI **>80**

Índice de Protecção **IP65**

Índice de Impacto **IK 08**

Factor Potência **>0,9**

Referencia	Potencia	Lumens	Temp. Cor	Voltagem	Dimensão	Led SMD	Preço
FL-AK30W-6	30W		6000K	175 - 265VAC		2835-36	10,26 €
FL-AK50W-6	50W					2835-66	12,56 €



Ângulo Abertura **90**

Classe de Protecção **Class I**

Material **Puro Alumínio / Lentes em PC**

Certificado **TUV, CE, RoHS, ErP, IEC**

CRI **>80**

Índice de Protecção **IP65**

Índice de Impacto **IK 08**

Factor Potência **>0,9**

Referencia	Potencia	Lumens	Temp. Cor	Voltagem	Dimensão	Led SMD	Preço
FL-DK50W-CCT	50W	5000	CCT	175-265V	210x160x43,6mm	2835-84	17,45 €

## Projektor a Bateria



Ângulo Abertura **120**

Classe de Protecção **Class I**

Material **Puro Alumínio / Vidro Temperado**

Certificado **TUV, CE, RoHS, ErP, IEC**

CRI **80**

Índice de Protecção **IP54**

Índice de Impacto **IK 08**

Factor Potência **>0,9**



Referencia	Potencia	Lumens	Temp. Cor	Bateria	Carregamento	Dimensão	USB	Preço
FAAS7	7W	1200	CCT	7800mAH	10 Horas	175x175x67mm	DC 5V	29,07 €
FAAS12	12W	1800		10400mAH	10 Horas	205x205x73mm	DC 5V	36,51 €

# 18 Iluminação de Estádio

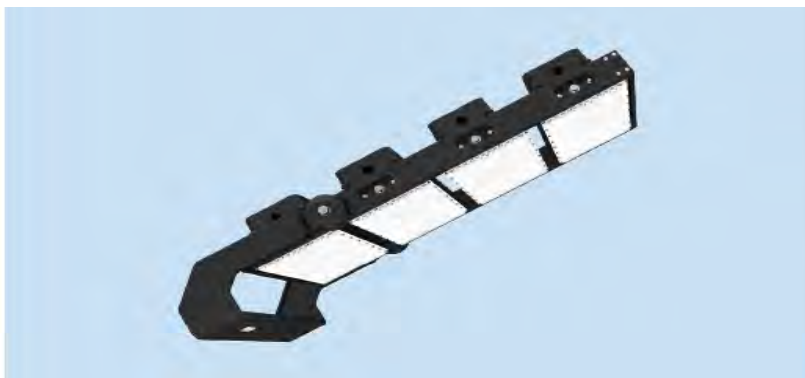

Referencia	Potencia	Lumens	Temp. Cor	Voltagem	Dimavel	
LE-5-600W	500W	84 000	5000K	90-305VAC	Sim	Disponivel

# LED Stadium Light

**140**

LM/W

IP66

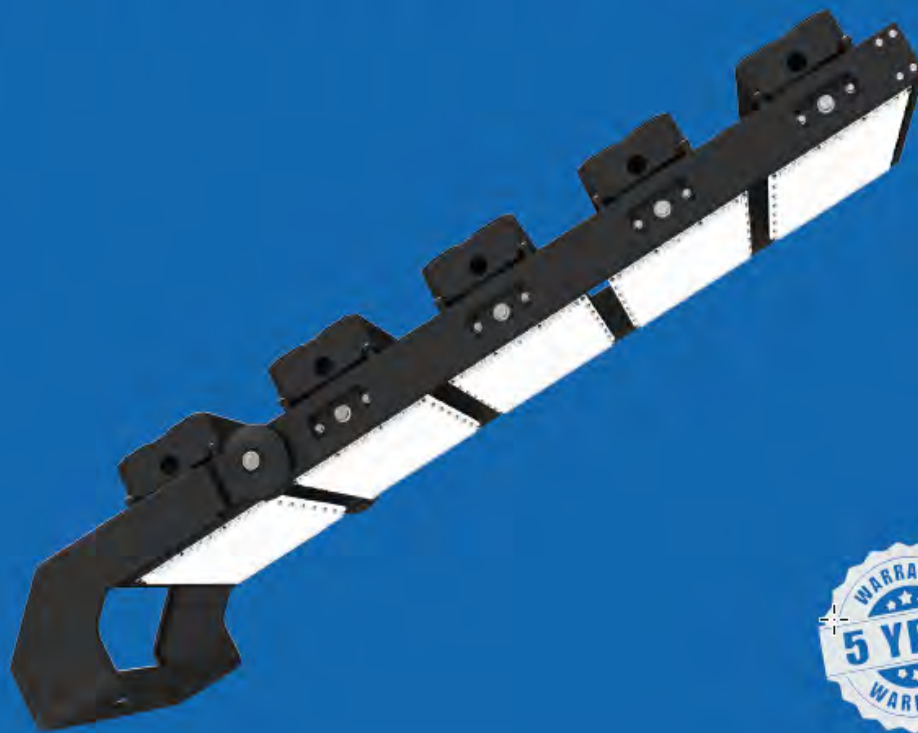

Ângulo Abertura	90°
Material	Pure Aluminium
Certificado	CE, RoHS

CRI	80
Índice de Protecção	IP67
Factor Potência	>0,95

Referencia	Potencia	Lumens	Temp. Cor	Voltagem	Dimavel	Preço	
LE-5-600W	600W	84 000	5000K	90-305VAC	sim	717.97 €	Disponível Por Encomenda
LE-5-1000W	1000W	140 000	6000K			1 428.33 €	



# 19 Iluminação de Rua



Referencia	Potencia	Lumens	Temp. Cor	Sensor	Bateria	Dimensão	Led SMD
LRS/15W-6S	15W	1500	6000K		4,2V,15,4AH	450x225x50mm	3030-28
LRS/30W-6S	30W	3000	6000K	PIR	12,6V, 14AH	670x320x50mm	3030-56
LRS/50W-6S	50W		6000K			789x367x63,5	3030-120

## Painel de Rua Solar com Sensor



Ninguém na área a luz acende a 1/3 da potencia.

Quando a aproximação acende a 100%

<b>Ângulo Abertura</b>	<b>120</b>
<b>Instalação</b>	<b>3-4 Mt</b>
<b>Tempo Carga</b>	<b>8 Horas</b>
<b>Material</b>	<b>Pure Aluminium</b>

<b>CRI</b>	<b>80</b>
<b>Índice de Protecção</b>	<b>IP65</b>
<b>Factor Potência</b>	<b>&gt;0,9</b>
<b>Certificado</b>	<b>CE, RoHS</b>

Referencia	Potencia	Lumens	Temp. Cor	Painel Solar	Bateria	Dimensão	Led SMD	Preço
LRS/15W-6S	15W	1500		Policristalino	4,2V, 15,4AH	450x225x50mm	3030-28	86,80 €
LRS/30W-6S	30W	3000	6000K	Monocristalino	12,6V, 14AH	670x320x50mm	3030-56	219,97 €
LRS/50W-6S	50W	7500		Monocristalino		789x367x63,5	3030-120	262,07 €

## Iluminação de Rua



### Especificações técnicas:

Material:	Alumínio
Tempo de vida:	30.000H

**PHILIPS**

120°	IP 65	FP 0,95	CRI >80
------	-------	---------	---------

Referencia	Potencia	Lumens	Temp. Cor	Voltagem	Base	Dimensão	Led SMD	Preço
LR/80W	80W	8 000	6000K	85-265V	Cabo	280x320x75mm	3030	98,51 €
LR/150W-6	150W	15 000				310x400x75mm	3030	137,00 €

# 20 Iluminação de Jardim e Solar

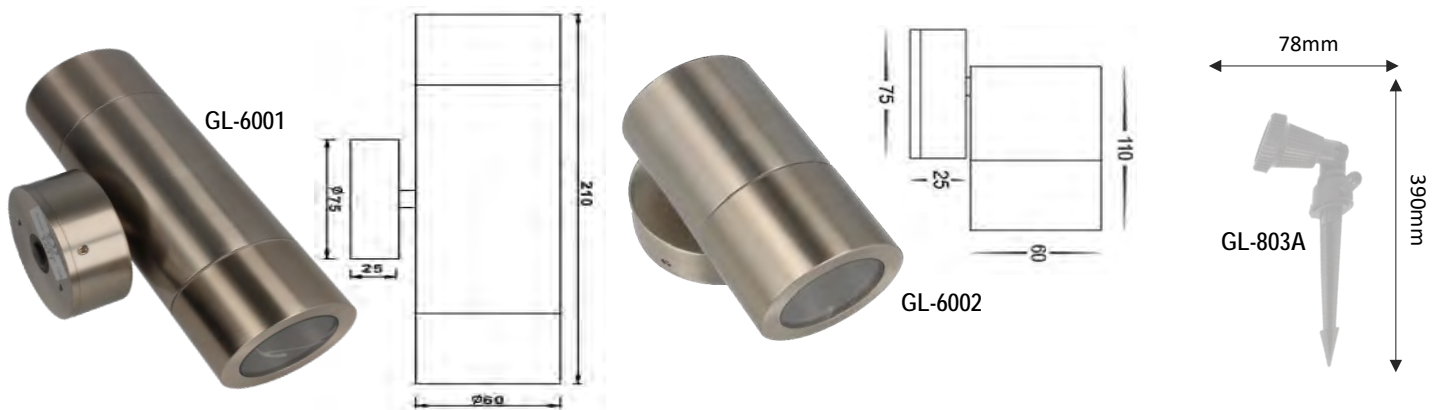

Referencia	Potencia	Base	IP	Material
GL-803A	220 - 240V Max.35W	GU10	65	Nylon+Plastic
GL-6001	220 - 240V Max.35W	GU10	65	316 Stainless steel, Tempered glass
GL-6002	220 - 240V Max.35W	GU10	65	316 Stainless steel, Tempered glass

## Led Jardim 1 x GU10

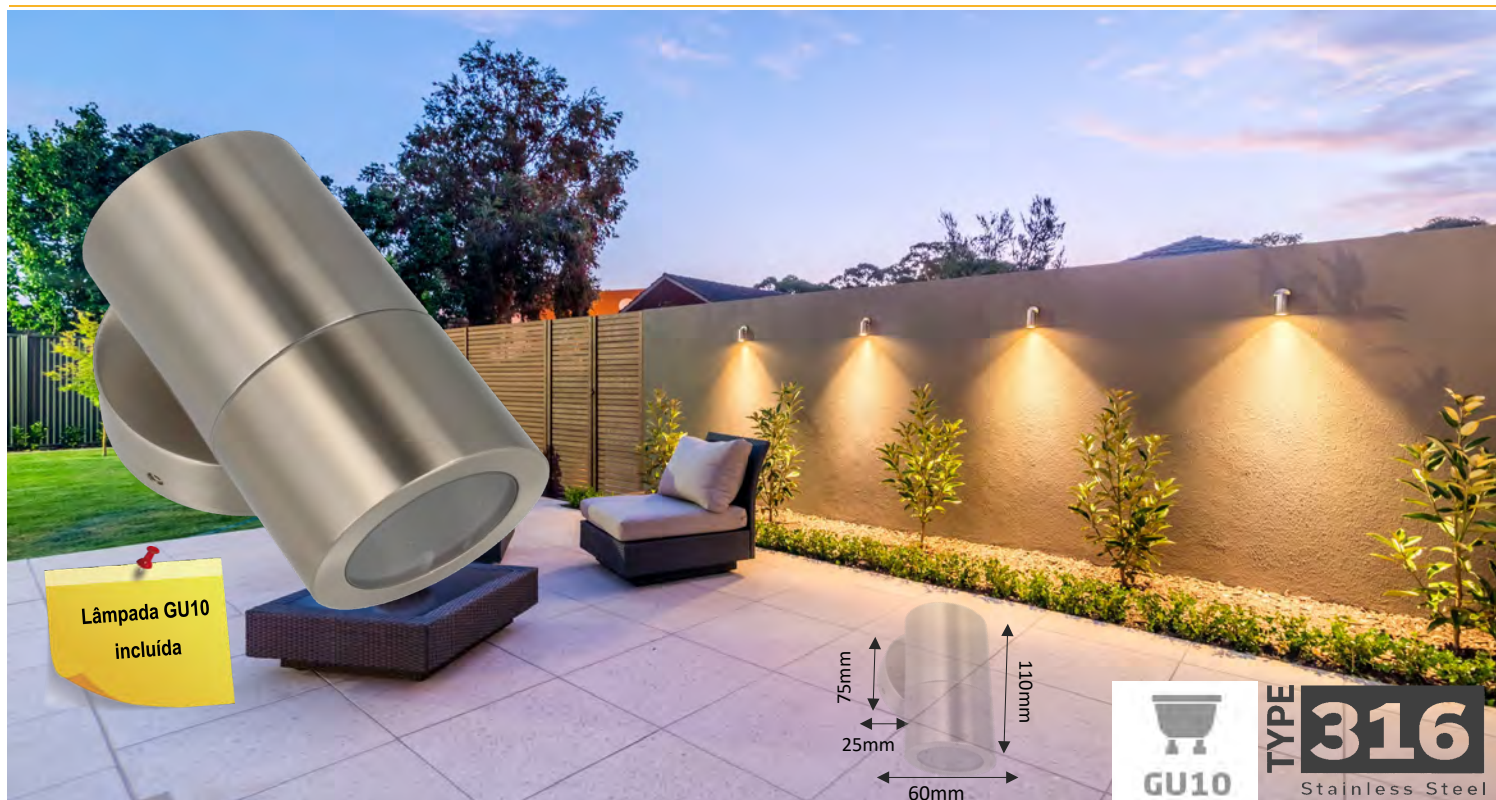

Referencia	Potencia	Base	IP	Material	Preço
GL-6002	220 - 240V Max.35W	GU10	65	316 Stainless steel, Tempered glass	52,95 €

## Led Jardim 2 x GU10

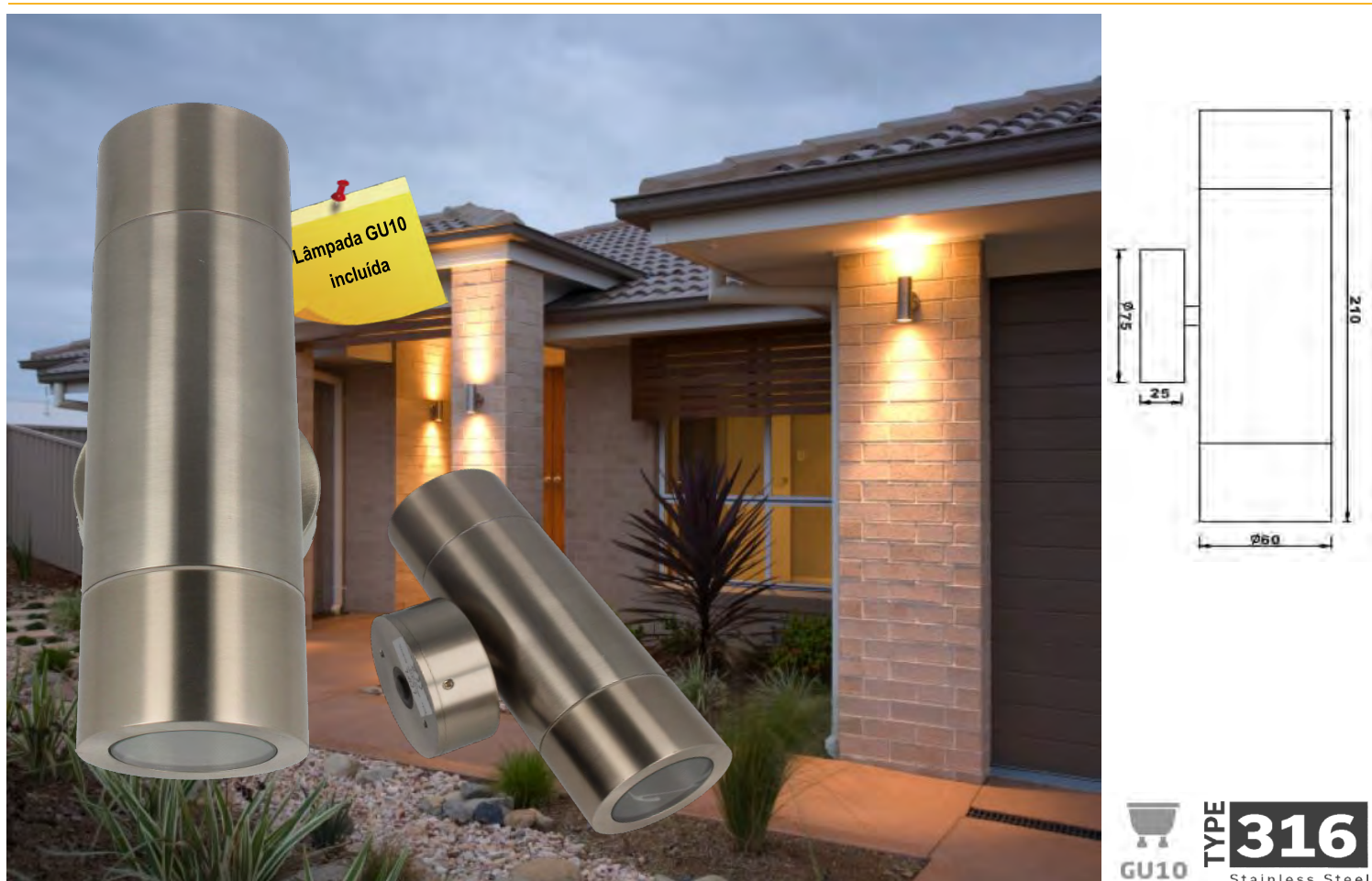

Referencia	Potencia	Base	IP	Material	Preço
GL-6001	220 - 240V Max.35W	GU10	65	316 Stainless steel, Tempered glass	60,82 €

## Led Jardim 3W - 7W

Especificações técnicas:

Material: Alumínio  
Tipo drive: Interno



Referencia	Potencia	Lumens	Temp. Cor	Voltagem	Base	Dimensão	LED	Preço
685/W	3W	300	6000K	85 - 265VAC	Cabo	Ø75 x L250mm	COB-1	16,03 €
686/W	7W	700	6000K	85 - 265VAC	Cabo	Ø95 x L275mm	COB-1	22,82 €

## Led Jardim



GL-803A



GL-0481



GU10

Potência	Até 35W
Voltagem	210-265V
Base	GU10

Índice de Protecção	IP 65
Côr	Preto
Certificado	CE, RoHS,ErP

Referencia	Material	Dimensão	Preço
GL-803A	Nylon+Plastic	78x390mm	7,34 €
GL-0481	Aluminium+Plastic	65x268,5mm	16,60 €

## Led Jardim

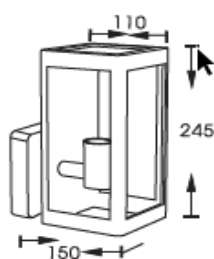

Potência	Até 60W
Voltagem	210-265V
Material	Die-Cast Aluminium + PC Lens
Voltagem	220-240V
Base	E27
Índice de Protecção	IP 65
Dimensões	245x110x150mm
Côr	Cinzeno Escuro
Certificado	CE, RoHS,ErP



Referencia

WALL/3007P

Preço

28,99 €

69



Potência	12W
Kelvins	3 CCT (3000-4000-6000K)
Lumens	840lm
Voltagem	220-240V
Material	Die-Cast Aluminium + PC Lens
Quantidade de Led's	SMD
CRI	>80
Índice de Impacto	IK 08
Índice de Protecção	IP54
Dimensões	240x106,5x65mm
Côr	Cinzeno Escuro
Certificado	CE, RoHS,ErP



"L" Cover



"L2" Cover

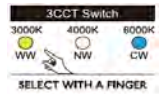

Referencia

WALL/3302-L  
WALL/3302-L2

Preço

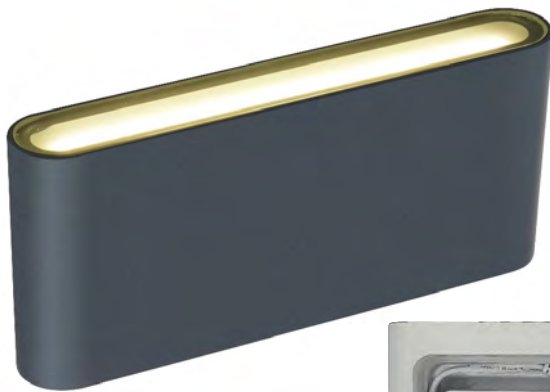
31,69 €  
33,95 €

Potência	12W
Kelvins	3 CCT (3000-4000-6000K)
Lumens	680lm
Voltagem	175-265V
Material	Aluminium + Glass
Quantidade de Led's	16 x 2835 SMD Lens
CRI	>80
Índice de Impacto	IK 08
Índice de Protecção	IP54
Dimensões	175x90x29mm
Côr	Cinzeno Escuro
Certificado	CE, RoHS,ErP

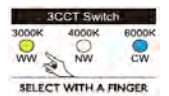
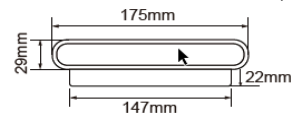

Referencia

Wall/1109C

Preço

36,48 €

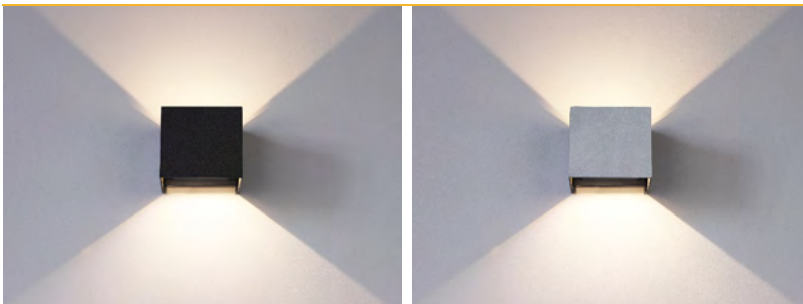

Potência	6W
Kelvins	3 CCT (3000-4000-6000K)
Lumens	360lm
Voltagem	175-265V
Material	Die-Cast Aluminium + PC Lens
Quantidade de Led's	2 x COB
CRI	>80
Índice de Impacto	IK 08
Índice de Protecção	IP54
Dimensões	101x101mm
Côr	Cinzeno Escuro
Certificado	CE, RoHS,ErP

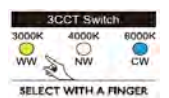
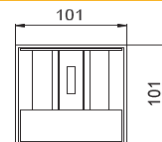

Referencia

Wall/1102C  
Wall/1102B

Preço

21,11 € 70

## Balizadores Jardim



Potência	10W
Kelvins	3000K
Lumens	700lm
Voltagem	220-240V
Material	Die-Cast Aluminium + PC
CRI	>80
Índice de Protecção	IP54
Dimensões	Ø160 x 300mm
Côr	Cinzento Escuro
Certificado	CE, RoHS,ErP



Referencia	Lumens	Temp. Cor	Preço
GL-6701RGBW		<b>R G B</b> +3000K	58,88 €
GL-6701WW	700	3000K	35,49 €

## Parede Jardim

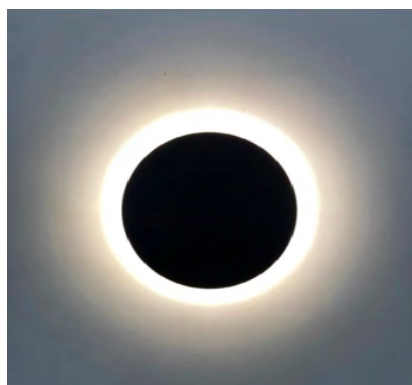

Potência	7W
Kelvins	3000K
Lumens	550lm
Voltagem	175-265V
Material	Die-Cast Aluminium + PC
CRI	>80
Índice de Protecção	IP54
Dimensões	Ø135 x L40mm
Côr	Cinzento Escuro
Certificado	CE, RoHS,ErP

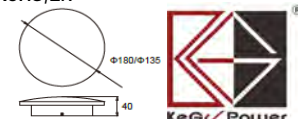

Referencia	Preço
WALL/1003-3	31,53 €



Potência	6W
Kelvins	3000K
Lumens	450lm
Voltagem	175-265V
Material	Die-Cast Aluminium + PC
CRI	>80
Índice de Protecção	IP54
Dimensões	Ø135 x L40mm
Certificado	CE, RoHS,ErP



Referencia	Côr	Preço
WALL/1009-3	Preto	29,20 €
WALL/1009-3B	Branco	

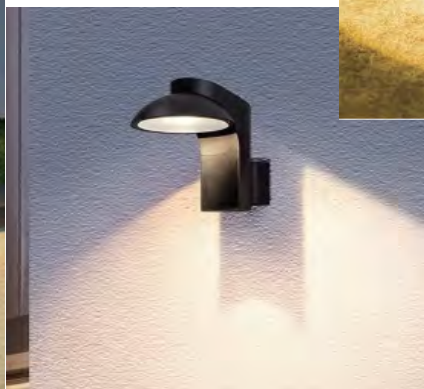
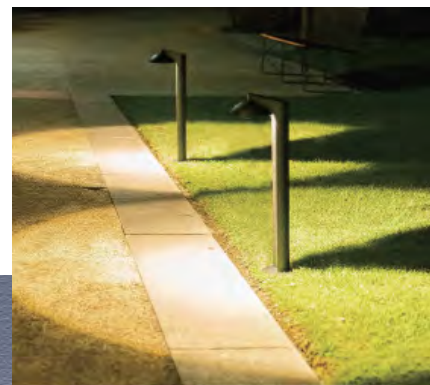
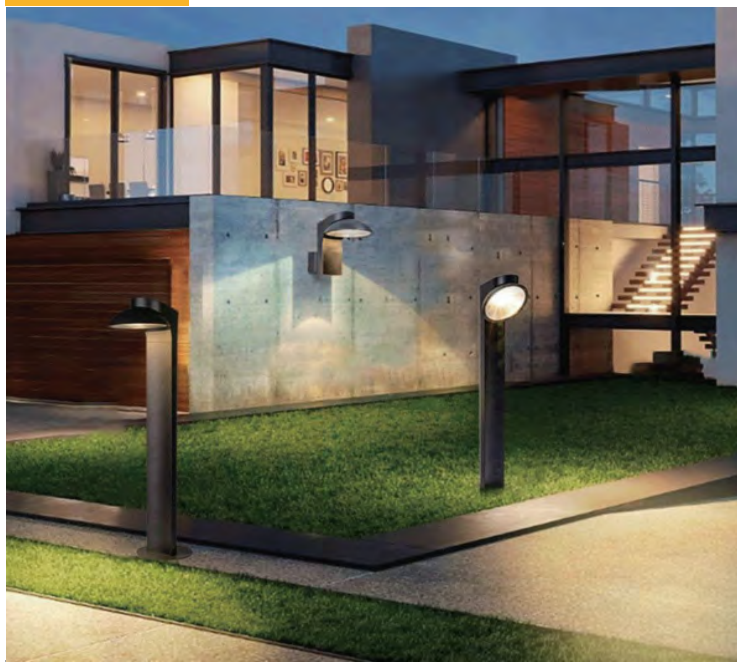

## Balizadores Jardim



Potência	<b>6W</b>
Kelvins	<b>3000K</b>
Lumens	<b>480lm</b>
Voltagem	175-240V
Material	<b>Die-Cast Aluminium + Glass</b>
CRI	<b>&gt;80</b>
Índice de Protecção	IP54
Led	COB
Côr	<b>Cinzeno Escuro</b>
Certificado	CE, RoHS,ErP

Referencia	Potencia	Lumens	Temp. Cor	CRI	Dimensões	Preço
<b>GOMA230</b>	<b>6W</b>	480	3000K	80	135X210X230mm	<b>29,45 €</b>



Potência	<b>6W</b>
Kelvins	<b>3000K</b>
Lumens	<b>480lm</b>
Voltagem	175-240V
Material	<b>Die-Cast Aluminium + Glass</b>
CRI	<b>&gt;80</b>
Índice de Protecção	IP54
Led	COB
Côr	<b>Cinzeno Escuro</b>
Certificado	CE, RoHS,ErP

Referencia	Potencia	Lumens	Temp. Cor	CRI	Dimensões	Preço
<b>GOMA500</b>	<b>6W</b>	480	3000K	80	135X210X500mm	<b>42,65 €</b>
<b>GOMA800</b>	<b>6W</b>	480	3000K	80	135X210X800mm	<b>45,74 €</b>



## Luz Solar com Sensor Inteligente



Painel Solar	5,5V/1,2W / Monocrystalline Silicon	Quantidade de Led's	96 pcs
Tipo Bateria	3.7V/2200mAh Li-ion Battery(include)	Índice de Protecção	IP65
Material	ABS + PS Plastic	Tempo de Carga	8H
Certificado	CE, RoHS	Tempo de Funcionamento	10H (Após carregamento completo)

Referencia	Temp. Cor	Preço
GLS-FLAME	1800K	14,99 €

## Luz Solar com Sensor Inteligente



Painel Solar	5,5V/2W / Monocrystalline Silicon
Tipo Bateria	3.2V/1500mAh Li-ion Battery(include)
Material:	ABS+PC
Certificado	CE, RoHS
Quantidade de Led's	10 pcs
Índice de Protecção	IP65
Sensor delay time:	30-35s
Sensor distance:	5-7mt
Índice de Protecção	IP65

Ninguém na área do Sensor (2-6mt): A luz irá acender apenas a 5%  
 Alguém na área do Sensor (2-6mt): A luz irá acender a 100%

Referencia	Temp. Cor	Dimensão	Preço
SL/2W-4	4000K	100X138X69mm	13,04 €

## Luz Solar com Sensor Inteligente



Painel Solar	5,5V/2W / Monocrystalline Silicon
Tipo Bateria	3.2V/1500mAh Li-ion Battery(include)
Material:	ABS+PC
Certificado	CE, RoHS
Quantidade de Led's	10 pcs
Índice de Protecção	IP65
Sensor delay time:	30-35s
Sensor distance:	5-7mt
Índice de Protecção	IP65

Ninguém na área do Sensor (2-6mt): A luz irá acender apenas a 5%  
 Alguém na área do Sensor (2-6mt): A luz irá acender a 100%

Referencia	Temp. Cor	Dimensão	Preço
SL/3W-4	4000K	100X138X69mm	15,17 €

## Luz Solar com Sensor Inteligente



Painel Solar	5,5V/6,5W / Monocrystalline Silicon
Tipo Bateria	3.7V/2200mAh Li-ion Battery(include)
Material	ABS + PS Plastic
Certificado	CE, RoHS
Quantidade de Led's	138 pcs SMD2835
Índice de Protecção	IP65
Tempo de Carga	8H
Tempo de Funcionamento	2H (Após carregamento completo)

Referencia	Temp. Cor	Dimensões	Preço
SL/1004	6000K	355x35x110mm	24,71 €

## Luz Solar com Sensor Inteligente



Painel Solar	6V/3,6W / Monocrystalline Silicon
Tipo Bateria	3.7V/2200mAh Li-ion Battery(include)
Material	ABS + PS Plastic
Certificado	CE, RoHS
Quantidade de Led's	12x2pcs SMD2835
Índice de Protecção	IP65
Tempo de Carga	6H
Tempo de Funcionamento	2H (Após carregamento completo)

Acende automaticamente à noite (10-40Lux)

Referencia	Temp. Cor	Dimensões	Preço
SL/3001	6000K	126x176x720	29,84 €

## Luz Solar com Sensor Inteligente



Painel Solar	5,5V/2W / Monocrystalline Silicon
Tipo Bateria	3.7V/2200mAh Li-ion Battery(include)
Material	ABS + PS Plastic
Certificado	CE, RoHS
Quantidade de Led's	138 pcs SMD2835
Índice de Protecção	IP65
Tempo de Carga	8H
Tempo de Funcionamento	2H (Após carregamento completo)

Referencia	Temp. Cor	Dimensões	Preço
SL/3024	6000K	118x85x155mm	16,11 €

## Projektor Solar



Ângulo Abertura	90
Classe de Protecção	Class I
Material	Puro Alumínio / Lentes em PC
Certificado	TUV, CE, RoHS, ErP, IEC

CRI	>80
Índice de Protecção	IP65
Índice de Impacto	IK 08
Factor Potência	>0,9

Referencia	Potencia	Lumens	Temp. Cor	Solar	Bateria	Dimensão	Led SMD	Preço
SL-50W-6	50W	1350	6000K	12W/5V	DC3,2V/10Ah	180x210x42mm	2835-36	38,13 €
SL-100W-6	100W	2000		18W/5V	DC3,2V/15Ah	225x255x42mm	2835-66	52,52 €

## Projektor Solar

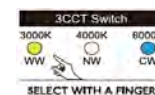

Ângulo Abertura	90
Classe de Protecção	Class III
Material	Puro Alumínio / Lentes em PC
Certificado	TUV, CE, RoHS, ErP, IEC

CRI	>80
Índice de Protecção	IP65
Índice de Impacto	IK 08
Factor Potência	>0,9

Referencia	Potencia	Lumens	Temp. Cor	Solar	Bateria	Dimensão	Led SMD	Preço
SL-100W-CCT	100W	3600	CCT	20W/6V	DC3,2V/15Ah	255x185x43,6mm	2835	62,59 €
SL-400W-CCT	400W	7200		40W/6V	DC3,2V/30Ah	409x301x43,6mm	2835	139,54 €

## Luz Solar com Sensor Inteligente



Painel Solar	5,5V/1,8W / Monocrystalline Silicon
Tipo Bateria	3.7V/4000mAh Li-ion Battery(include)
Material	Alu + Anti-Glare PC Diffuser
Certificado	CE, RoHS
Sensor	Microwave Sensor
Indice de Protecção	IP54
Tempo Carga	6 ~ 8H
Tempo de Funcionamento	12 ~ 15H

Referencia	Potencia	Lumens	Temp. Cor	CRI	Dimensões	Preço
SL-8001-60	3W	200	3000K	80	118x132x600mm	60,00 €
SL-8001-80					118x132x800mm	62,97 €

## Luz Solar com Sensor Inteligente



Painel Solar	5,5V/1,8W / Monocrystalline Silicon
Tipo Bateria	3.7V/4000mAh Li-ion Battery(include)
Material	Alu + Anti-Glare PC Diffuser
Certificado	CE, RoHS
Sensor	Microwave Sensor
Indice de Protecção	IP54
Tempo Carga	6 ~ 8H
Tempo de Funcionamento	12 ~ 15H

Referencia	Potencia	Lumens	Temp. Cor	CRI	Dimensões	Preço
SL-8001-W	3W	200	3000K	80	118x135x241mm	43,97 €

## Luz Solar Ambiente



Painel Solar	5,5V/2W / Monocrystalline Silicon
Tipo Bateria	3.7V/4x1200mAh Li-ion Battery(include)
Material	ABS + Plastic
Certificado	CE, RoHS
Quantidade de Led's	18 pcs SMD2835
Indice de Protecção	IP65
Tempo de Carga	Solar - 14 ~ 16H / Type C - 8 ~ 9H
Tempo de Funcionamento	25% 39 ~ 40H
	50% 15 ~ 17H
	100% 3 ~ 4H

Referencia	Potencia	Lumens	Temp. Cor	CRI	Dimensões	Preço
SL-2102	3W	330	3000K	80	135x135x82mm	36,23 €
SL-2104						

# 21 Steplights



WALL/R1-P

WALL/S1-P



WALL/615-3

WALL/R2-B

WALL/S3-B

Referencia	Potencia	Lumens	Temp. Cor	Voltagem	Corte	Dimensão	Cor
WALL/615-3	3W	180	3000K	175 - 265VAC	Ø59mm		Preto
WALL/S1-B							Branco
WALL/S1-P						85x85x57mm	Preto
WALL/S3-B							Branco
WALL/S3-P							Preto
WALL/R1-B							Branco
WALL/R1-P						Ø85x59mm	Preto
WALL/R2-B							Branco
WALL/R2-P							Preto

## Steps HP

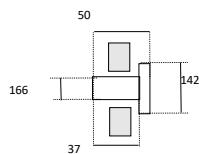

Obs: Inclui molas de fixação

## Especificações técnicas:

Material:	Alumínio/Branco
Cobertura	Transparente
Tipo de Led:	Epistar HP
Quant. Leds:	1
Tipo drive:	Externo



Referencia	Potencia	Lumens	Temp. Cor	Voltagem	Corte	Dimensão	Preço
646/W	3W	200	6000K	85 - 265VAC	166x54mm	142X60mm	16,88 €
646/WW		180	3000K				

## Steps HP

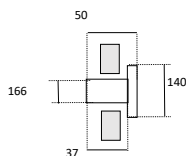

Obs: Inclui molas de fixação

## Especificações técnicas:

Material:	Alumínio/Branco
Cobertura	Transparente
Tipo de Led:	Epistar HP
Quant. Leds:	1
Tipo drive:	Externo



Referencia	Potencia	Lumens	Temp. Cor	Voltagem	Corte	Dimensão	Preço
647/W	3W	200	6000K	85 - 265VAC	166x53mm	142x61mm	18,00 €
647/WW		180	3000K				

## Steps HP

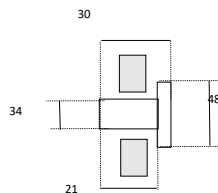

## Especificações técnicas:

Material:	Alumínio/Branco
Cobertura	Transparente
Tipo de Led:	Epistar HP
Quant. Leds:	1
Tipo drive:	Externo



Referencia	Potencia	Lumens	Temp. Cor	Voltagem	Corte	Dimensão	Preço
649/W	3W	200	6000K	85 - 265VAC	Ø34mm	Ø48mm	8,26 €
649/WW		180	3000K				

## Steps HP

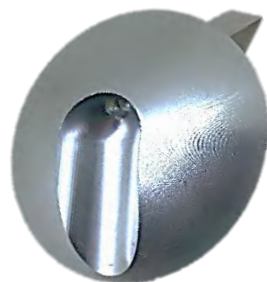
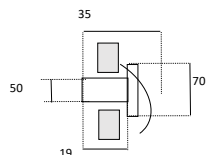

Obs: Inclui molas de fixação

## Especificações técnicas:

Material:	Alumínio/Escovado
Cobertura	Não
Tipo de Led:	Epistar HP
Quant. Leds:	1
Tipo drive:	Externo



Referencia	Potencia	Lumens	Temp. Cor	Voltagem	Corte	Dimensão	Preço
650/W	3W	100	6000K	85 - 265VAC	Ø50mm	Ø70mm	12,38 €
650/WW		85	3000K				

## Steps HP

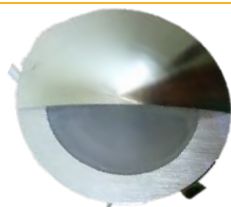
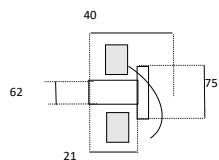
Especificações técnicas:

Material: Alumínio/Escovado  
 Cobertura: Opalina  
 Tipo de Led: Epistar HP  
 Quant. Leds: 1  
 Tipo drive: Externo

90°



IP

40

FP

0,95

CRI

&gt;80

Referencia	Potencia	Lumens	Temp. Cor	Voltagem	Corte	Dimensão	Preço
653/W	3W	300	6000K	85 - 265VAC	Ø64mm	Ø74mm	17,94 €
653/WW		270	3000K				

## Steps HP

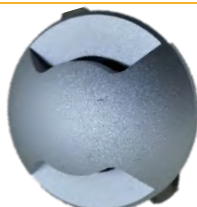
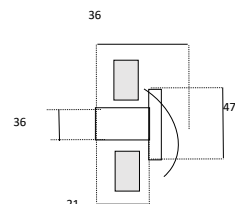
Especificações técnicas:

Material: Alumínio/Escovado  
 Cobertura: Opalino Lateral  
 Tipo de Led: Epistar HP  
 Quant. Leds: 1  
 Tipo drive: Externo

Indireto



IP

40

FP

0,95

CRI

&gt;80

Referencia	Potencia	Lumens	Temp. Cor	Voltagem	Corte	Dimensão	Preço
654/W	3W	300	6000K	85 - 265VAC	Ø36mm	Ø47mm	11,21 €
654/WW		270	3000K				

## Steps HP

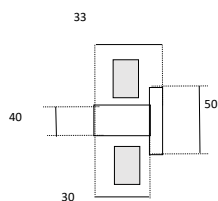
Especificações técnicas:

Material: Alumínio/Lac. Branco  
 Cobertura: Opalino  
 Tipo de Led: Epistar HP  
 Quant. Leds: 1  
 Tipo drive: Externo

Indireto



IP

40

FP

0,95

CRI

&gt;80

Referencia	Potencia	Lumens	Temp. Cor	Voltagem	Corte	Dimensão	Preço
655/W	3W	300	6000K	85 - 265VAC	65x40mm	80x50mm	19,60 €
655/WW		270	3000K				

## Steps HP

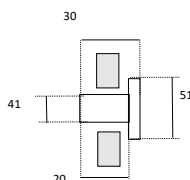
Especificações técnicas:

Material: Alumínio/Escovado  
 Cobertura: Não  
 Tipo de Led: Epistar HP  
 Quant. Leds: 1  
 Tipo drive: Externo

90°



IP

40

FP

0,95

CRI

&gt;80

Referencia	Potencia	Lumens	Temp. Cor	Voltagem	Corte	Dimensão	Preço
656/W	1W	100	6000K	85 - 265VAC	Ø41mm	Ø51mm	8,78 €
656/WW		85	3000K				

## Steps HP

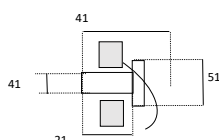
Especificações técnicas:

Material: Alumínio/Escovado  
 Cobertura: Não  
 Tipo de Led: Epistar HP  
 Quant. Leds: 1  
 Tipo drive: Externo

Indireto



IP

40

FP

0,95

CRI

&gt;80

Referencia	Potencia	Lumens	Temp. Cor	Voltagem	Corte	Dimensão	Preço
657/W	2W	200	6000K	85 - 265VAC	Ø41mm	Ø51mm	10,15 €
657/WW		180	3000K				

## Steps HP

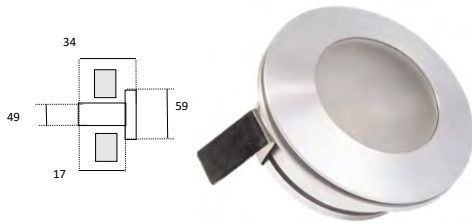

## Especificações técnicas:

Material:	Alumínio/Escovado
Cobertura:	Opalina
Tipo de Led:	Epistar HP
Quant. Leds:	1
Tipo drive:	Externo

Obs: Ideal p/ aplicar no exterior

Referencia	Potencia	Lumens	Temp. Cor	Voltagem	Corte	Dimensão	Preço
659/W	3W	250	6000K	85 - 265VAC	Ø49mm	Ø59mm	14,97 €



## Steps 3CCT IP66



WALL/120B-CCT

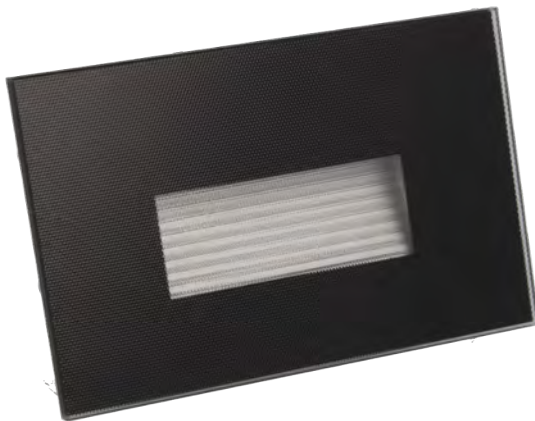
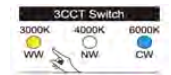

Mudança

WALL/38P-CCT



Obs: Ideal p/ aplicar no exterior. de temperatura de cor no interior.



Referencia	Potencia	Lumens	Temp. Cor	Voltagem	Corte	Dimensão	Cor	Preço
WALL/120P-CCT	5W	450	3 - CCT	175 - 265VAC	87,5x53x55mm	105x81x50mm	Preto	17,84 €
WALL/120B-CCT							Branco	
WALL/38P-CCT							Preto	
WALL/38B-CCT							Branco	18,39 €

## Caixa de Encastre

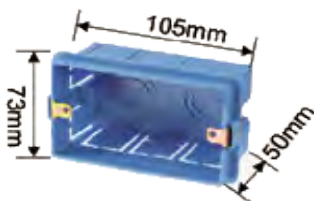

Referencia	Dimensão	Cor	Preço
WALL/BOX	105x73x50mm	Azul	0,89 €



## Steps Modulares IP54



Standard EU



Base: WALL/615-3



WALL/R2



WALL/S1

Potência	3W
Kelvins	3000K
Lumens	200lm
Voltagem	175-265V
Material	Die-Cast Aluminium + PC
CRI	>80
Índice de Protecção	IP54
Dimensões	Ø59
Certificado	CE, RoHS,ErP,SELV

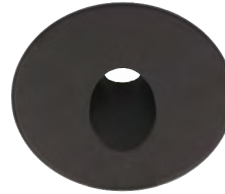

WALL/R1

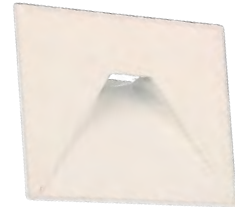

WALL/S3

Referencia	Potência	Lumens	Temp. Cor	Voltagem	Corte	Dimensão	Cor	Preço
WALL/615-3	3W	180	3000K	175 - 265VAC	Ø59mm		Preto	9,96 €
Referencia							Cor	Preço
WALL/S1-B							Branco	
WALL/S1-P							Preto	
WALL/S3-B							Branco	
WALL/S3-P							Preto	
WALL/R1-B							Branco	3,36 €
WALL/R1-P							Preto	
WALL/R2-B							Branco	
WALL/R2-P							Preto	

## Steps Modulares IP54



Standard EU



Base: WALL/A815



WALL/S1S



WALL/S3S

Potência	1,5W
Kelvins	3000K
Lumens	100lm
Voltagem	175-265V
Material	Die-Cast Aluminium + PC
CRI	>80
Índice de Protecção	IP44
Dimensões	Ø59
Certificado	CE, RoHS,ErP,SELV



WALL/S6S

Referencia	Potência	Lumens	Temp. Cor	Voltagem	Corte	Dimensão	Cor	Preço
WALL/815	1,5W	100	CCT	175 - 265VAC	Ø59mm		Preto	10,23 €
Referencia		Referencia		Referencia			Cor	Preço
WALL/S1S-B							Branco	
WALL/S1S-P							Preto	
WALL/S3S-B							Branco	
WALL/S3S-P							Preto	
WALL/S6S-B							Branco	3,58 €
WALL/S6S-P							Preto	

# 22 Paineis de Encastrar

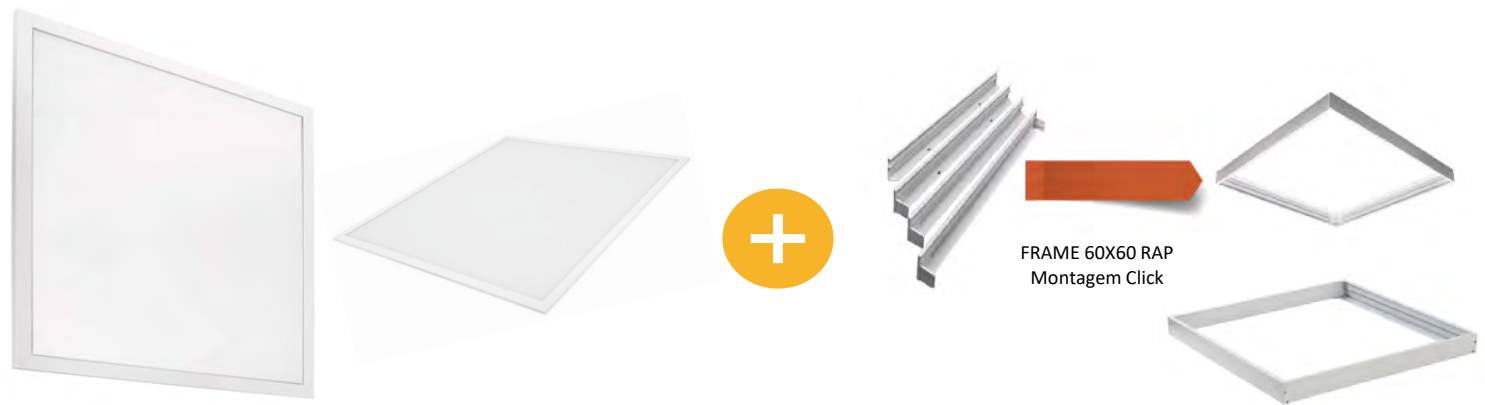

Referencia	Potencia	Lumens	Temp. Cor	Voltagem	Corte	Dimensão	Led SMD
089/40PMMA-4 C/A	40W	5000	4000K	200 - 250VAC	595x595mm	620x620mm	4014-204
089/40PMMA-6 C/A			6000K				
089/40PMMA-4			4000K				
089/40PMMA-6			6000K				
<b>FRAME 60X60 RAP</b>	Branco Mate				595X595mm	630X630X50mm	

## Painel de Led Redondo Encastrar 3W /4W /6W /9W /12W /15W /18W /20W /24W



120°



IP

40

FP

0,5

CRI

&gt;80

Obs: As dimensões são meramente indicativas, sujeitas a confirmação.

Potência	Referencia / Branco	Preço	Referencia / Nickel	Preço	Temp. Cor	Lumens	Voltagem	Corte	Dimensão	Led SMD
4W			086/4WAE	3,28 €	6000K	300	165- 265VAC	Ø95mm	Ø105x11mm	2835-20
			086/4PWAE		4000K	290				
			086/4WWAE		3000K	280				
9W			086/9WAE	4,76 €	6000K	630	165- 265VAC	Ø125mm	Ø145x11mm	2835-45
			086/9WWAE		3000K	610				
12W			086/12WWAE	5,14 €	3000K	860	165- 265VAC	Ø149mm	Ø169x11mm	2835-60
15W			086/15WWAE	5,06 €	3000K	1020	165- 265VAC	Ø170mm	Ø190x11mm	2835-75
20W	086/20W 086/20PW 086/20WW	6,88 €	086/20WAE	9,45 €	6000K	1500	165- 265VAC	Ø220mm	Ø240x11mm	2835-100
			086/20PWAE		4000K	1450				
			086/20WWAE		3000K	1400				
24W			086/24PWAE	12,64 €	4000K	1850	165- 265VAC	Ø275mm	Ø297x11mm	2835-120
			086/24WWAE		3000K	1800				

## Painel de Led Quadrado Encastrar 6W / 9W / 15W / 18W / 24W

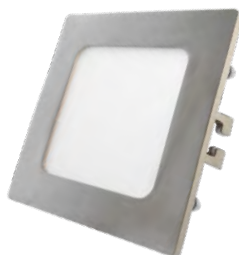
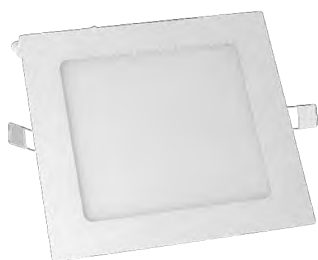

120°



IP

40

FP

0,5

CRI

&gt;80

Obs: As dimensões são meramente indicativas, sujeitas a confirmação.

Potência	Referencia / Branco	Preço	Referencia / Nickel	Preço	Temp. Cor	Lumens	Voltagem	Corte	Dimensão	Led SMD
6W			084/6WWAE	3,82 €	3000K	430	200 - 250VAC	100x100mm	120x120mm	2835-30
9W	084/9W 084/9WW	3,60 €			6000K	630	200 - 250VAC	130x130mm	145x145mm	2835-45
					3000K	610				
15W	084/WWM	4,50 €	084/15WWAE	5,52 €	3000K	1050	200 - 250VAC	178x178mm	200x200mm	2835-75
18W	084/18-4 084/18-3	5,18 €			4000K	1350	200 - 250VAC	200x200mm	225x225mm	2835-100
					3000K	1300				
24W	083/WWM	8,20 €	083/WAE	11,00 €	6000K	1780	200 - 250VAC	270x270mm	292x292mm	2835-120
			083/PWAE		4000K	1750				
			083/WWAE		3000K	1700				

## Painel de Led Redondo Encastrar 5W /6W /9W /12W /15W /18W /24W LGP

NOVO



- Painéis com difusor LGP e sem pontos de fuga de Luz

120°

IP 40

FP 0,5

CRI &gt;80

Obs: As dimensões são meramente indicativas, sujeitas a confirmação.

Potência	Referencia / Branco	Preço	Referencia / Nickel	Preço	Temp. Cor	Lumens	Voltagem	Corte	Dimensão	Led SMD
5W	086/5LGP-6	3,65 €	086/5LGPN-6	4,18 €	6000K	425	100 - 265VAC	Ø70mm	Ø83x11mm	2835-25
	086/5LGP-4		086/5LGPN-4		4000K	410				
	086/5LGP-3		086/5LGPN-3		3000K	400				
6W	086/6LGP-6	3,82 €	086/6LGPN-6	5,00 €	6000K	550	100 - 265VAC	Ø105mm	Ø120x11mm	2835-30
	086/6LGP-4		086/6LGPN-4		4000K	530				
	086/6LGP-3		086/6LGPN-3		3000K	520				
9W	086/9LGP-6	4,53 €	086/9LGPN-6	6,05 €	6000K	765	100 - 265VAC	Ø130mm	Ø150x11mm	2835-45
	086/9LGP-4		086/9LGPN-4		4000K	750				
	086/9LGP-3		086/9LGPN-3		3000K	750				
12W	086/12LGP-6	4,74 €	086/12LGPN-6	6,85 €	6000K	1020	100 - 265VAC	Ø155mm	Ø170x11mm	2835-60
	086/12LGP-4		086/12LGPN-4		4000K	1005				
	086/12LGP-3		086/12LGPN-3		3000K	1000				
15W	086/15LGP-6	6,04 €	086/15LGPN-6	10,10 €	6000K	1275	100 - 265VAC	Ø170mm	Ø190x11mm	2835-75
	086/15LGP-4		086/15LGPN-4		4000K	1260				
	086/15LGP-3		086/15LGPN-3		3000K	1260				
18W	086/18LGP-6	6,57 €	086/18LGPN-6	11,85 €	6000K	1530	100 - 265VAC	Ø205mm	Ø225x11mm	2835-90
	086/18LGP-4		086/18LGPN-4		4000K	1515				
	086/18LGP-3		086/18LGPN-3		3000K	1000				
24W	086/24LGP-6	11,37 €	086/24LGPN-6	15,22 €	6000K	2040	100 - 265VAC	Ø280mm	Ø305x11mm	2835-120
	086/24LGP-4		086/24LGPN-4		4000K	2025				
	086/24LGP-3		086/24LGPN-3		3000K	2015				

## Painel de Led Quadrado Encastrar 5W / 9W / 15W / 18W / 24W LGP

NOVO



- Painéis com difusor LGP e sem pontos de fuga de Luz

120°

IP 40

FP 0,5

CRI &gt;80

Obs: As dimensões são meramente indicativas, sujeitas a confirmação.

Potência	Referencia / Branco	Preço	Referencia / Nickel	Preço	Temp. Cor	Lumens	Voltagem	Corte	Dimensão	Led SMD
5W	083/5LGP-6	3,63 €	083/5LGPN-6	3,83 €	6000K	425	100 - 265VAC	75x75mm	90x90mm	2835-25
	083/5LGP-4		083/5LGPN-4		4000K	410				
	083/5LGP-3		083/5LGPN-3		3000K	400				
6W	083/6LGP-6	3,82 €	083/6LGPN-6	4,69 €	6000K	450	200 - 250VAC	105x105mm	120x120mm	2835-30
	083/6LGP-4		083/6LGPN-4		4000K	440				
	083/6LGP-3		083/6LGPN-3		3000K	430				
9W	083/9LGP-6	5,38 €	083/9LGPN-6	5,66 €	6000K	760	100 - 265VAC	130x130mm	150x150mm	2835-45
	083/9LGP-4		083/9LGPN-4		4000K	750				
	083/9LGP-3		083/9LGPN-3		3000K	740				
15W	083/15LGP-6	6,27 €	083/15LGPN-6	8,54 €	6000K	1275	100 - 265VAC	170x170mm	195x195mm	2835-75
	083/15LGP-4		083/15LGPN-4		4000K	1260				
	083/15LGP-3		083/15LGPN-3		3000K	1250				
18W	083/18LGP-6	7,05 €	083/18LGPN-6	9,57 €	6000K	1530	100 - 265VAC	205x205mm	225x225mm	2835-100
	083/18LGP-4		083/18LGPN-4		4000K	1515				
	083/18LGP-3		083/18LGPN-3		3000K	1505				
24W	083/24LGP-6	10,32 €	083/24LGPN-6	10,83 €	6000K	2040	100 - 265VAC	280x280mm	305x305mm	2835-120
	083/24LGP-4		083/24LGPN-4		4000K	2025				
	083/24LGP-3		083/24LGPN-3		3000K	1505				

## Painel de Led Redondo Encastrar IP44 6W / 12W / 18W / 24W IP44



### Especificações técnicas:

Material/Acabamento:	Lac. Branco Mate
Cobertura	Opalina
Tipo drive:	Externo (Inc)



Obs: As dimensões são meramente indicativas, sujeitas a confirmação.

Referencia	Potencia	Lumens	Temp. Cor	Voltagem	Corte	Dimensão	Led SMD	Preço
086/R6-6 086/R6-3	6W	450 440	6000K 3000K	165- 265VAC	Ø75mm	Ø90x9mm	2835-30	3,90 €
086/R12-6 086/R12-3	12W	1000 950	6000K 3000K	165- 265VAC	Ø125mm	Ø145x9mm	2835-60	6,00 €
086/R18-6 086/R18-3	18W	1650 1600	6000K 3000K	165- 265VAC	Ø155mm	Ø175x9mm	2835-90	7,80 €

## Painel de Encastrar Redondo Com Drive Interno IP44



### Especificações técnicas:

Material/Acabamento:	Lac. Branco Mate
Cobertura	Opalina
Tipo drive:	Interno



Obs: As dimensões são meramente indicativas, sujeitas a confirmação.

Referencia	Potencia	Lumens	Temp. Cor	Voltagem	Corte	Dimensão	Led SMD	Preço
086/18PW DI	18W	1620	4000K	85-265VAC	Ø155mm	Ø175x10mm	2835-90	8,59 €

## Panel de Led Quadrado Hi-Performance 60X60 PMMA



### Especificações técnicas:

Material/Acabamento:

Tempo de vida:

Cobertura

Tipo drive:

Lac. Branco Mate

30.000H Led

Opalina

Externo (Inc) Boke

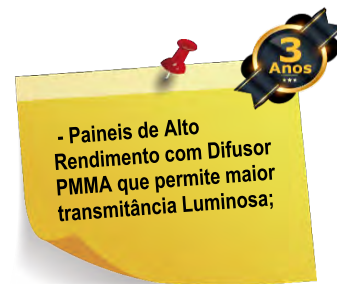

Obs: Designação C/A - Com abas para encastrar. As dimensões são meramente indicativas, sujeitas a confirmação.

Ângulo Abertura	120
Classe de Protecção	Class II
Material	Aluminium / Difusor PMMA
Certificado	TUV SUD, CE, RoHS, SAA, SELV

CRI	80
Índice de Protecção	IP44
Índice de Impacto	IK 04
Factor Potência	>0,9



Referencia	Potencia	Lumens	Temp. Cor	Voltagem	Corte	Dimensão	Led SMD	Preço
089/40PMMA-4 C/A	40W	5000	4000K	200 - 250VAC	595x595mm	620x620mm	4014-204	43,76 €
089/40PMMA-6 C/A			6000K					
089/40PMMA-4			4000K					
089/40PMMA-6			6000K					

## Painel de Led Retangular Hi-Performance 120x30 PMMA



### Especificações técnicas:

Material/Acabamento:

Tempo de vida:

Cobertura

Tipo drive:

Lac. Branco Mate

30.000H Led

Opalina

Externo (Inc) Boke



Obs: Designação C/A - Com abas para encastrar. As dimensões são meramente indicativas, sujeitas a confirmação.

Ângulo Abertura	120
Classe de Protecção	Class II
Material	Aluminium / Difusor PMMA
Certificado	TUV SUD, CE, RoHS, SAA, SELV

CRI	80
Índice de Protecção	IP44
Índice de Impacto	IK 04
Factor Potência	>0,9



Referencia	Potencia	Lumens	Temp. Cor	Voltagem	Corte	Dimensão	Led SMD	Preço
090/40PMMA-4 C/A	40W	5000	4000K	200 - 250VAC	1195x295mm	1220x320mm	4014-240	45,29 €
090/40PMMA-4			1195x295mm					
090/40PMMA-6 C/A			1220x320mm					
090/40PMMA-6			1195x295mm					

## Panel de Led Quadrado 60X60 40W / 48W



## Especificações técnicas:

Material/Acabamento:	Lac. Branco Mate
Cobertura	Opalina
Tipo drive:	Externo (Inc)

Obs: Designação C/A - Com abas para encastrar. As dimensões são meramente indicativas, sujeitas a confirmação.



Referencia	Potencia	Lumens	Temp. Cor	Voltagem	Corte	Dimensão	Led SMD	Preço
089/ECO86 C/A	40W	3200	6000K	200 - 250VAC	575x575mm	595x595mm		24,60 €
089/48EQ86	48W	3600	6000K	200 - 250VAC		595x595mm		27,00 €
089/24-30x30-W	24W	2200	6000K	200 - 250VAC		295x295mm		14,07 €

## Panel de Led Retangular Encastrar



## Especificações técnicas:

Material/Acabamento:	Lac. Branco Mate
Cobertura	Opalina
Tipo drive:	Externo (Inc)



Obs: Painel com abas para encastrar. As dimensões são meramente indicativas, sujeitas a confirmação.



Referencia	Potencia	Lumens	Temp. Cor	Voltagem	Corte	Dimensão	Led SMD	Preço
090/24PMMA-4	24W	2400	4000K	200 - 250VAC		295x595mm	2835-120	32,30 €
090/24PMMA-4 C/A					295x595mm	320x620mm		

## Aro para painel 60X60 / 120X30 (frame)

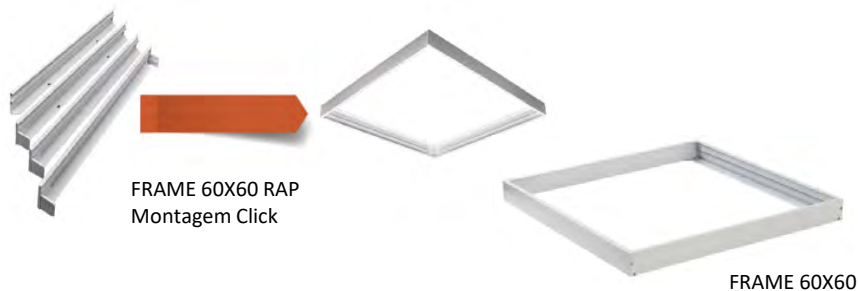

FRAME 60X60 RAP  
Montagem Click

FRAME 60X60

Obs: Ideal para aplicação exterior de painel. As dimensões são meramente indicativas, sujeitas a confirmação.

Referencia	Cor	Material	Voltagem	Corte	Dimensão	Led SMD	Preço
FRAME 60X30 RAP				595X295mm	630x330x50mm		6,85 €
FRAME 60X60 RAP				595X595mm	630x630x50mm		8,47 €
FRAME 120X30 RAP				1195X295mm	1230x330x50mm		11,37 €
FRAME 120X30AL	Aluminio						11,40 €

# 23 Painéis de Superfície



Referencia	Potencia	Lumens	Temp. Cor	Voltagem	Base	Dimensão	Preço
089/48W 60RS	48W	4280	4000K	85- 265VAC	Redondo	600x40mm	2835-240
089/32W 40RS	32W	2880	4000K	85- 265VAC	Redondo	400x40mm	2835-240



## Painel de Superfície Redondo 6W / 12W / 18W / 24W



### Especificações técnicas:

Material/Acabamento: Alumínio/Lac. Branco Mate  
 Cobertura Opalina  
 Tipo drive: Externo (Inc)



Referencia	Potencia	Lumens	Temp. Cor	Voltagem	Base	Dimensão	Led SMD	Preço
661/12LGP-6	12W	880	6000K	200 - 250VAC	Redondo	Ø175x38mm	2835-60	5,84 €
661/12LGP-4		870	4000K					
661/12S83		860	3000K					
662/18LGP-6	18W	1400	6000K	200 - 250VAC	Redondo	Ø225x38mm	2835-90	8,42 €
662/18LGP-4		1350	4000K					
662/18S83		1300	3000K					
663/24LGP-6	24W	1800	6000K	200 - 250VAC	Redondo	Ø300x38mm	2835-120	12,20 €
663/24LGP-4		1750	4000K					
663/24S83		1700	3000K					

## Painel de Superfície Redondo 6W / 12W / 18W / 24W IP44



### Especificações técnicas:

Material/Acabamento: Lac. Branco Mate  
 Cobertura Opalina  
 Tipo drive: Externo (Inc)



Referencia	Potencia	Lumens	Temp. Cor	Voltagem	Base	Dimensão	Led SMD	Preço
086/RS6-6	6W	450	6000K	165- 265VAC	Redondo	Ø90x35mm	2835-30	6,17 €
086/RS6-3		440	3000K					
086/RS12-6	12W	1000	6000K	165- 265VAC	Redondo	Ø145x35mm	2835-60	8,37 €
086/RS12-3		950	3000K					
086/RS18-6	18W	1650	6000K	165- 265VAC	Redondo	Ø180x35mm	2835-90	11,55 €
086/RS18-3		1600	3000K					
086/RS24-6	24W	2100	6000K	165- 265VAC	Redondo	Ø230x35mm	2835-120	14,40 €
086/RS24-3		2050	3000K					

## Painel de Superfície Quadrado 6W / 12W / 18W / 24W



### Especificações técnicas:

Material/Acabamento: Alumínio/Lac. Branco Mate  
 Cobertura Opalina  
 Tipo drive: Externo (Inc)



Referencia	Potencia	Lumens	Temp. Cor	Voltagem	Base	Dimensão	Led SMD	Preço
666/6SQ86	6W	450	6000K	200 - 250VAC	Quadrado	120x120x38mm	2835-30	4,01 €
666/6SQ84		440	4000K					
666/6SQ83		430	3000K					
664/12R86	12W	880	6000K	200 - 250VAC	Quadrado	175x175x38mm	2835-60	6,19 €
664/12SQLGP-4		870	4000K					
664/12R83		860	3000K					
665/18SQLGP-6	18W	1400	6000K	200 - 250VAC	Quadrado	225x225x38mm	2835-90	8,73 €
665/18SQLGP-4		1350	4000K					
665/18SQ83		1300	3000K					
667/24SQLGP-6	24W	1800	6000K	200 - 250VAC	Quadrado	300x300x38mm	2835-120	12,69 €
667/24SQLGP-4		1750	4000K					
667/24SQ83		1700	3000K					

## Painel de Superfície Redondo/Quadrado



### Especificações técnicas:

Material/Acabamento: Lac. Branco Mate  
 Tempo de vida: 30.000H Led  
 Cobertura: Opalina  
 Tipo drive: Externo (Inc)

120°  
  
 IP 40  
 FP 0,80  
 CRI >80

Referencia	Potencia	Lumens	Temp. Cor	Voltagem	Base	Dimensão	Led SMD	Preço
662/18PWRS	18W	1680	4000K	165- 265VAC	Redondo	180X55mm	2835-90	12,25 €
665/18PWSQ	18W	1680	4000K	165- 265VAC	Quadrado	180X180X55mm	2835-90	12,70 €

## Painel de Superfície Redondo



### Especificações técnicas:

Material/Acabamento: Lac. Branco Mate  
 Tempo de vida: 30.000H Led  
 Cobertura: Opalina  
 Tipo de Led: SMD 2835  
 Quant. Leds: 240  
 Tipo drive: Externo (Inc)

120°  
  
 IP 40  
 FP 0,80  
 CRI >80

Referencia	Potencia	Lumens	Temp. Cor	Voltagem	Base	Dimensão	Preço	Preço
089/48W 60RS	48W	4280	4000K	85- 265VAC	Redondo	600X40mm	2835-240	49,00 €
089/32W 40RS	32W	2880	4000K	85- 265VAC	Redondo	400x40mm	2835-240	30,15 €

## Painel Redondo de Superfície/Suspenso



120°  
  
 IP 40  
 FP 0,80  
 CRI >80

Referencia	Potencia	Lumens	Temp. Cor	Voltagem	Base	Dimensão	Preço	Preço
089/50-CCT	50W	5000	3CCT	185- 265VAC	Redondo	600X27mm	2835-240	52,00 €
Kit de suspensão						089/KIT50		2,65 €
089/32-CCT	32W	3200	3CCT	185- 265VAC	Redondo	400x25mm	2835-240	33,00 €
Kit de suspensão						089/KIT32		2,16 €

# 24 Painéis Customizados - CCT e Ajustáveis

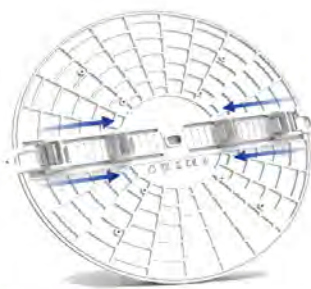

**FRAMELESS DESIGN**  
**01 ADJUSTABLE**  
Fit cut-out from 70-205mm



**ADJUSTABLE**  
Fit cut-out from 70-205mm

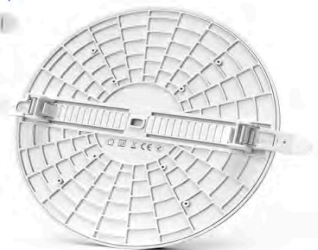
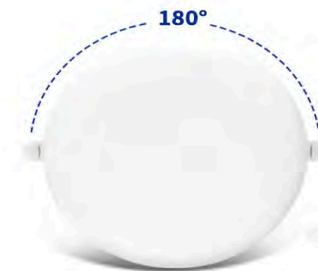

**FRAMELESS DESIGN**  
**02 BEAM ANGLE**  
Beam angle up to 180°

Referencia	Potencia	Lumens	Temp. Cor	Voltagem	Corte	Dimensão	Led SMD
KE-6-4	6W	600	4000K	85-265VAC	Ø75mm	Ø90x27mm	2835
KE-9-4	9W	900	4000K	85-265VAC	Ø75mm	Ø90x27mm	2835
KE-12-4	12W	1200	4000K	85-265VAC	Ø70-100mm	Ø120x27mm	2835
KE-18-4	18W	1800	4000K	85-265VAC	Ø70-100mm	Ø120x27mm	2835
KE-24-4	24W	2400	4000K	85-265VAC	Ø70-150mm	Ø170x27mm	2835
KE-36-4	36W	3600	4000K	85-265VAC	Ø70-205mm	Ø225x27mm	2835

## Painel de Superfície e Encastrar CCT de 18W + Sensor Micro-Wave



### Especificações técnicas:

Material/Acabamento:  
Tempo de vida:  
Cobertura  
Tipo de Led:  
Tempo de Estabilização

Lac. Branco Mate  
30.000H Led  
Opalina  
Alto Brilho  
35 Segundos

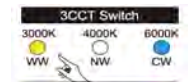

Referencia	Potencia	Lumens	Temp. Cor	Voltagem	Corte	Dimensão	Led SMD	Preço
086/18CCT3-S	18W	1530	3000K+4000K+6000K	85-265VAC	Ø65-180mm	Ø225x20mm	2835-90	19,66 €

## Painel de Encastrar Com Sensor IR 18W



### Especificações técnicas:

Material/Acabamento:  
Tempo de vida:  
Cobertura  
Tipo de Led:  
Tempo de Estabilização

Lac. Branco Mate  
30.000H Led  
Opalina  
Alto Brilho  
35 Segundos



Referencia	Potencia	Lumens	Temp. Cor	Voltagem	Corte	Dimensão	Led SMD	Preço
086/18PWSEN	18W	1680	4000K	85-265V	Ø55-200mm	225x30mm	2835-90	13,82 €

## Painel de Superfície Com Sensor PIR 18W



### Especificações técnicas:

Material/Acabamento:  
Tempo de vida:  
Cobertura  
Tipo drive:  
Tempo de sensor  
Raio de ação

Lac. Branco Mate  
30.000H Led  
Opalina  
Externo (Incluído)  
30s/120s/off  
6 mt



Referencia	Potencia	Lumens	Temp. Cor	Voltagem	Dimensão	Led SMD	Preço
PL-3CCT18W-PIR	18W	1800	3000K+4000K+6000K	175-265VAC	217*23mm	2835-180	19,66 €

## Painel Ajustável 6W / 15W / 20W



### Especificações técnicas:

Material/Acabamento:	Alumínio/Lac. Branco Mate
Tempo de vida:	30.000H Led
Cobertura:	Opalina
Tipo drive:	Interno

120°



IP

40

FP

0,80

CRI

&gt;80

Referencia	Potencia	Lumens	Temp. Cor	Voltagem	Corte	Dimensão	Led SMD	Preço
086/6W-28REG	6W	460	2800K	100-240VAC	Ø20-100mm	Ø100x20mm	2835-30	2,51 €
086/9W-4REG	9W	720	4000K	100-240VAC	Ø20-100mm	Ø118x20mm	2835-60	3,25 €
086/15W-28REG	15W	1180	2800K	100-240VAC	Ø40-155mm	Ø175x20mm	2835-90	4,31 €
086/15W-4REG	15W	1200	4000K	100-240VAC	Ø40-155mm	Ø175x20mm	2835-90	4,31 €
086/20W-28REG	20W	1580	2800K	100-240VAC	Ø60-200mm	Ø228x20mm	2835-120	6,27 €
086/20W-4REG	20W	1600	4000K	100-240VAC	Ø60-200mm	Ø228x20mm	2835-120	6,27 €

## Painel de Encastrar CCT de 18W



### Especificações técnicas:

Material/Acabamento:	Lac. Branco Mate
Tempo de vida:	30.000H Led
Cobertura:	Opalina
Tipo de Led:	SMD2835
Quant. Leds:	90
Tipo drive:	Externo (Inc)

120°



IP

40

FP

0,80

CRI

&gt;80

Obs: Painel que permite alteração da temperatura de cor 3000K/4000K/6000K no interruptor

Referencia	Potencia	Lumens	Temp. Cor	Voltagem	Base	Corte	Dimensão	Preço
086/18-3C	18W	1680	3000K+4000K+6000K	85-265VAC	Redondo	205mm	220X10mm	10,79 €

## Painel Ajustável 6W / 9W / 12W / 18W / 24W / 36W

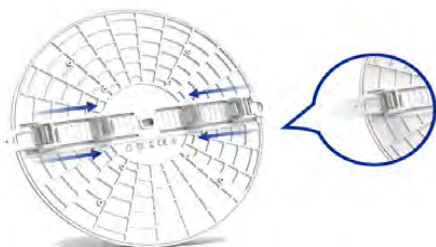

FRAMELESS DESIGN

01 ADJUSTABLE

Fit cut-out from 70-205mm

ADJUSTABLE

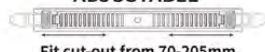

Fit cut-out from 70-205mm

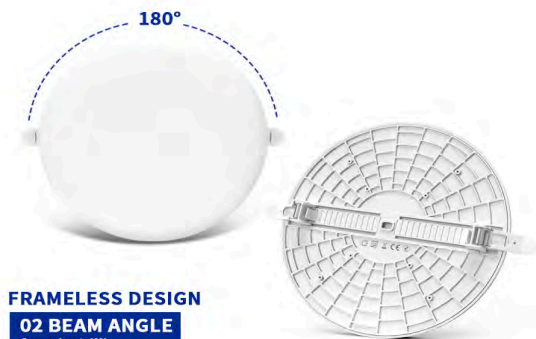

FRAMELESS DESIGN

02 BEAM ANGLE

Beam angle up to 180°



FP

0,90

CRI

&gt;80

Referencia	Potencia	Lumens	Temp. Cor	Voltagem	Corte	Dimensão	Led SMD	Preço
KE-6-4	6W	600	4000K	85-265VAC	Ø75mm	Ø90x27mm	2835	3,58 €
KE-9-4	9W	900	4000K	85-265VAC	Ø75mm	Ø90x27mm	2835	3,98 €
KE-12-4	12W	1200	4000K	85-265VAC	Ø70-100mm	Ø120x27mm	2835	5,25 €
KE-18-4	18W	1800	4000K	85-265VAC	Ø70-100mm	Ø120x27mm	2835	6,88 €
KE-24-4	24W	2400	4000K	85-265VAC	Ø70-150mm	Ø170x27mm	2835	9,01 €
KE-36-4	36W	3600	4000K	85-265VAC	Ø70-205mm	Ø225x27mm	2835	12,99 €

# 25 HAY BAYS

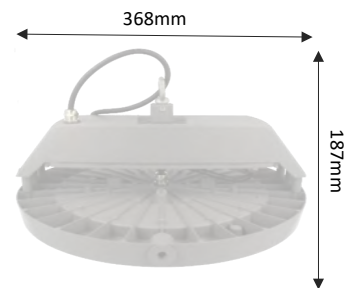

Referencia	Potencia	Lumens	Temp. Cor	Voltagem	Fixação	Dimensão	Led SMD
HAY/BAY 100N	100 W	13 000				Ø368x187mm	3030-133
HAY/BAY 150N	150 W	19 500	5000K	90 - 305VAC	Aste/Suspensão	Ø368x187mm	3030-210
HAY/BAY 200N	200 W	26 000				Ø423x187mm	3030-315

## Hay/Bay



PHILIPS

Ângulo Abertura	90
Classe de Protecção	Class I
Material	Pure Aluminium
Certificado	Dekra, TUV, CE, RoHS, ErP, SGS, SAA

CRI	80
Índice de Protecção	IP65
Índice de Impacto	IK 08
Factor Potência	>0,9

Referencia	Potencia	Lumens	Temp. Cor	Voltagem	Fixação	Dimensão	Led SMD	Preço
HAY/BAY 100N	100 W	13 000				Ø368x187mm	3030-133	125,32 €
HAY/BAY 150N	150 W	19 500	5000K	90 - 305VAC	Aste/Suspensão	Ø368x187mm	3030-210	161,48 €
HAY/BAY 200N	200 W	26 000				Ø423x187mm	3030-315	191,16 €

## Hay/Bay DIMAVEL 0-10V 240W



PHILIPS

Ângulo Abertura	90
Classe de Protecção	Class I
Material	Pure Aluminium
Certificado	TUV, CE, RoHS, ErP, SAA

CRI	80
Índice de Protecção	IP65
Índice de Impacto	IK 09
Factor Potência	>0,9

Referencia	Potencia	Lumens	Temp. Cor	Voltagem	Fixação	Dimensão	Led SMD	Preço
HAY/BAY 240D	240 W	28 800	5000K	100-240VAC	Aste/Suspensão	Ø260x160mm	2835-140	148,14 €

**Hay/Bay 100W / 150W / 200W**



Ângulo Abertura	<b>90</b>
Classe de Protecção	<b>Class I</b>
Material	<b>Pure Aluminium</b>
Certificado	<b>TUV, CE, RoHS, ErP, SAA</b>

CRI	<b>80</b>
Índice de Protecção	<b>IP65</b>
Índice de Impacto	<b>IK 09</b>
Factor Potência	<b>&gt;0,9</b>

Referencia	Potencia	Lumens	Temp. Cor	Voltagem	Fixação	Dimensão	Led SMD	Preço
HAY/BAY 100P	100 W	15 000				Ø260x160mm	2835-140	60,89 €
HAY/BAY 150P	150 W	22 500	5700K	180 - 305VAC	Aste/Suspensão	Ø310x160mm	2835-210	81,19 €
HAY/BAY 200P	200 W	30 000				Ø350x180mm	2835-280	107,55 €

**Hay/Bay DriverLess**

Ângulo Abertura	<b>120</b>
Classe de Protecção	<b>Class I</b>
Material	<b>Pure Aluminium</b>
Certificado	<b>Dekra, TUV, CE, RoHS, ErP, SGS, SAA</b>

CRI	<b>80</b>
Índice de Protecção	<b>IP65</b>
Índice de Impacto	<b>IK 08</b>
Factor Potência	<b>&gt;0,9</b>

Referencia	Potencia	Lumens	Temp. Cor	Voltagem	Fixação	Dimensão	Led SMD	Preço
HAY/BAY 100ECO	100 W	10 000	5000K	200 - 265VAC	Aste/Suspensão	Ø280x95mm	2835-133	47,67 €
HAY/BAY 200ECO	200 W	20 000				Ø400x100mm	2835-315	90,85 €



## Hay/Bay DriverLess



PHILIPS

Ângulo Abertura	90
Classe de Protecção	Class I
Material	Pure Aluminium
Certificado	TUV, CE, RoHS, ErP, SAA

CRI	80
Índice de Protecção	IP65
Índice de Impacto	IK 09
Factor Potência	>0,9

Referencia	Potencia	Lumens	Temp. Cor	Voltagem	Fixação	Dimensão	Led SMD	Preço
HAY/BAY 150L	150 W	22 500	5000K	100 - 265VAC	Aste/Suspensão	Ø320x80mm	2835-210	57,08 €

## Suportes p/ Hay/Bay

Referencia	Preço
------------	-------



SUP/HBAY 150/200W  
SUP/HBAY 100W

Suportes p/ Hay Bay de 150W e 200W  
Suportes p/ Hay Bay de 100W

10,62 €

# 26 Lâmpadas Industriais



Referencia	Potencia	Lumens	Temp. Cor	Voltagem	Base	Dimensão	Led SMD
072/WW			3000K				
072/840	60W	6 100	4000K	175 - 265VAC	E40	Ø120x265mm	2835
072			6000K				

## Corns Industriais ED90



Referencia	Potencia	Lumens	Temp. Cor	Voltagem	Base	Dimensão	Led SMD	Preço
CORN/30W-6	30W	3 000	6000K	175 - 265VAC	E27	Ø90x218mm	2835	12,28 €
CORN/50W-6	50W	5 000				Ø90x218mm	2835	18,47 €

## Corns Industriais ED120



Referencia	Potencia	Lumens	Temp. Cor	Voltagem	Base	Dimensão	Led SMD	Preço
072/WW			3000K					
072/840	60W	6 100	4000K	175 - 265VAC	E40	Ø120x265mm	2835	22,83 €
072			6000K					

# 27 Fita de Led 12V



Referencia	Potencia	Led SMD	Lumens/Mt.	Temp. Cor	Voltagem	IP	Size	Cut
246/860	13W/mt	2835-120	1 350	6000K	12VDC	20	10mm	5cm
246/840			1 350	4000K				
246/830			1 350	3000K				
247/860	13W/ Mt.	2835-120	1 550	6000K	12VDC	65	10mm	5cm
247/840			1 450	4000K				
247/830			1 350	3000K				

## Fita Led 12V 4,8W/Mt. (Premium)



Obs.: A nossa fita de 12V/24V é vendida em rolos de 5 metros

Referencia	Potencia	Led SMD	Lumens/Mt.	Temp. Cor	Voltagem	IP	Size	Cut	Preço/mt
256	4,8W/mt	3528-60	300	6000K	12VDC	20	8mm	10cm	2,71 €
255/827		2835-64	300	2700K					
256/860	4,8W/mt	2835-64	300	6000K	12VDC	65	8mm	10cm	3,61 €
256/827		2835-64	300	2700K					
285/S		3528-60	300	Vermelho					
287/S		3528-60	300	Azul					



## Fita Led 12V 5,76W/Mt. (Premium)

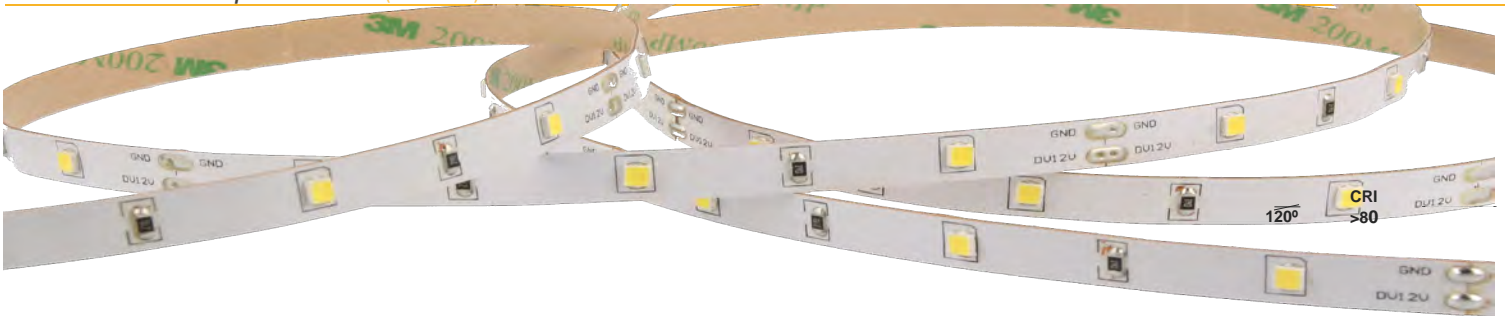

Obs.: A nossa fita de 12V/24V é vendida em rolos de 5 metros

Referencia	Potencia	Led SMD	Lumens/Mt.	Temp. Cor	Voltagem	IP	Size	Cut	Preço/mt
239/12-6	5,76W/mt	2835-30	490	6000K	12VDC	20	8mm	10cm	2,03 €
239/12-28		2835-30	440	2800K					
239/12-6S	5,76W/mt	2835-30	490	6000K	12VDC	65	8mm	10cm	3,39 €



## Fita Led 12V 7W/Mt. (Premium)



Obs.: A nossa fita de 12V/24V é vendida em rolos de 5 metros

Referencia	Led SMD	Led SMD	Lumens/Mt.	Temp. Cor	Voltagem	IP	Size	Cut	Preço/mt
235/12-6S	7W/mt	2216-60	700	6000K	12VDC	65	8mm	5cm	4,47 €



## Fita Led 12V 7,2W/Mt. (Premium)



Obs.: A nossa fita de 12V/24V é vendida em rolos de 5 metros

Referência	Potencia	Led SMD	Lumens/Mt.	Temp. Cor	Voltagem	IP	Size	Cut	Preço/mt
293 257+	7,2W/mt	5050-30	600	6000K	12VDC	20	10mm	10cm	2,89 €
265+/S 270/S 288/S	7,2W/mt	5050-30	500 (3cores) 600 600	R G B 6000K Vermelho	12VDC	65	10mm	10cm	4,24 €
298 298/WW 297	7,2W/mt	5050-30	600 600 550 (3cores)	6000K 3000K R G B	12VDC	68	10mm	10cm	6,28 €

## Fita Led 12V 8W/Mt. (Premium)



Obs.: A nossa fita de 12V/24V é vendida em rolos de 5 metros

Referência	Potencia	Led SMD	Lumens/Mt.	Temp. Cor	Voltagem	IP	Size	Cut	Preço/mt
240/W 240/840 240/828	8W/mt 7,2W/mt 7,2W/mt	5630-30 2835-80 2835-80	900 1 080 1 000	6000K 4000K 2800K	12VDC	20	10mm	10cm	3,61 €
241/W 241/840 241/WW 241/828	8W/mt 7,2W/mt 8W/mt 7,2W/mt	5630-30 2835-80 5630-30 2835-80	900 1 080 800 1 000	6000K 4000K 3000K 2800K	12VDC	65	10mm	10cm	4,97 €

## Fita Led 12V 12W/Mt. 3D (Premium)



Obs.: Fita ideal p/ angulos retos devido ao seu formato permite fazer curvas e angulos de 90°, assim como contornar uma circunferência.

Referência	Potencia	Referência	Lumens/Mt.	Temp. Cor	Voltagem	IP	Size	Cut	Preço/mt
244/3DPW	12W/mt	2835-60	1 250	4000K	12VDC	20	8mm	5cm	4,52 €

## Fita Led 12V 12W/Mt. (Premium)



Obs.: A nossa fita de 12V/24V é vendida em rolos de 5 metros

Referencia	Potencia	Led SMD	Lumens/Mt.	Temp. Cor	Voltagem	IP	Size	Cut	Preço/mt
244/W	12W/mt	2835-60	1 250	6000K	12VDC	20	10mm	5cm	2,89 €
244/840			1 250	4000K					
244/WW			1 250	3000K					
244/824			1 250	2400K					
245/W	12W/mt	2835-60	1 250	6000K	12VDC	65	10mm	5cm	4,24 €
245/840			1 250	4000K					
245/WW			1 250	3000K					
245/824			1 250	2400K					

## Fita Led 12V 13W/Mt. (Premium)



Obs.: A nossa fita de 12V/24V é vendida em rolos de 5 metros

Referencia	Potencia	Led SMD	Lumens/Mt.	Temp. Cor	Voltagem	IP	Size	Cut	Preço/mt
246/860	13W/mt	2835-120	1 350	6000K	12VDC	20	10mm	5cm	4,16 €
246/840			1 350	4000K					
246/830			1 350	3000K					
247/860	13W/ Mt.	2835-120	1 550	6000K	12VDC	65	10mm	5cm	5,46 €
247/840			1 450	4000K					
247/830			1 350	3000K					



## Fita Led 12V 14,4W/Mt. (Premium)



Obs.: A nossa fita de 12V/24V é vendida em rolos de 5 metros

Referencia	Polencia	Led SMD	Lumens/Mt.	Temp. Cor	Voltagem	IP	Size	Cut	Preço/mt
299/SN			1000(3cores)	<b>R</b> <b>G</b> <b>B</b>	12VDC	20	10mm	5cm	4,52 €
273/S4			1 150	4000K					
276/S			1000(3cores)	<b>R</b> <b>G</b> <b>B</b>					
282/R	14,4W/mt	5050-60	900	Vermelho	12VDC	65	10mm	5cm	6,32 €
262/B			900	Azul					
262/Y			900	Amarelo					
296			1 150	6000K					
296/WW	14,4W/mt	5050-60	1 150	3000K	12VDC	68	10mm	5cm	7,68 €

## Fita Led 12V 14,4W/Mt. CRI≥90 (Premium)



Obs.: A nossa fita de 12V/24V é vendida em rolos de 5 metros

Referencia	Polencia	Led SMD	Lumens/Mt.	Temp. Cor	Voltagem	IP	Size	Cut	Preço/mt
232/PW	14,4W/mt	2216-180	1 300	4000K	12VDC	20	10mm	3cm	7,90 €





## Fita Led 12V 18W/Mt. (Premium)



Obs.: A nossa fita de 12V/24V é vendida em rolos de 5 metros

Referencia	Potencia	Led SMD	Lumens/Mt.	Temp. Cor	Voltagem	IP	Size	Cut	Preço/mt
243/840	18W/mt	5630-60	1 800	4000K	12VDC	65	10mm	5cm	7,23 €
243/WW			1 700	3000K					



## Fita Led 12V 18W/Mt RGB+W (Premium)

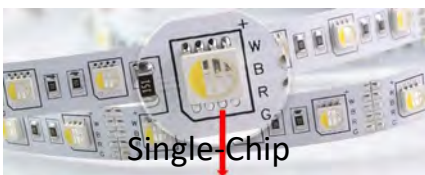
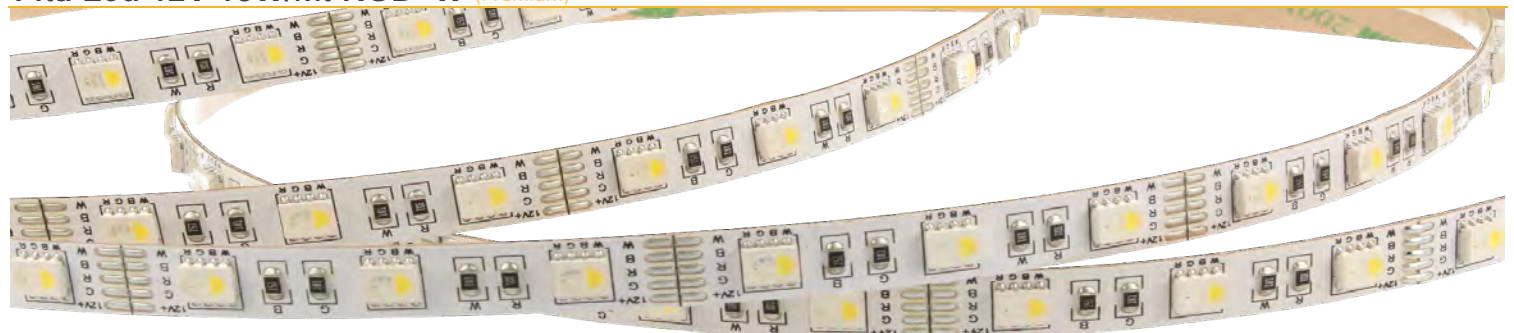

Obs.: A nossa fita de 12V/24V é vendida em rolos de 5 metros

Referencia	Potencia	Led SMD	Lumens/Mt.	Temp. Cor	Voltagem	IP	Size	Cut	Preço/mt
313	18W/mt	5050-60	1250 (6000K)	R G B + 6000K	12VDC	20	10mm	5cm	8,31 €
314			1050 (3000K)	R G B + 3000K					



## Fita Led 12V 19,2W/Mt. (Premium)



Obs.: A nossa fita de 12V/24V é vendida em rolos de 5 metros

Referencia	Potencia	Led SMD	Lumens/Mt.	Temp. Cor	Voltagem	IP	Size	Cut	Preço/mt
242N/860	19,2W/mt	2835-160	2 496	6000K	12VDC	20	10mm	5cm	6,77 €
242N/840			2 400	4000K					
242N/830			2 326	3000K					
243N/860	19,2W/ Mt.	2835-160	2 496	6000K	12VDC	65	10mm	5cm	7,56 €
243N/840			2 400	4000K					
243N/830			2 326	3000K					



## Fita Led 12V 22W/Mt. (Premium)

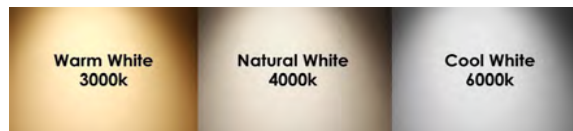

Obs.: A nossa fita de 12V/24V é vendida em rolos de 5 metros

Referencia	Led SMD	Led SMD	Lumens/Mt.	Temp. Cor	Voltagem	IP	Size	Cut	Preço/mt
232/CCT	22W/mt	2216-240	2 100	6000K+3000K	12VDC	20	10mm	5cm	9,87 €

## Fita Led 12V 4,8W/Mt. (Standard)



### Especificações técnicas:

PCB/Cor: Branco  
Tempo de vida: 30.000H Led



Obs.: A nossa fita de 12V/24V é vendida em rolos de 5 metros

Referencia	Potencia	Led SMD	Lumens/Mt.	Temp. Cor	Voltagem	Corte	Size	Cut	Preço/mt
256/C	4,8W/ Mt.	3528-60	300	6000K	12VDC	20	8mm	5cm	1,40 €
267/RS	4.8W/ Mt.	3528-60	300	3000K	12VDC	65	8mm	5cm	1,80 €
266/RS			300	6000K	12VDC	65			

## Fita Led 12V 7,2W/Mt. (Standard)



### Especificações técnicas:

PCB/Cor: Branco  
Tempo de vida: 30.000H Led



Obs.: A nossa fita de 12V/24V é vendida em rolos de 5 metros

Referencia	Potencia	Led SMD	Lumens/Mt.	Temp. Cor	Voltagem	IP	Size	Cut	Preço/mt
270/RS	7,2W/ Mt.	5050-30	450	6000K	12VDC	65	10mm	10cm	2,50 €
271/RS			450	3000K	12VDC	65			

## Fita Led 12V 12W/Mt. (Standard)



### Especificações técnicas:

PCB/Cor: Branco  
Tempo de vida: 30.000H Led



Obs.: A nossa fita de 12V/24V é vendida em rolos de 5 metros

Referencia	Potencia	Led SMD	Lumens/Mt.	Temp. Cor	Voltagem	IP	Size	Cut	Preço/mt
245/840RS	12W/ Mt.	2835-60	1 250	4000K	12VDC	65	10mm	5cm	1,96 €
245/WWRS			1 250	3000K	12VDC	65			

# 28 Fita de Led 24V



Referencia	Potencia	Led SMD	Lumens/Mt.	Temp. Cor	Voltagem	IP	Size	Cut
501/860-24			1 300	6000K				
501/840-24	14,4W/ Mt.	280	1 150	4000K	24VDC	67	10mm	2,5cm
501/827-24			1 150	2700K				

## Fita Led 24V 4,8W/Mt. (Premium)

- As Fitas da Gama Premium de 12/24V podem estar ligadas 24 horas consecutivas, oferecendo uma garantia total de funcionamento.



Obs.: A nossa fita de 12V/24V é vendida em rolos de 5 metros

Referencia	Potencia	Led SMD	Lumens/Mt.	Temp. Cor	Voltagem	IP	Size	Cut	Preço/mt
255/860-24			720	6000K					
255/840-24	4,8W	2835-64	696	4000K	24VDC	20	8mm	10cm	2,86 €
255/827-24			672	2700K					
255/824-24			660	2400K					
256/860-24			720	6000K					
256/840-24	4,8W	2835-64	696	4000K	24VDC	65	8mm	10cm	3,61 €
256/827-24			672	2700K					

## Fita Led 24V 7,2W/Mt. (Premium)

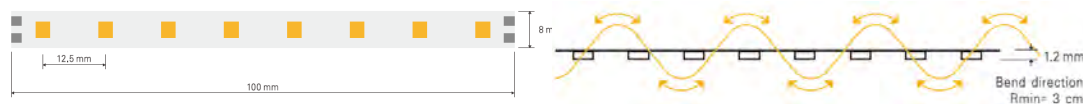

Obs.: A nossa fita de 12V/24V é vendida em rolos de 5 metros

Referencia	Potencia	Led SMD	Lumens/Mt.	Temp. Cor	Voltagem	IP	Size	Cut	Preço/mt
240/860-24			1 152	6000K					
240/840-24	7,2W	2835-80	1 129	4000K	24VDC	20	8mm	10cm	3,61 €
240/828-24			1 002	2700K					
241/860-24			1 152	6000K					
241/840-24	7,2W	2835-80	1 129	4000K	24VDC	65	8mm	10cm	4,97 €
241/828-24			1 002	2700K					

## Fita Led 24V 8,64W/Mt. (Premium)



Obs.: A nossa fita de 12V/24V é vendida em rolos de 5 metros

Referencia	Potencia	Led SMD	Lumens/Mt.	Temp. Cor	Voltagem	IP	Size	Cut	Preço/mt
233/24-6			800	6000K					
233/24-4	8,64W/ Mt.	2216-210	770	4000K	24VDC	20	5mm	5cm	7,04 €
233/24-3			790	2800K					

## Fita Led COB 24V 10W/Mt. (Premium)



Obs.: A nossa fita de 12V/24V é vendida em rolos de 5 metros

Referencia	Potencia	Led	Lumens/Mt.	Temp. Cor	Voltagem	IP	Size	Cut	Preço/mt				
500/COB-6 500/COB-4 500/COB-3	10W/ Mt.	512 Led/Mt.	1 005 987 896	6000K 4000K 2700K	24VDC	20	8mm	6,25cm	4,31 €				
500/COB-R 500/COB-B 500/COB-Y	11W/ Mt.	480 Led/Mt.	900 900 900	Vermelho Azul Amarelo									
500/COB-RGB	11W/ Mt.	864 Led/Mt.		R G B									
500/COB-4S 500/COB-3S	10W/ Mt.	480 Led/Mt.	987 896	4000K 2700K						66	10mm	6,25cm	10,84 € 6,09 €

## Fita Led COB 24V 11W/Mt. (Rolo 50Mt.) (Premium)



Rolos de 50mt Fita vendida ao metro

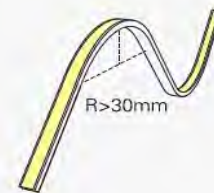
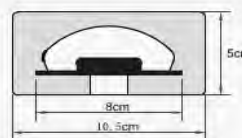

Referencia	Potencia	Led	Lumens/Mt.	Temp. Cor	Voltagem	IP	Size	Cut	Preço/mt
500/COB11-4M 500/COB11-3M	11W/ Mt.	480 Led/Mt.	805 785	4000K 2700K	24VDC	66	10mm	5cm	5,84 €
248/50RGB-24	12,5W/ Mt.	3838-60		R G B					7,81 €

## Fita Led 24V 150LM/W 11,52W/Mt. (Premium)

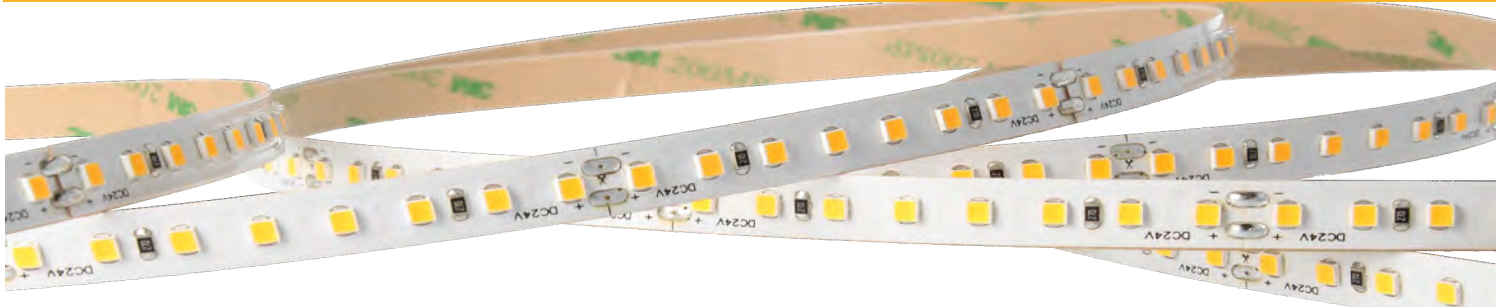

Obs.: A nossa fita de 12V/24V é vendida em rolos de 5 metros

Referencia	Potencia	Led SMD	Lumens/Mt.	Temp. Cor	Voltagem	IP	Size	Cut	Preço/mt
238/24-6 238/24-4	11,52W/Mt.	2835-128	1 728 1 628	6000K 4000K	24VDC	20	10mm	6cm	5,91 €
237/24-6S 237/24-4S	11,52W/Mt.	2835-128	1 728 1 628	6000K 4000K	24VDC	65	10mm	6cm	7,27 €

## Fita Led 24V 12W/Mt. (Premium)



Obs.: A nossa fita de 12V/24V é vendida em rolos de 5 metros.

referência 248/860-24 e 248/827-24 é vendida em rolos de 10metros

A



Referencia	Potencia	Led SMD	Lumens/Mt.	Temp. Cor	Voltagem	IP	Size	Cut	Preço/mt
244/W24			1 350	6000K					
244/24-840	12W/ Mt.	2835-60	1 250	4000K	24VDC	20	10mm	10cm	2,89 €
244/W24			1 150	3000K					
244/24-824			1 150	2489K					
244/RGB24			1 150	R G B					
245/W24			1 350	6000K					
245/840-24	12W/ Mt.	2835-60	1 250	4000K	24VDC	65	10mm	10cm	4,24 €
245/824-24			1 150	2900K					
248/860-24			1 350	6000K					
248/827-24	12W/ Mt.	2835-60	1 150	2700K	24VDC	68	10mm	10cm	7,59 €
248/RGB-24			1 150	R G B					

## Fita Led 24V 13W/Mt. (Premium)

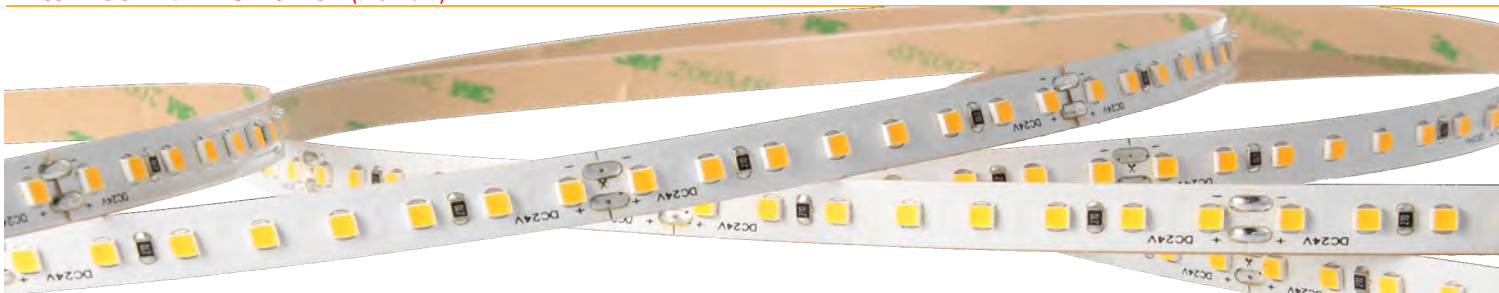

Obs.: A nossa fita de 12V/24V é vendida em rolos de 5 metros



Referencia	Potencia	Led SMD	Lumens/Mt.	Temp. Cor	Voltagem	IP	Size	Cut	Preço/mt
246/860-24			1 550	6000K					
246/840-24	13W/ Mt.	2835-120	1 450	4000K	24VDC	20	10mm	5cm	4,16 €
246/830-24			1 350	3000K					
246/RGB-24			1 350	R G B					
247/860-24			1 550	6000K					
247/840-24	13W/ Mt.	2835-120	1 450	4000K	24VDC	65	10mm	5cm	5,46 €
247/830-24			1 350	3000K					
247/RGB-24			1 350	R G B					

## Fita Led 24V 14,4W/Mt. (Premium)

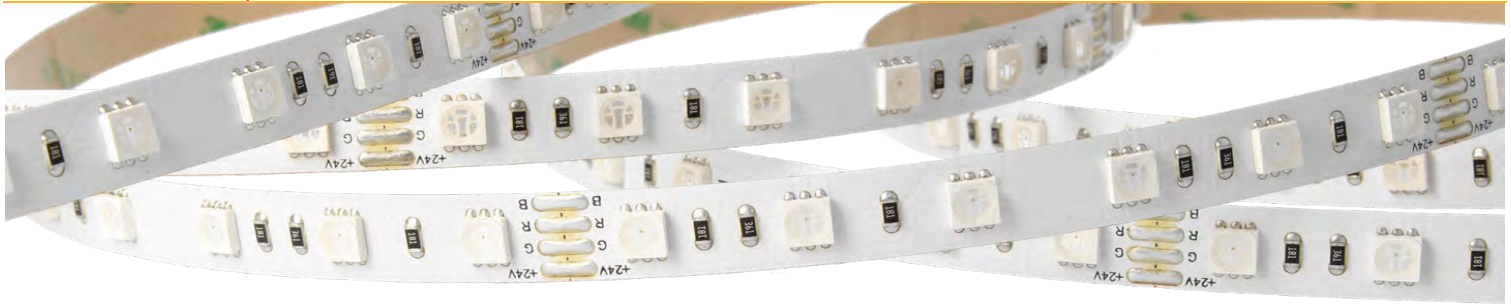

Obs.: A nossa fita de 12V/24V é vendida em rolos de 5 metros

Referencia	Potencia	Led SMD	Lumens/Mt.	Temp. Cor	Voltagem	IP	Size	Cut	Preço/mt
292/RGB24	14,4W/ Mt.	5050-60		R G B	24VDC	20	10mm	5cm	4,52 €
299/RGB24	14,4W/ Mt.	5050-60		R G B	24VDC	65	10mm	5cm	5,87 €

## Fita Led 24V 15W/Mt. (Premium)

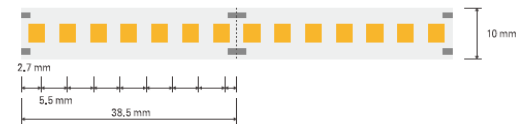

Obs.: A nossa fita de 12V/24V é vendida em rolos de 5 metros

Referencia	Potencia	Led SMD	Lumens/Mt.	Temp. Cor	Voltagem	IP	Size	Cut	Preço/mt
249/860-24			1 847	6000K					
249/840-24			1 840	4000K					
249/830-24	15W/Mt.	2835-182	1 840	3000K	24VDC	20	10mm	3,8cm	4,70 €
249/827-24			1 755	2700K					
249/823-24			1 587	2300K					
250/840-24			1 840	4000K					
250/830-24	15W/Mt.	2835-182	1 787	3000K	24VDC	65	10mm	3,8cm	6,05 €
250/827-24			1 755	2700K					

## Fita Led COB 24V 16W/Mt. (Premium)

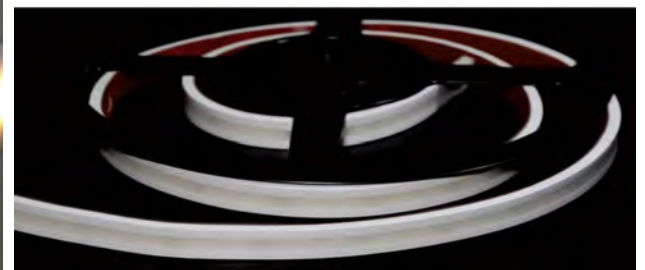

Obs.: A nossa fita de 12V/24V é vendida em rolos de 5 metros

Referencia	Potencia	Led	Lumens/Mt.	Temp. Cor	Voltagem	IP	Size	Cut	Preço/mt
500/COB16-4			1 300	4000K					
500/COB16-27	16W/ Mt.	480 Led/Mt.	1 150	2700K	24VDC	20	10mm	5cm	5,53 €
500/COB16-23			1 150	2300K					
501/860-24	14,4W/ Mt.		1 300	6000K					
501/840-24	16W/ Mt.	280	1 150	4000K	24VDC	67	10mm	5cm	9,89 €
501/827-24	16W/ Mt.		1 150	2643K					

Fita Led 24V 18W/Mt. (Premium)



Single-Chip



Referencia	Potencia	Led SMD	Lumens/Mt.	Temp. Cor	Voltagem	IP	Size	Cut	Preço/mt
315/24	18W/ Mt.	5050-60	1 300	RGB + 3000K+4000K+6000K			12mm	10cm	11,29 €
313/24		5050-60	1 250	RGB +6000K	24VDC	20	12mm	10cm	8,31 €
293/RGB-24	18,4W/ Mt.	5050-96	1 250	RGB			10mm	5cm	7,50 €

Fita Led 24V 19,2W/Mt. (Premium)

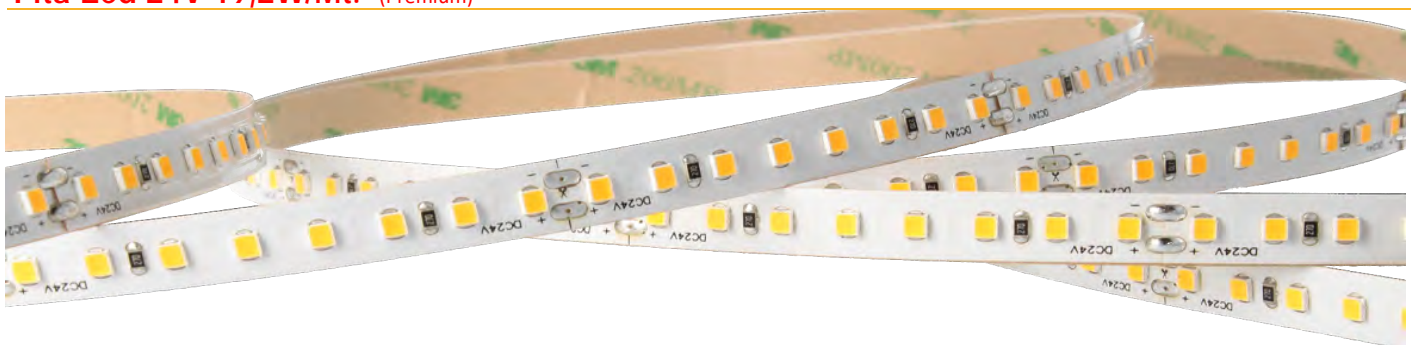

Obs.: A nossa fita de 12V/24V é vendida em rolos de 5 metros

Referencia	Potencia	Led SMD	Lumens/Mt.	Temp. Cor	Voltagem	IP	Size	Cut	Preço/mt
242N/860-24			2 496	6000K					
242N/840-24	19,2W/ Mt.	2835-160	2 400	4000K	24VDC	20	10mm	5cm	6,77 €
242N/830-24			2 326	3000K					
243N/860-24			2 496	6000K					
243N/840-24	19,2W/ Mt.	2835-160	2 400	4000K	24VDC	65	10mm	5cm	7,56 €
243N/830-24			2 326	3000K					

Fita Led 24V 22W/Mt. (Premium)

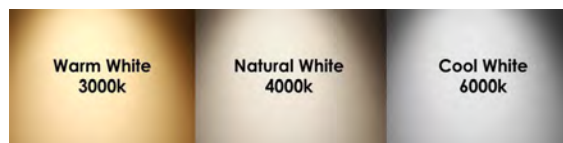

Obs.: A nossa fita de 12V/24V é vendida em rolos de 5 metros

Referencia	Led SMD	Led SMD	Lumens/Mt.	Temp. Cor	Voltagem	IP	Size	Cut	Preço/mt
232/CC2-24	22W/mt	2216-240	2 100	6000K+3000K	12VDC	20	10mm	5cm	9,87 €



## Fita Led 24V Alto Rendimento 26W/Mt. (Premium)



Obs.: A nossa fita de 12V/24V é vendida em rolos de 5 metros

Referencia	Potencia	Led SMD	Lumens/Mt.	Temp. Cor	Voltagem	IP	Size	Cut	Preço/mt
236N/860-24			3 770	6000K			10mm	5cm	
236N/828-24	26W	2835-224	3 630	2800K	24VDC	20	10mm	5cm	9,48 €
236N/840-24			3 700	4000K			10mm	5cm	

## Fita Led 24V 21,86W/Mt. (Premium)

### FITA RGB ALTA PERFORMANCE



Obs.: A nossa fita de 12V/24V é vendida em rolos de 5 metros

Referencia	Potencia	Led SMD	Lumens/Mt.	Temp. Cor	Voltagem	IP	Size	Cut	Preço/mt
400/RGB24	21.6W/Mt.	3535-120	1 500	R G B	24VDC	20	10mm	3cm	10,16 €

## Fita Led 24V WallWasher 15W-42W/Mt. (Premium)



Obs.: A nossa fita de 12V/24V é vendida em rolos de 5 metros

Referencia	Potencia	Led SMD	Lumens/Mt.	Temp. Cor	Voltagem	IP	Size	Cut	Preço/mt
502/827-24	15W/ Mt.	2835-42	1 350	2700K			18mm	16,6cm	24,38 €
502/860-24			1 500	6000K	24VDC	67	18mm	16,6cm	
502/RGB-24	42W/ Mt.	3030-36		R G B			18mm	16,6cm	33,41 €
502/KIT	Kit para Fita modelo 502			Composto por 1 Topo C/Furo e 1 S/Furo					1,00 €

**Fita Led 24V UV (Premium)**



120°  
CRI >80  
DIMMABLE  
3 ANOS GARANTIA

Referencia	Potencia	Led SMD	Lumens/Mt.	Temp. Cor	Voltagem	IP	Size	Cut	Preço/mt
244/UV	12W/ Mt.	2835-60	405nm	UV	24VDC	20	10mm	10cm	4,61 €

**Fita Led 24V MEAT (Premium)**



120°  
CRI >80  
DIMMABLE  
5 ANOS GARANTIA

Obs.: A nossa fita de 12V/24V é vendida em rolos de 5 metros

Referencia	Potencia	Led SMD	Lumens/Mt.	Temp. Cor	Voltagem	IP	Size	Cut	Preço/mt
244/MEAT120	13W/ Mt.	2835-120		3100K	24VDC	20	10mm	5cm	8,27 €

**Fita Led 24V RGB Digital WS2811 (Premium)**

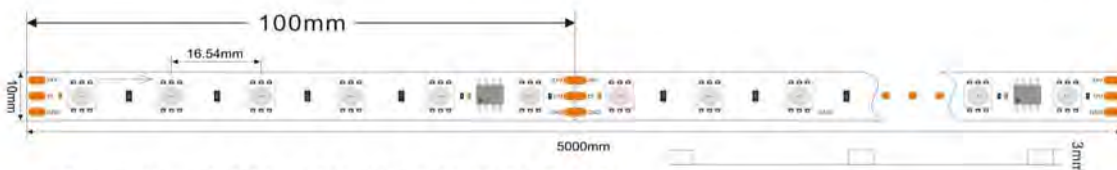

Obs.: A nossa fita de 12V/24V é vendida em rolos de 5 metros

Referencia	Potencia	Led SMD	Lumens/Mt.	Temp. Cor	Voltagem	IP	Size	Cut	Preço/mt
278	14,4W	5050-60		<b>R</b> <b>G</b> <b>B</b>	24VDC	20	10mm	10mm	8,58 €
279	23,4W	2835-120					8mm	5mm	9,09 €
280/827-24	10W	2835-120		2700K	24VDC	20	8mm	10mm	6,10 €
280/840-24				4000K					114

120°  
CRI >80  
DIMMABLE  
3 ANOS GARANTIA

# 29 Fita 230V



✂ 10CM



Obs: Precisa de Kit ligação 557/KIT

Nota: Kit C/ Topo Inicial + Topo Final + Fio C/20cm

Referencia	Potencia	Lumens/Mt.	Temp. Cor	Led SMD	Voltagem	Corte	Dimensão
557/860		1800	6000K				
557/840	17W/ Mt.	1 700	4000K	2835-120	200 - 250VAC	10cm	12mm
557/830		1 600	2800K				

## Fita Led 230VAC SMD2835



Referencia	Potencia	Lumens/Mt.	Temp. Cor	Preço/Mt
556/COB-50	11W/ Mt.	1 100	3000K	3,96 €
557/COB-50		1 200	6000K	

Obs: Precisa de Kit ligação 559/COB

Não são aceites devoluções de cortes de fita

Led SMD	Voltagem	Corte	Dimensão	Material
2835-120	200 - 250VAC	0,5mt	14,6x7,4 mm	Resina/PVC

## Fita Led 230VAC SMD2835



Referencia	Potencia	Lumens/Mt.	Temp. Cor	Preço/Mt
556/2835-50	16W/ Mt.	1 400	3000K	3,16 €

Obs: Precisa de Kit ligação 559

Não são aceites devoluções de cortes de fita

Led SMD	Voltagem	Corte	Dimensão	Material
2835-120	200 - 250VAC	0,5mt	14,6x7,4 mm	Resina/PVC

## Fita Led 230VAC SMD2835



Referencia	Potencia	Lumens/Mt.	Temp. Cor	Preço/Mt
556/180	18W/ Mt.	1 700	3000K	3,32 €

Obs: Precisa de Kit ligação 559/120

Não são aceites devoluções de cortes de fita

Led SMD	Voltagem	Corte	Dimensão	Material
2835-180	200 - 250VAC	1 mt	18x8,2 mm	Resina/PVC

## Fita Led 230VAC SMD5050



Referencia	Potencia	Lumens/Mt.	Temp. Cor	Preço/Mt
554	14,4W/Mt.		R G B	5,25 €
558	14,4W/Mt.		Blue	3,61 €

Obs: Precisa de Kit ligação 554/RF

Não são aceites devoluções de cortes de fita

Led SMD	Voltagem	Corte	Dimensão	Material
5050-60	200 - 250VAC	1 mt	14,6x7,4 mm	Resina/PVC

## Kit Ligação Fita Led 230VAC

**Obs:** Kit de ligação para fitas de Led 230V (Ref.556; 557; 557/120; 557/2835; 556/2835).

**Nota:** Fornecido em Kit C/ conector + Topo Final



**559**  
50 Mt Fita  
200 - 250VAC

**Preço Tabela**

**2,94 €**

**Obs:** Kit de ligação para fitas de Led 230V (Ref. 556/180; 557/180).

**Nota:** Fornecido em

Kit C/ conector + Topo Final

**559/120**  
50 Mt Fita  
200 - 250VAC

**Preço Tabela**

**2,06 €**

**Obs:** Kit de ligação para FITA LED COB

**559/COB**  
50 Mt Fita  
200 - 250VAC

**Preço Tabela**

**2,94 €**



Especificações técnicas:

Referencia

Potencia

Voltagem

Funcionamento

Dimensões

**554/RF**

1000 Mt Fita

200 - 250VAC

Control RGB RF

100X50X35mm

**Preço Tabela**

**20,42 €**

**Obs:** Controlador de Fita RGB 230VAC com comando. Fixa 8 cores diretas, diming em todas as cores, regulação de luminosidade e velocidade.

**Nota:** Fornecido em Kit C/ conector + Topo

## Acessórios Fita Led 230VAC

**Obs:** Braçadeira c/ 2 furos para aplicação de todas as fitas 230VAC, excepto ref. 556/2L e 557/2L.



Especificações técnicas:

Referencia

Tipo

**559/1**  
Braçadeira

**Preço Tabela**

**0,40 €**

**Obs:** Braçadeira c/ 2 furos para aplicação de todas as fitas 230VAC, excepto ref. 556/2L e 557/2L.



Especificações técnicas:

Referencia

Tipo

**559/2**  
Topo Final

**Preço Tabela**

**0,40 €**

**Obs:** União para aplicação de todas as fitas 230VAC, uma cor, excepto ref. 556/2L e 557/2L.



Especificações técnicas:

Referencia

Tipo

**559/3**  
União de fita

**Preço Tabela**

**0,40 €**

Fita Led 230VAC SMD2835



Referencia	Potencia	Lumens/Mt.	Temp. Cor	Preço/Mt
557/860		1 800	6000K	
557/840	17W/ Mt.	1 620	4000K	9,46 €
557/830		1 507	2758K	
Led SMD	Voltagem	Corte	Dimensão	Material
2835-120	200 - 250VAC	10cm	12mm	SILICONE



555/860		1 172	6000K	
555/840	10W/ Mt.	1 132	4000K	5,53 €
555/827		983	2700K	
Led SMD	Voltagem	Corte	Dimensão	Material
2835-60	200 - 250VAC	20cm	10mm	SILICONE

Obs: Precisa de Kit ligação 557/KIT

Não são aceites devoluções de cortes de fita. Quantidade mínima: 1mt



Nota: Kit C/ Topo Inicial + Topo Final + Fio C/20cm

557/KIT

1,00 €



Compatível com: SW-S3 + SW-RT4



Referencia	Potencia	Lumens/Mt.	Temp. Cor	Preço/Mt
557/RGB	10W/Mt.		R G B	10,78 €
Led SMD	Voltagem	Corte	Dimensão	Material
2835-96	200 - 250VAC	50cm	14x5mm	SILICONE

Nota: Kit C/ Topo Inicial + Topo Final + Fio C/20cm

557/KIT-RGB

1,99 €

# 30 EI Wire-Neon Flex



Referencia	Potencia	Lumens/Mt.	Temp. Cor	Led SMD	Voltagem	Corte	Dimensão
NE24V-RGB	12W		R G B	SMD 2835-120	24VDC	3cm	6X12mm

## Fio Electroluminescente (EI Wire)

Obs: O fio EI Wire funciona somente com conversor, não é possível conectar directamente. A tensão varia consoante o comprimento do fio. Este fio é vendido ao metro, com quantidade mínima de 3 metros. Não se aceitam devoluções de cortes de fio.



360°  
CRI >80  
IP 65

Referencia	Temp. Cor	Voltagem	Preço
596	Limão	80-90VAC a)	2,84 €
597	Laranja		
598	Sky Blue		
599	Vermelho		
600	PINK		
602	VERDE		
603	AZUL		
604	ROSA		
Frequência	Cº Funcionamento	Dimensão	Material
1000 - 2000HZ	-40º a 80º Celcius	Ø 2,3mm	Silicone

## Conversores para EI Wire



Referencia	Potencia	Voltagem	Preço
611	5 mt EI Wire	12VDC	5,63 €
Funcionalidade	Fixação	Dimensão	
Estático		53X33X29mm	



Referencia	Potencia	Voltagem	Preço
612	10 mt EI Wire	12VDC (isquero)	6,75 €
Funcionalidade	Fixação	Dimensão	
Estático		53X33X29mm	



Referencia	Potencia	Voltagem	Preço
606	10 mt EI Wire	230VAC	14,63 €
Funcionalidade	Fixação	Dimensão	
Estático		70X47X45mm	



Referencia	Potencia	Voltagem	Preço
607	30 mt EI Wire	230VAC	15,75 €
Funcionalidade	Fixação	Dimensão	
Estático		136X90X27mm	



Referencia	Potencia	Voltagem	Preço
608	50 mt EI Wire	230VAC	29,25 €
Funcionalidade	Fixação	Dimensão	
Estático		141X100X33mm	



Referencia	Potencia	Voltagem	Preço
609	1000 mt EI Wire	230VAC	49,50 €
Funcionalidade	Fixação	Dimensão	
Estático		148X100X34mm	



## Neon Flex 24V

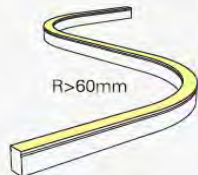
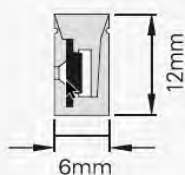

Obs: Rolo de 50 mt, comercializado ao metro, quantidade mínima 1 mt. Não são aceites devoluções de cortes de Neon.

Referencia	Potencia	Lumens	Temp. Cor	Preço/Mt
NE24V-3	12W	750 Lm/Mt	3000K	7,10 €
NE24V-4			4000K	7,79 €
NE24V-RED			Vermelho	7,79 €
NE24V-BLUE			Azul	7,79 €
NE24V-RGB			R G B	12,69 €
NE24V-3-5M	750 Lm/Mt	750 Lm/Mt	3000K	6,38 €
NE24V-4-5M			4000K	11,40 €
NE24V-RGB-5M			R G B	11,40 €
Led	Voltagem	Corte	Dimensão Ø	
SMD 2835-120	24VDC	5cm	6x12mm	PVC/Plástico

Obs: Vendido em Rolos de 5mt

## Acessórios Neon Flex 24v



Bendable profile  
L1000\*W8\*H12.2mm



Referencia	Acessorio	Descrição	Dimensão	Preço/Mt
777/NE24	Perfil	Perfil de Alumínio dobrável	1000x8x12,2mm	2,92 €
777/5M	Perfil	Perfil de Alumínio	1000x8x13,5mm	4,41 €
TP-NE24	Kit	Kit ligação composto por dois topos e cabo c/25cm	20x14x17mm	1,00 €



## Neon Flex 24V

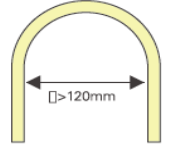
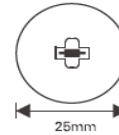

Obs: Vendido em rolos de 5mt

Referencia	Potencia	Lumens	Temp. Cor	Led	Voltagem	Corte	Preço/mt
NE24-D25-4	14W	1005Lm/Mt	4000K	SMD 2835-320	24VDC	6,25cm	40,34 €
NE24-D25-3		994 Lm/Mt	3000K				

## Acessórios Neon Flex 24v

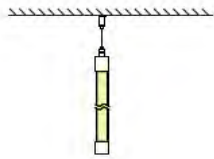

Vertical pendant accessory Kit



Referencia	Acessorio	Obs:	Dimensão	Preço
FP-D25-1		Pendente vertical		33,74 €

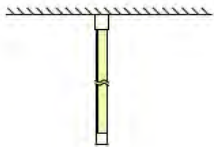

Vertical surface mounted accessory kit



Referencia	Acessorio	Obs:	Dimensão	Preço
FP-D25-3		Superfície Vertical		26,64 €

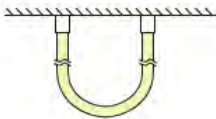

Double ended Vertical surface mounted accessory kit



Referencia	Acessorio	Obs:	Dimensão	Preço
FP-D25-5		Superfície Vertical c/dois fixadores		25,12 €

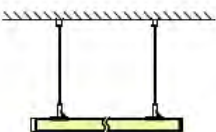

Horizontal pendant accessory Kit



Referencia	Acessorio	Obs:	Dimensão	Preço
FP-D25-6		Suspensão Horizontal		12,94 €

## Controladores RGB-CCT-DIM-DMX



OLED screen interface, easy operation, clear display

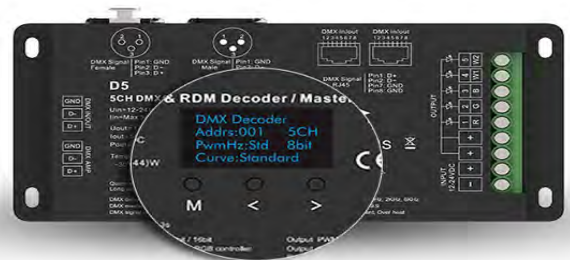
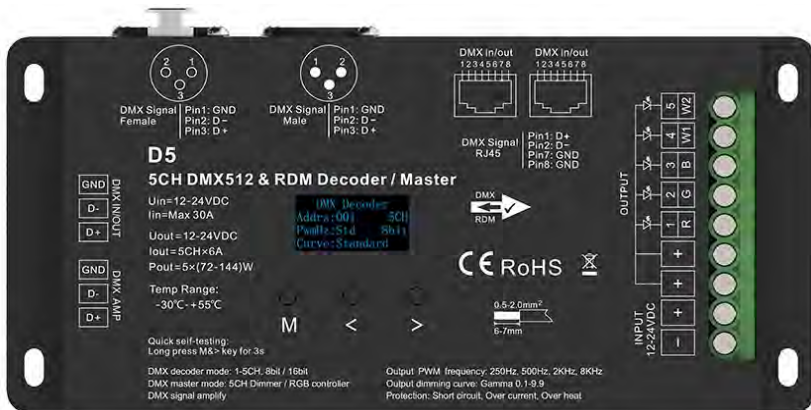

Referencia	Alimentação	Saida	Saida Max.	Função	Dimensão
SW-D5	12-24VDC	5 Canais x 6A	12VDC - 360W / 24VDC - 720W	Master & Decoder Mode, Função RDM	170x80x40

## KIT Dimmer



Obs: Comando touch; Dimming suave de 0-100%; Tecnologia Wireless 2,4GHz com capacidade até 30 metros. Nota: Kit composto por 1 controlador + Comando

Sinal de saída	RF(2,4GHz)
Alimentação	3VDC (CR2032)
Duração em Standby	1 Ano
Alcance	>30 Mt
Temp. Funcionamento	min. -30 max.+55°C
Dimensões	107x58,5x9mm
Peso	34g

Referencia	Potencia	Saída	Saída Máx.	Push Dim	Material	Dimensão	Preço
SW-R6-1+SW-V1	12-24VDC	1 Canal x 8A	12VDC - 96W / 24VDC - 192W	Sim	Plástico	97x33x18mm	23,67 €

## KIT RGB+W



## Especificações técnicas:

Obs: Comando touch; RGB até 16Milhoes de cores; Inclui 10 Modos Dinâmicos; Tecnologia Wireless 2,4GHz com capacidade até 30 mt. Nota: Kit composto por 1 controlador + Comando

Sinal de saída	RF(2,4GHz)
Alimentação	3VDC (CR2032)
Duração em Standby	1 Ano
Alcance	>30 Mt
Temp. Funcionamento	min. -30 max.+55°C
Dimensões	107x58,5x9mm
Peso	34g

Referencia	Alimentação	Saída	Saída Máx.	Push Dim	Função	Dimensão	Preço
SW-R8+VP	12-24VDC	4 Canais x 4A	12VDC - 192W / 24VDC - 384W	Não	RGBW	114x38x20mm	30,01 €
SW-R8+V3	12-24VDC	3 Canais x 4A	12VDC - 144W / 24VDC - 288W	Não	RGBW	114x38x20mm	27,48 €

## Comando 1 Zona - RGBW / SPI

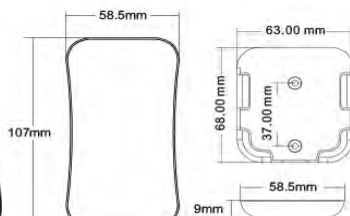

Obs: Comando touch; Dimming suave de 0-100%; Tecnologia Wireless 2,4GHz com capacidade até 30 metros.

Sinal de saída	RF(2,4GHz)
Alimentação	3VDC (CR2032)
Duração em Standby	1 Ano
Alcance	>30 Mt
Temp. Funcionamento	min. -30 max.+55°C
Dimensões	107x58,5x9mm
Peso	34g

Referencia	Compatibilidade	Função	Dimensão	Preço
SW-R9	SW-VP / SW-V4/ SW-V5/ SW-WT-SPI	RGBW - Controlo de cor + Branco	122x53x17,5mm	13,52 €

## Comando 1 Zona - RGBW

**Especificações técnicas:**

Obs: Comando touch RGB até 16Milhoes de cores; Inclui 10 Modos Dinâmicos; Tecnologia Wireless 2,4GHz com capacidade até 30 mt .

Sinal de saída	RF(2,4GHz)
Alimentação	3VDC (AAx2)
Duração em Standby	1 Ano
Alcance	>30 Mt
Temp. Funcionamento	min. -30 max.+55°C
Zonas de Controlo	1 Zona
Índice de Protecção	IP20
Certificado	CE , RoHS , EMC , LVD , RED

Referencia	Compatibilidade	Função	Dimensão	Preço
SW-RT1	Todos os Controladores da Gama SW	DIMMER	122x53x17,5mm	16,92 €
SW-RT4	SW-VP / SW-V4/ SW-V5	RGBW - Controlo de cor + Branco		

## Comando 4 Zonas - RGBW / CCT / DIMMER / RGB+CCT



Sinal de saída	RF(2,4GHz)	Temp. Funcionamento	min. -30 max.+55°C
Alimentação	3VDC (AAx2)	Zonas de controlo	4 Zonas Independentes
Duração em Standby	2 Anos	Certificado	CE , RoHS , EMC , LVD , RED
Alcance	>30 Mt	Índice de Protecção	IP20

Referencia	Compatibilidade	Função	Dimensão	Preço
SW-RT6	Todos os Controladores da Gama SW	DIMMER - Controlo da intensidade de luz	122x53x17,5mm	18,19 €
SW-RT7	SW-VP / SW-V4/ SW-V5	CCT - Controlo da Tonalidade		
SW-RT9	SW-VP / SW-V4/ SW-V5	RGBW - Controlo de cor + Branco		
SW-RT10	SW-V5	RGB+CCT - Controlo de cor + Tonalidade		

## Comando ON-OFF / DIMMER



R11

R1-1



	SW-RU4	SW-R11/R1-1
Sinal de saída	RF(2,4GHz)	
Alimentação	3VDC (CR2032)	
Duração em Standby	2 Anos	
Alcance	>30 Mt	
Temp. Funcionamento	min. -30 max.+55°C	
Zonas de controlo	4 Zonas	1 Zona
Certificado	CE , EMC , LVD , RED	
Índice de Protecção	IP20	

Referencia	Compatibilidade	Função	Dimensão	Preço
SW-RU4	Todos os Controladores da Gama SW	ON/OFF e DIMMER - Controlo da intensidade de luz	135x40x11mm	13,52 €
SW-R11				13,95 €
SW-R1-1				11,47 €

## Comando 8 Zonas - Dimmer

**Especificações técnicas:**

**Obs:** Comando touch RGB até 16Milhoes de cores; Inclui 10 Modos Dinâmicos;Tecnologia Wireless 2,4GHz com capacidade até 30 mt .

Sinal de saída	RF(2,4GHz)
Alimentação	3VDC (AAAx2)
Duração em Standby	1 Ano
Alcance	>30 Mt
Temp. Funcionamento	min. -30 max.+55°C
Zonas de Controlo	8 Zonas
Índice de Proteção	IP20
Certificado	CE , RoHS , EMC , LVD , RED

Referencia	Compatibilidade	Função	Dimensão	Preço
SW-RT8	Todos os Controladores da Gama SW	Dimmer	122x53x17,5mm	18,19 €

## Comando 8 Zonas - RGBW

**Especificações técnicas:**

**Obs:** Comando touch RGB até 16Milhoes de cores; Inclui 10 Modos Dinâmicos;Tecnologia Wireless 2,4GHz com capacidade até 30 mt .

Sinal de saída	RF(2,4GHz)
Alimentação	3VDC (AAAx2)
Duração em Standby	1 Ano
Alcance	>30 Mt
Temp. Funcionamento	min. -30 max.+55°C
Zonas de Controlo	8 Zonas
Índice de Proteção	IP20
Certificado	CE , RoHS , EMC , LVD , RED

Referencia	Compatibilidade	Função	Dimensão	Preço
SW-RS8	SW-VP / SW-V4/ SW-V5	RGBW - Controlo de côr + Branco	141x50x17,5mm	20,30 €



## Comando de Parede Superfície RGB-RGB+W / DIMMER

**T24B****T20B****T25B**

Sinal de saída	RF(2,4GHz)
Alimentação	3VDC (AAAx2)
Duração em Standby	2 Anos
Alcance	>30 Mt

Temp. Funcionamento	min. -30 max.+55°C
Zonas de controlo	4 Zonas Independentes
Certificado	CE, RoHS, EMC, LVD, RED
Índice de Protecção	IP20

Referencia	Compatibilidade	Função	Dimensão	Preço
SW-T20B SW-T20P SW-T24B SW-T25B	Todos os Controladores da Gama <b>SW</b> SW-VP / SW-V4 / SW-V5 SW-V5 / SW-WT5	DIMMER - Controlo da intensidade de luz RGBW - Controlo de cor + Branco RGB+CCT - Controlo de cor + Tonalidade	122x53x17,5mm	27,91 €

## Comando de Parede Encastre RGB-RGB+W / DIMMER

**T14****T15****T16**

Sinal de saída	RF(2,4GHz) + DMX512
Alimentação	100-240V
Duração em Standby	2 Anos
Alcance	>30 Mt

Temp. Funcionamento	min. -30 max.+55°C
Zonas de controlo	4 Zonas Independentes
Certificado	CE, RoHS, EMC, LVD, RED
Índice de Protecção	IP20

Referencia	Compatibilidade	Função	Dimensão	Preço
SW-T14 SW-T15 SW-T16	SW-VP / SW-V4 / SW-V5 SW-V5 / SW-WT5 Todos os Controladores da Gama <b>SW</b>	RGBW - Controlo de cor + Branco RGB+CCT - Controlo de cor + Tonalidade DIMMER - Controlo da intensidade de luz	86x86x36,5mm	27,91 €

## Controlador RGB / RGB+W / CCT / DIMMER 12-24VDC



Sinal de Entrada	RF(2,4GHz)
Nível de Intensidade	4096 Níveis
Gama de intensidade	0 - 100%
Alcance	>30 Mt

Temp. Funcionamento	min. -30 max.+55°C
Protecção	Polaridade Invertida
Certificado	CE , RoHS , EMC , LVD , RED
Índice de Protecção	IP20

Referencia	Alimentação	Saída	Saída Máx.	Push Dim	Função	Dimensão	Preço
SW-V1		1 Canal x 8A	12VDC - 96W / 24VDC - 192W	Sim	DIMMER	97x33x18mm	10,64 €
SW-V1-L		1 Canal x 15A	12VDC - 180W / 24VDC - 360W	Sim	DIMMER	160x45x27mm	16,92 €
SW-WT1		2 Canais x 5A	12VDC - 120W / 24VDC - 240W	Sim	DIM + CCT <b>tuya</b>	114x38x20mm	24,53 €
SW-VP	12-24VDC	4 Canais x 4A	12VDC - 192W / 24VDC - 384W	Não	RGB/RGBW/CCT/DIM	114x38x20mm	15,22 €
SW-V4		4 Canais x 5A	12VDC - 240W / 24VDC - 480W	Sim	RGB/RGBW/CCT/DIM	160x45x27mm	19,00 €
SW-V5		5 Canais x 5A	12VDC - 300W / 24VDC - 600W	Sim	RGB + CCT	160x45x27mm	22,53 €
SW-WT5		5 Canais x 3A	12VDC - 180W / 24VDC - 360W	Não	RGB + CCT + <b>tuya</b>	114x38x20mm	26,98 €

## Controlador RGB / Dimmer 230VAC



Sinal de Entrada	RF(2,4GHz)
Alcance	>30 Mt
Gama de intensidade	0 - 100%

Temp. Funcionamento	min. -30 max.+55°C
Índice de Protecção	IP20
Certificado	CE , RoHS , EMC , LVD

Referencia	Alimentação	Saída	Saída Máx.	Push Dim	Função	Dimensão	Preço
SW-S1		1 Canal x 2A	240VAC - 480W	Não		103x67x31mm	20,19 €
SW-S1B	100-240VAC	1 Canal x 1,5A	240VAC - 360W	Sim	DIMMER	52x52x26mm	19,00 €
SW-S1-BWT		1 Canal x 1,5A	240VAC - 360W	Sim	DIMMER + <b>tuya</b>	52x52x26mm	27,48 €
SW-S3-WT		3 Canal x 1,5A	240VAC - 720W	Não	RGB + <b>tuya</b>	160x45x27mm	35,09 €



## Controlador ON / OFF 230VAC

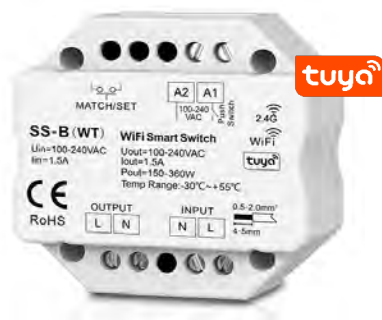

Smart life. smart living



Sinal de Entrada	RF(2,4GHz)
Alcance	>30 Mt
Compatibilidade	Comando SW-RU4

Temp. Funcionamento	min. -30 max.+55°C
Indice de Protecção	IP20
Certificado	CE , RoHS , EMC , LVD

Referencia	Alimentação	Saida	Saida Máx.	Push	Função	Dimensão	Preço
SW-SS-C	100-240VAC	1 Canal x 3A	100-240VAC / 300W-720W	Sim	ON / OFF	52x52x27mm	18,19 €
SW-SS-BWT		1 Canal x 1,5A	100-240VAC / 150W-360W		ON / OFF +		26,21 €

## Controlador Dimmer 0-10V

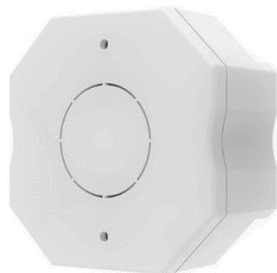

Sinal de Entrada	RF(2,4GHz)
Alcance	>30 Mt
Compatibilidade	Comando Dimmer gama SW

Temp. Funcionamento	min. -30 max.+55°C
Indice de Protecção	IP20
Certificado	CE , RoHS , EMC , LVD

Referencia	Alimentação	Saida	Saida Máx.	Push Dim	Função	Dimensão	Preço
SW-L1	85-265VAC	1 Canal x 1,5A	240VAC - 360W	Sim	Dimmer	52x52x27mm	19,00 €
SW-L1WT					Dimmer +		27,91 €

## Controlador ZIGBEE 3.0 12/24VDC - 2 / 4 Canais

# ZigBee 3.0

## Constant voltage LED Controller

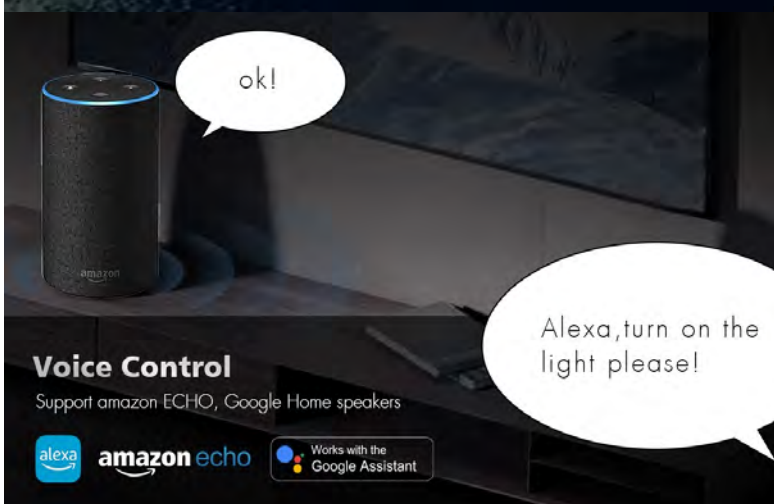

### Compatible with Philip HUB

Achieve Philips HUE App control by connect with Philips HUE bridge



Sinal de Entrada	Zigbee 3.0
Alcance	>30 Mt
Compatibilidade	Comando gama SW

Temp. Funcionamento	min. -30 max.+55°C
Indice de Protecção	IP20
Certificado	CE , RoHS , EMC , LVD

Referencia	Alimentação	Saida	Saida Máx.	Função	Dimensão	Preço
SW-WZS1	12-24VDC	2 Canais x 5A	12VDC - 120W / 24VDC - 240W	DIMMER	160x45x27mm	27,20 €
SW-WZS4		4 Canais x 3A	12VDC - 144W / 24VDC - 288W	RGBW		28,80 €

## Controlador DMX 512 - 3 / 4 Canais



Função	DIP Switch / RDM
Protocolo	DMX512
Temp. Funcionamento	min. -30 max.+55°C

Protecção	Polaridade Invertida
Certificado	CE , RoHS , EMC , LVD
Índice de Protecção	IP20

Referencia	Alimentação	Saída	Saída Máx.	Sinal Entrada	Dimensão	Preço
SW-D3-M		3 Canais x 8A	12VDC - 288W / 24VDC - 576W	3-PinXLR, Terminal Verde DMX	128x69x39mm	27,15 €
SW-D4-M	12-24VDC	4 Canais x 6A				28,79 €
SW-PX-04		4 Canais x 8A	12VDC - 384W / 24VDC - 768W	RJ45, Terminal Verde DMX	140x50x26mm	30,34 €

## Controlador DMX 512 - 5 Canais - OLED Display

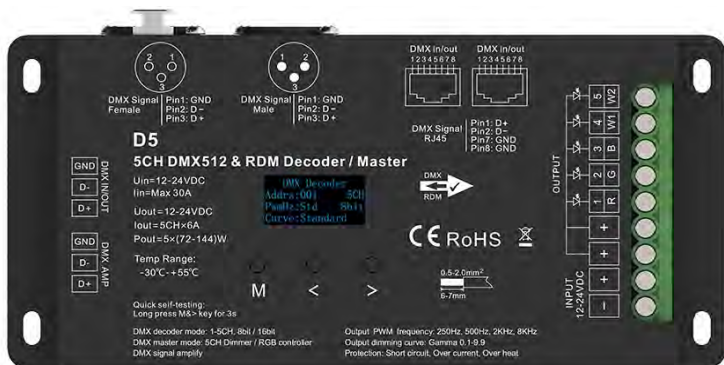

Sinal de Entrada	3-PinXLR,RJ45,Terminal Verde DMX
Protocolo	DMX512
Temp. Funcionamento	min. -30 max.+55°C
	25 Programas RGB Incorporados, Velocidade e Brilho ajustável
Protecção	Polaridade Invertida
Certificado	CE , RoHS , EMC , LVD
Índice de Protecção	IP20
Frequência PWM	250/ 500/ 2000/ 8000Hz

Referencia	Alimentação	Saída	Saída Máx.	Função	Dimensão	Preço
SW-D5	12-24VDC	5 Canais x 6A	12VDC - 360W / 24VDC - 720W	Master & Decoder Mode, Função RDM	170x80x40	138,27 €

## Controlador DMX 512 - 5 Canais



Sinal de Entrada	RJ45, Terminal Verde DMX
Protocolo	DMX512
Temp. Funcionamento	min. -30 max.+55°C
Frequência PWM	250/ 500/ 2000/ 8000Hz
Protecção	Polaridade Invertida
Certificado	CE , RoHS , EMC , LVD
Índice de Protecção	IP20

Referencia	Alimentação	Saída	Saída Máx.	Função	Dimensão	Preço
SW-D5-E	12-24VDC	5 Canais x 4A	12VDC - 240W / 24VDC - 480W	Decoder Mode, Função RDM	175x46x32	37,97 €

## Controlador DC Dali Dimmer 12/24VDC - 1 / 4 Canais

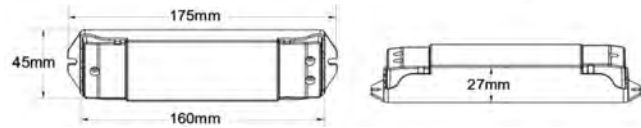

Endereçamento DALI efetuado automaticamente através do DALI Master

Sinal de Entrada	DALI + PUSH DIM
Protocolo	IEC 62386-102, 62386-207
Temp. Funcionamento	min. -30 max. +55°C

Protecção	Polaridade Invertida
Certificado	CE, RoHS, EMC, LVD
Índice de Protecção	IP20

Referencia	Alimentação	Saída	Saída Máx.	Função	Dimensão	Preço
SW-DA1	12-24VDC	1 Canal x 15A	12VDC - 180W / 24VDC - 360W	DALI Dimmer - 1 DALI Address	160x45x27mm	20,33 €
SW-DA4	12-24VDC	4 Canais x 5A	12VDC - 240W / 24VDC - 480W	DALI Dimmer - 4 DALI Address	160x45x27mm	21,20 €

## Controlador AC Triac Dali Dimmer 230VAC

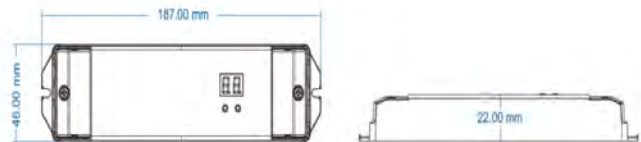
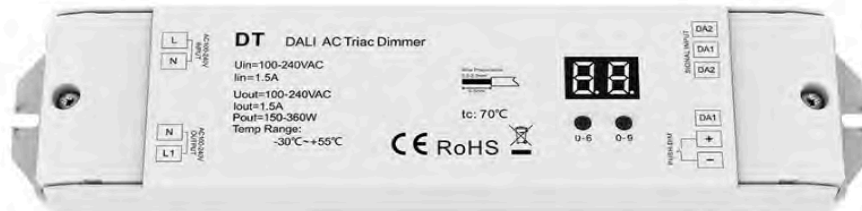

Sinal de Entrada	DALI + PUSH DIM
Protocolo	IEC 62386-102, 62386-207
Temp. Funcionamento	min. -30 max. +55°C

Protecção	Polaridade Invertida
Certificado	CE, RoHS, EMC, LVD
Índice de Protecção	IP20

Endereçamento DALI pode ser feito manualmente através do display digital ou automaticamente através do DALI Master

Referencia	Alimentação	Saída	Saída Máx.	Função	Dimensão	Preço
SW-DT	100-240VAC	1 Canal x 1,5A	240VAC - 360W	DALI Dimmer - PUSH DIM	187x46x22	26,50 €

## Controlador SPI 5-24VDC

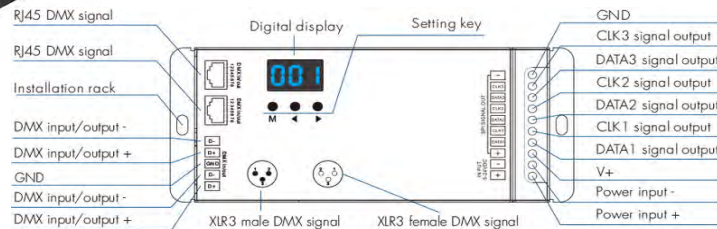

Sinal de Entrada	DMX512 + RF(2,4Ghz)
Sinal de saída	SPI (TTL) X 3
Temp. Funcionamento	min. -30 max.+55°C
Control Dots	170Pixels (RGB510CH)Max.900

Protecção	Polaridade Invertida
Certificado	CE , RoHS , EMC , LVD
Índice de Protecção	IP20
Dynamic Modes	32

Referencia	Alimentação	Saída	Saída Max.	Função	Dimensão	Preço
SW-DSA	100-240VAC	1 Canal x 1,5A	240VAC - 360W	DMX512 - SPI	187x46x22	57,85 €

## KIT SPI



Obs: Comando touch; Controlador com sinal de saída SPI para RGB/RGBW; 32 Modos dinâmicos incluídos; Tecnologia Wireless 2,4GHz com capacidade até 30 metros. Nota: Kit composto por 1 controlador + Comando

Sinal de saída	RF(2,4GHz)
Alimentação	5-24VDC - Comando(CR2032)
Duração em Standby	1 Ano
Control Dots	50 Pixels Max.3200
Temp. Funcionamento	min. -30 max.+55°C
Dimensões	107x58,5x9mm
Peso	34g

Referencia	Potencia	Pontos Saída	Sinal Saída	Push Dim	Material	Dimensão	Preço
SW-SC+R9	5-24VDC	1024 Max	SPI(DATA/CLK)	Não	Plástico	97x33x18mm	35,09 €

## Controlador SPI TUYA 5-24VDC

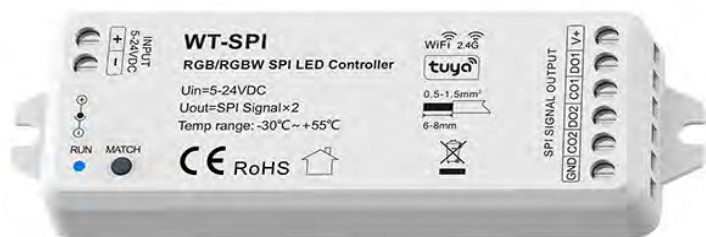

Compatível com Fita LED 278 e 279

Referencia	Potencia	Pontos Saída	Sinal Saída	Push Dim	Material	Dimensão	Preço
SW-WT-SPI	5-24VDC	1024 Max	SPI(DATA/CLK)X2	Não	Plástico	114x38x20mm	27,58 €

## Controlador RGB - SPI 5-24VDC



Compatível com Fita LED 278 e 279

Referencia	Potencia	Pontos Saida	Sinal Saida	Push Dim	Material	Dimensão	Preço
SP002E	5-24VDC	1024 Max	SPI	Não	Plástico	114x38x20mm	4,41 €

## Controlador Cor Única - SPI 5-24VDC



Sinal de saída	App + RF(2,4GHz)
Alcance	>30 Mt
Temp. Funcionamento	min. -10 max.+55°C
Temporizador	ON/OFF
Efeitos de Animação	ON/OFF
Som	Através do Telefone / Microfone Incorporado

Compatível com Fita LED 280/827-24 e 280/840-24

Referencia	Potencia	Pontos Saida	Sinal Saida	Push Dim	Material	Dimensão	Preço
SP646E	5-24VDC	1800 Max	SPI	Não	Plástico		11,15 €

## Controlador Motor Estore TUYA

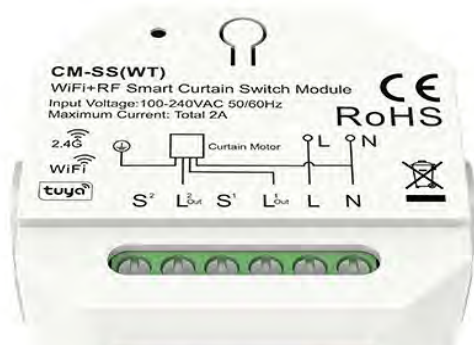

Sinal de saída	TUYA App + RF(2,4GHz)
Alcance	>30 Mt
Temp. Funcionamento	min. -10 max.+55°C
Dimensões	56x56x35mm
Peso	66g

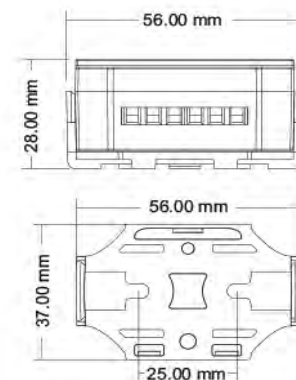
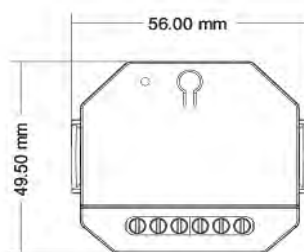
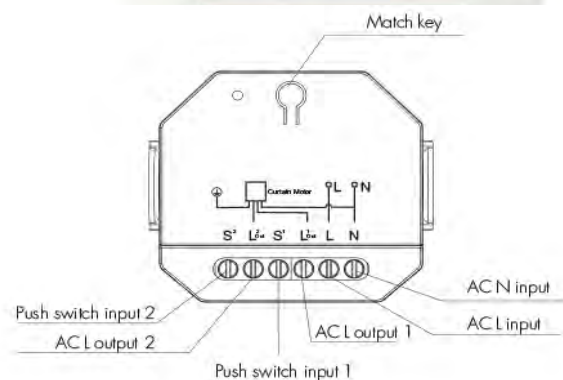

Referencia	Potencia	Potência Saida	Push Dim	Material	Dimensão	Preço
SW-CM-SSWT	100-240VAC	480W	Sim	Plástico	56x56x35mm	20,33 €

# 32 Sensores



Referencia	Alimentação	Saída	Saída Máx.	Função	Dimensão
SW-ES32	12-24VDC	32 Canais x 1A	12VDC - 384W / 24VDC - 768W	Constant Voltage + SPI (TTL)	170x80x40

## Sensor Movimento PIR

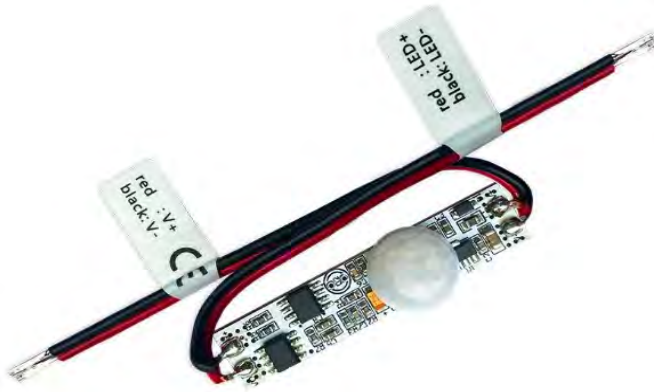

**Obs:** Sensor de pequenas dimensões.

**ON** - Quando pessoas ou objectos entram no seu raio de ação.

**OFF** - Quando os mesmos se afastam e após 30s.

Normalmente instalado em perfil de alumínio.

Alcance	Até 3 Mt
Ângulo de detecção	120
Temp. Funcionamento	min. -30 max. +55°C

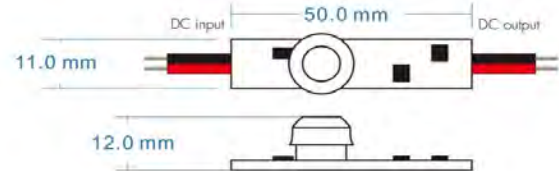

Protecção	Polaridade Invertida
Certificado	CE , EMC , LVD
Índice de Protecção	IP20

Referencia	Alimentação	Saída	Saída Máx.	Função	Dimensão	Preço
SW-E1-R	12-24VDC	1 Canal x 3A	12VDC - 36W / 24VDC - 72W	PIR Motion Sensor Switch	50x11x12mm	6,63 €

## Touch Dimmer 12/24V

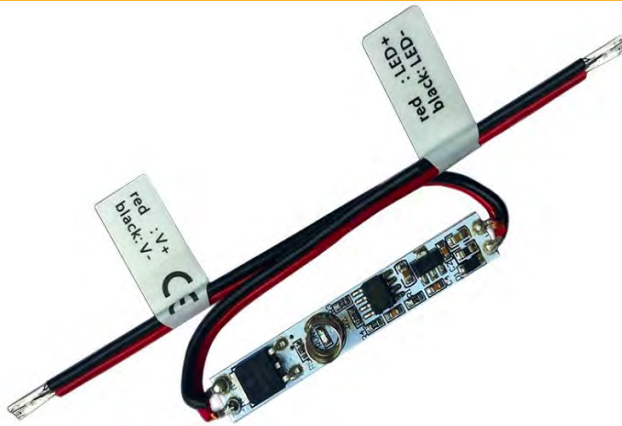

## Especificações técnicas:

**Obs:** Para perfil de led touch, controlado através da tampa. Com um só toque desliga, se mantiver pressionado aumenta ou diminui a intensidade.

Nota: Led azul de identificação StandBy



Referencia	Alimentação	Saída	Saída Máx.	Função	Dimensão	Preço
SW-E1-C	12-24VDC	1 Canal x 3A	12VDC - 36W / 24VDC - 72W	Touch Dimmer p/ perfil	50x7,8x10mm	6,63 €

## Sensor para Porta de Roupeiro



## Especificações técnicas:

**Obs:** Para instalação em perfil de led. Abrindo a porta liga gradualmente, ao fechar a porta desliga gradualmente.

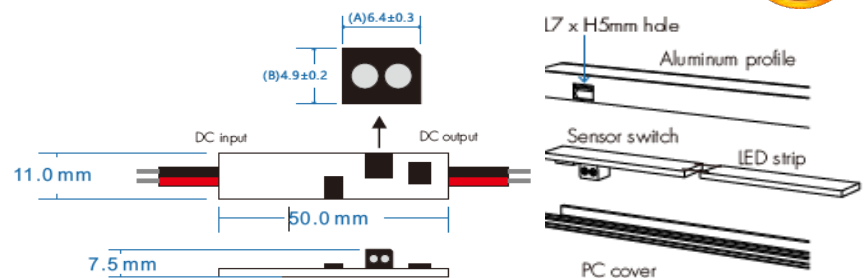

Alcance	Até 8 Cm
Ângulo de detecção	15-30cm

Protecção	Polaridade Invertida
Certificado	CE , EMC , LVD

Referencia	Alimentação	Saída	Saída Máx.	Função	Dimensão	Preço
SW-E1-D	12-24VDC	1 Canal x 3A	12VDC - 48W / 24VDC - 96W	Sensor P/Roupeiro	50x7,8x10mm	6,63 € 136



## Kit Sensor Movimento PIR 12/24V



**Obs:** Sensor de pequenas dimensões.

**ON** - Quando pessoas ou objectos entram no seu raio de ação.

**OFF** - Quando os mesmos se afastam e após 30s.

Alcance	Até 3 Mt
Ângulo de detecção	120

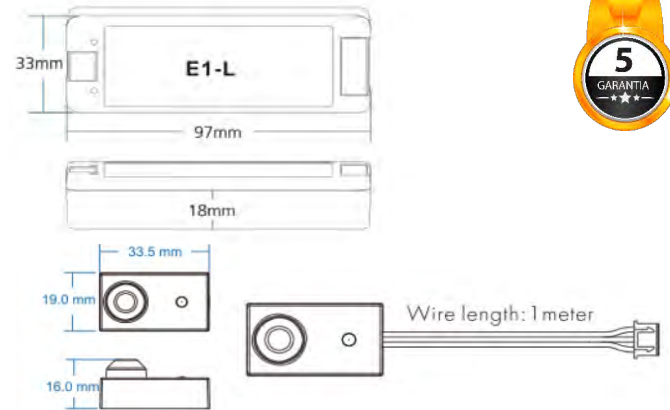

Protecção	Polaridade Invertida
Certificado	CE , EMC , LVD

Referencia	Alimentação	Saida	Saida Max.	Função	Dimensão	Preço
SW-E1L-ER	12-24VDC	1 Canal x 8A	12VDC - 96W / 24VDC - 198W	Sensor Movimento PIR	97x33x18mm	12,80 €

## Kit Sensor Movimento PIR 230VAC



**Obs:** Sensor de pequenas dimensões.

**ON** - Quando pessoas ou objectos entram no seu raio de ação.

**OFF** - Quando os mesmos se afastam e após 30s.

Alcance	Até 3 Mt
Ângulo de detecção	120

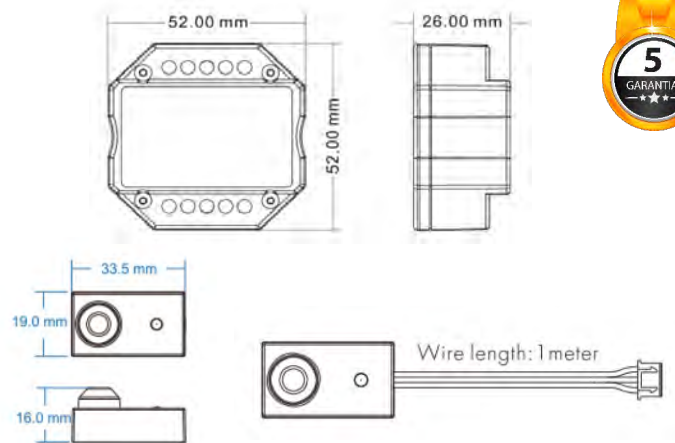

Protecção	Polaridade Invertida
Certificado	CE , EMC , LVD, RED

Referencia	Alimentação	Saida	Saida Max.	Função	Dimensão	Preço
SW-E1H-ER	100-240VAC	1 Canal x 3A	240VAC - 720W	Sensor Movimento PIR	52x52x26mm	20,30 €

Sensores DIY



Sensor DIY 12/24VDC

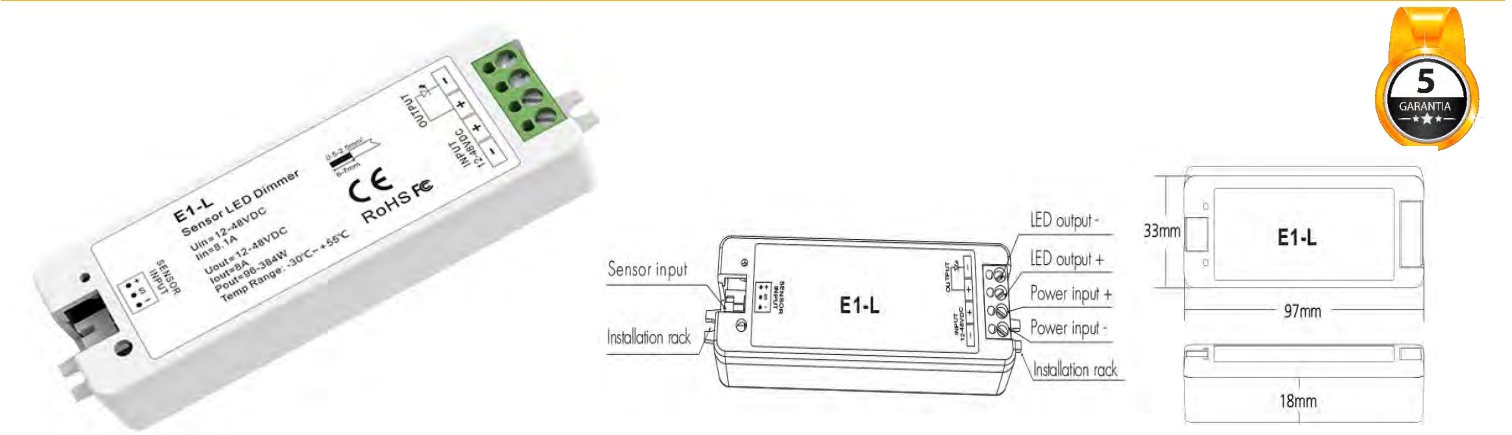

Índice de Protecção	IP20
Temp. Funcionamento	min. -30 max.+55°C

Protecção	Polaridade Invertida
Certificado	CE , EMC , LVD

Referencia	Alimentação	Saída	Saída Max.	Função	Dimensão	Preço
SW-E1L	12-24VDC	1 Canal x 8A	12VDC - 96W / 24VDC - 198W	Controlador para Sensor DIY	97x33x18mm	7,18 €

Sensor DIY 230AC

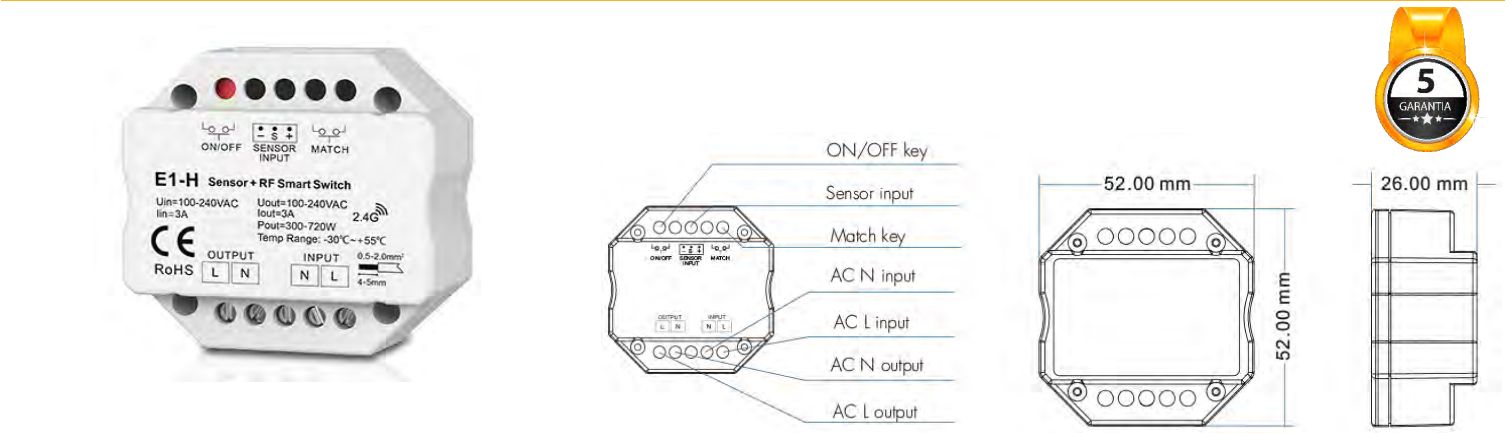

Índice de Protecção	IP20
Temp. Funcionamento	min. -30 max.+55°C

Protecção	Polaridade Invertida
Certificado	CE , EMC , LVD , RED

Referencia	Alimentação	Saída	Saída Max.	Função	Dimensão	Preço
SW-E1H	100-240VAC	1 Canal x 3A	240VAC - 720W	Controlador para Sensor DIY	52x52x26mm	14,79 €

## Sensor DIY Microondas

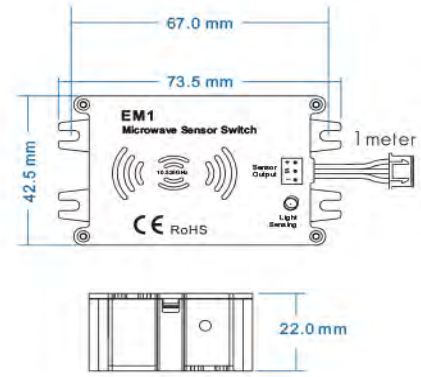

Alcance	Max.(DxH) 20 x 15Mt
Ângulo de detecção	Instalação Parede 150º/Teto 360º
Altura de Instalação	Max.15Mt

Sensibilidade de detecção	10%, 25%, 50%, 75%, 100%
Sensibilidade Luminosa ( Lux)	10, 30, 50, 100, 150,200,Desligado
Deteção de Movimento	0,5 - 3m/s

Referencia	Alimentação	Saida	Saida Max.	Função	Dimensão	Preço
SW-EM1				Sensor Microondas	67x42,5x22mm	16,92 €

## Sensor DIY para Porta de Roupeiro

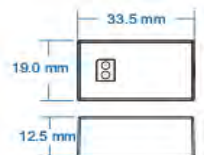

Alcance	Até 10 Cm
Ângulo de detecção	15 - 30º

Protecção	Polaridade Invertida
Certificado	CE , EMC , LVD

Referencia	Alimentação	Saida	Saida Max.	Função	Dimensão	Preço
SW-ED				Sensor Porta Roupeiro	33,5x19x12,5mm	3,81 €

## Sensor DIY Passagem

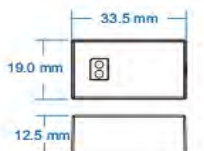
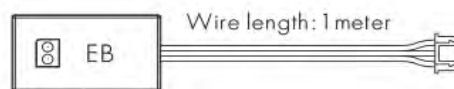

Alcance	Até 8 Cm
Ângulo de detecção	15 - 30º

Cabo de Ligação	1 Mt
Certificado	CE , EMC , LVD

Referencia	Alimentação	Saida	Saida Max.	Função	Dimensão	Preço
SW-EB				Sensor Passagem	33,5x19x12,5mm	3,81 €

Sensor PIR de escadas - 32 Canais - OLED Display



- Facilidade de uso com ecrã Oled e 3 botões
- 4 modos de funcionamento seleccionáveis
- 2 Sensores de Movimento
- Multiplos modos de cor incorporados, velocidade 1-8 Ajustável
- Função de auto-teste



Daylight sensor (30cm)  
1 pcs



PIR sensor  
2 pcs



PIR sensor extension line (5m)  
2 pcs

Alcance	Até 3 Mt
Ângulo de detecção	120
Temp. Funcionamento	min. -30 max. +55°C

Protecção	Polaridade Invertida
Certificado	CE , EMC , LVD
Índice de Protecção	IP20

Referencia	Alimentação	Saida	Saida Máx.	Função	Dimensão	Preço
SW-ES32	12-24VDC	32 Canais x 1A	12VDC - 384W / 24VDC - 768W	Constant Voltage + SPI (TTL)	170x80x40	93,20 €

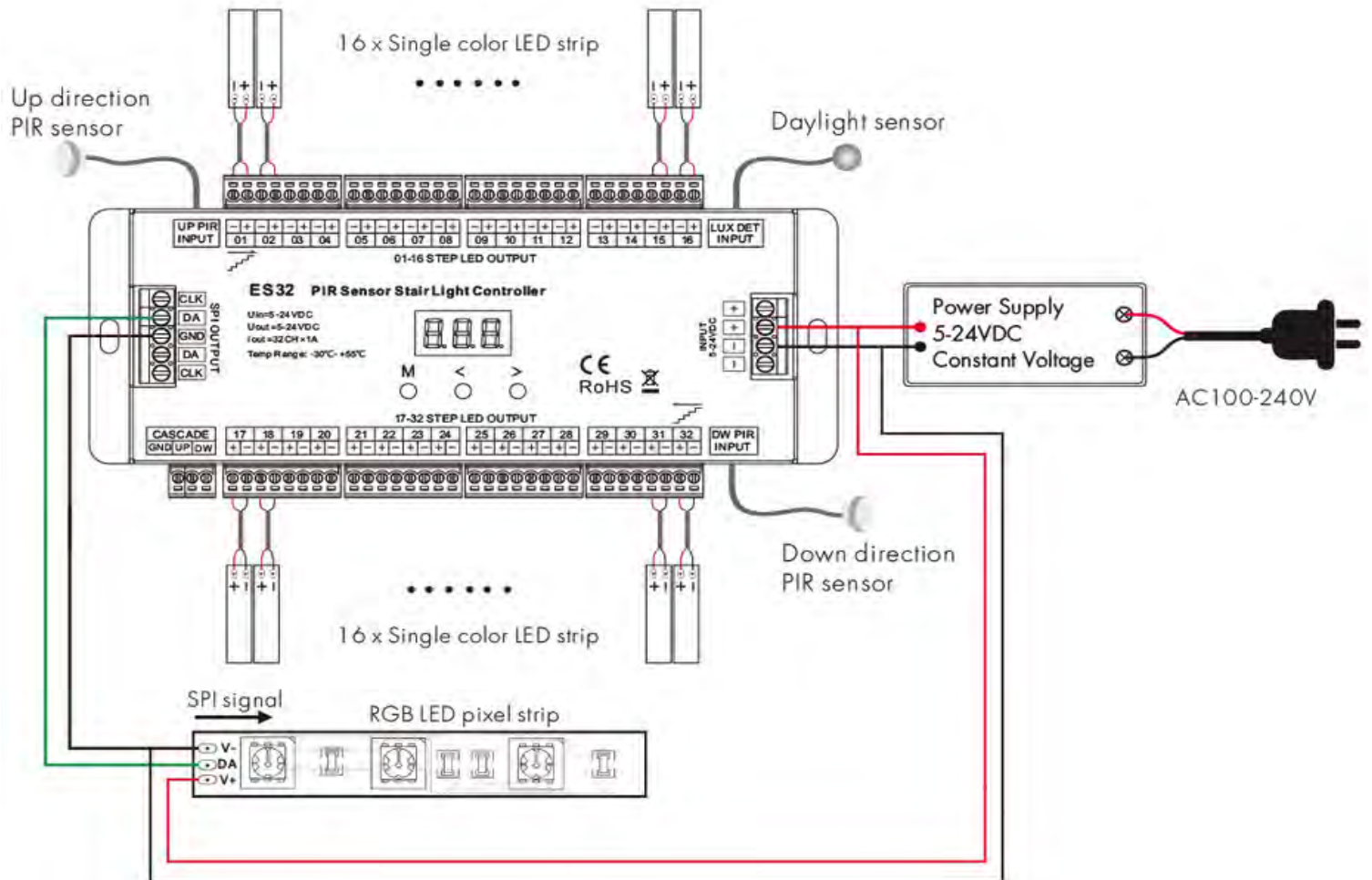

## Sensor Porta ON/OFF 12/24VDC



**Índice de Protecção** IP20

**Temp. Funcionamento** min. -30 max. +55°C

Referencia	Alimentação	Saída	Saída Max.
<b>SR-ADOR</b>	<b>12-24VDC</b>	1 Canal x 8A	12VDC - 96W / 24VDC - 198W

**Protecção** Polaridade Invertida

**Certificado** CE , EMC , LVD

Função	Dimensão	Preço
Controlador para Sensor DIY	97x33x18mm	<b>11,54 €</b>

## Interruptor / Dimmer 12/24VDC

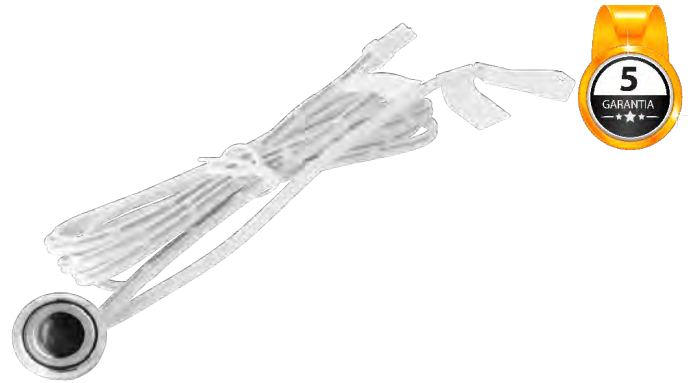
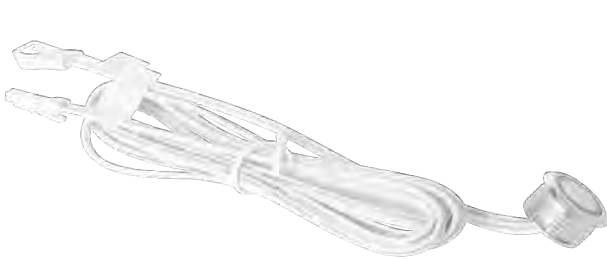

**Índice de Protecção** IP20

**Temp. Funcionamento** min. -30 max. +55°C

Referencia	Alimentação	Saída	Saída Max.
<b>SR-TOD</b>	<b>12-24VDC</b>	1 Canal x 8A	12VDC - 96W / 24VDC - 198W

**Protecção** Polaridade Invertida

**Certificado** CE , EMC , LVD , RED

Função	Dimensão	Preço
Controlador para Sensor DIY	52x52x26mm	<b>11,22 €</b>



# 33 Dimmers



**Especificações técnicas:**

**Obs:** Tamanho standard EU.  
Permite controlo com comando SR-2833S

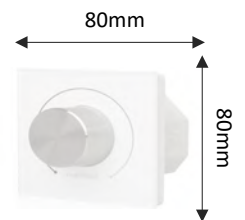

Referencia	Potencia	Volts (ent/saida)	Canais	Sinal Entrada	Push Dim	Função	Dimensão
SR-2400TAC-RF	150W	100-240VAC	1	Dimmer RF TRIAC		DIMMER	80x80x53mm

## Dimmer 12V

Especificações técnicas:

Obs: Ideal para trabalhar com baixa potência, RF de bom alcance, comando tipo porta chaves.

Referencia	Potencia	Volts	Canais	Sinal de Entrada	Material	Dimensão	Preço
521/CH	12VDC / 96W	12VDC	1	RF (2,4GHz)	Plastico	98x57x34mm	7,88 €

## Dimmer 12-24V

Especificações técnicas:

Obs: Comando com 4 Canais, ideal para controlo de iluminação led 5/24VDC, comando pode controlar até 4 zonas diferentes.  
Nota: Kit de 1 controlador + Comando

Referencia	Potencia	Volts	Canais	Sinal de Entrada	Material	Dimensão	Preço
670	12VDC / 192W	5- 24 VDC	1	RF (2,4GHz)	Metal / Plastico	120x67x27mm	19,62 €

## Dimmer 12-24V

Especificações técnicas:

Obs: 1 Canal, ideal para controlo de fitas de led, LED 12/24VDC. Comando à Distancia com varias funções ( Smooth, Fader, Strob, Flash). Nota: Dimensões reduzidas.

Referencia	Potencia	Volts	Canais	Sinal de Entrada	Material	Dimensão	Preço
671	12VDC / 72W	5- 24 VDC	1	RF (2,4GHz)	Metal / Plastico	65x15x10mm	5,40 €

## Comando Dimmer SR

Especificações técnicas:

Obs: Comando 1 canal Touch. Acabamento suave e ergonomico. Compatível com os dimmers ref. **SR-2501**  
Nota: Contem suporte de parede para comando, pilhas incluidas.

Referencia	Zonas	Compatibilidade	Função	Sinal Saida	Alimentação	Dimensão	Preço
SR-2828	1	Toda a Gama SR-2501	DIMMER	RF (2,4GHz)	2 x Pilha CR2025	141x35x8,5mm	20,16 €

## Comando Dimmer SR

Especificações técnicas:

Obs: Comando 1 canal . Acabamento suave e ergonomico. Compatível com os dimmers ref. **SR-2501**  
Nota: Contem suporte de parede para comando, pilhas incluidas

Referencia	Zonas	Compatibilidade	Função	Sinal Saida	Alimentação	Dimensão	Preço
SR-2807N SR-2833S	1	Toda a Gama SR-2501 SR-1009SAC-HP / SR-2400TAC-RF	DIMMER	RF (2,4GHz)	1 x Pilha CR2025	Ø38,5x14mm	12,00 €

## Dimmer SR 12-24V



### Especificações técnicas:

Obs: Permite dimar equipamentos de 12Vdc, através de controlo 0/1-10V. Nota: Compatível com TX211A (Hager); MTN647091 (SCHNEIDER).

Referencia	Potencia	Volts (ent/saída)	Canais	Sinal Entrada	Push Dim	Função	Dimensão	Preço
SR-2006	12VDC / 1'96W	12- 36 VDC	1	0/1-10V	NÃO	DIMMER	95x37x20mm	21,50 €

## Dimmer 230VAC



### Especificações técnicas:

Obs: Permite control através botão pressão (push) ou com comando RF, ref: SR-2801F e SR-2828.  
Nota: Controlador dimmer Push / Comando RF.

Referencia	Potencia	Volts (ent/saída)	Canais	Sinal Entrada	Push Dim	Função	Dimensão	Preço
SR-2501AC	2x 200W	210 - 240 VAC	1	Rádio Frequência	SIM	DIMMER	170x59x29mm	47,00 €

## Dimmer 230VAC



### Especificações técnicas:

Obs: Tamanho standard EU. Permite controlo com comando SR-2833S



Referencia	Potencia	Volts (ent/saída)	Canais	Sinal Entrada	Push Dim	Função	Dimensão	Preço
SR-2400TAC-RF	150W	100-240VAC	1	Dimmer RF TRIAC		DIMMER	80x80x53mm	45,00 €



**Dimmer WIFI TRIAC 230VAC**



⊗ Neutral not required    ⚡ OT, OC, ST protection    ⌚ Min. brightness adjustable    ⌚ Max. brightness self adjust

📄 Power-cut memory and turn-off memory    🧩 Compatible with RC and RL    ⚡ Multiway control

Referencia	Potencia	Volts (ent/saída)	Canais	Sinal Entrada	Push Dim	Função	Dimensão	Preço
VK-D688	150W	100-240VAC	1	Dimmer TRIAC		DIMMER	80x80x53mm	60,00 €
VK-SP	Espelho							4,50 €



# 34 Kinetic Switch



 Sem fios

 Sem Bateria

 Confiável

 3 Anos de Garantia



VKS2-B



VKR1-B



VDB1-B

## Kinetic Switch

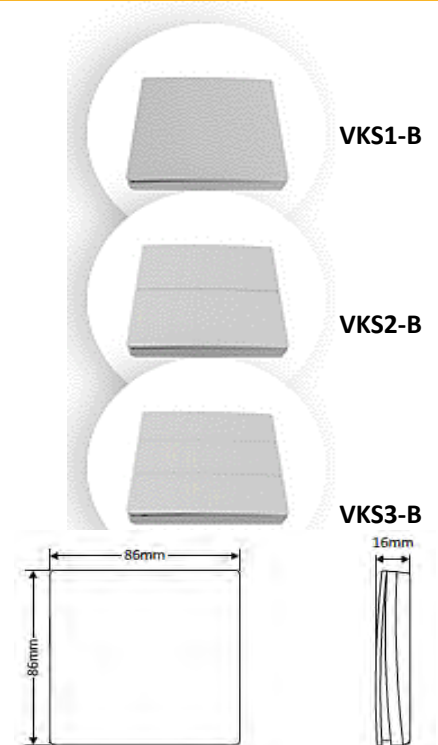

Referencia	RF	Compatibilidade	Função	Material	IP	Preço
VKS1-B						15,27 €
VKS2-B	433Mhz	Recetor Kinetic	On / Off - Dimmer	Polycarbonato	42	17,81 €
VKS3-B						22,73 €

## Kinetic Recetor WIFI 230VAC

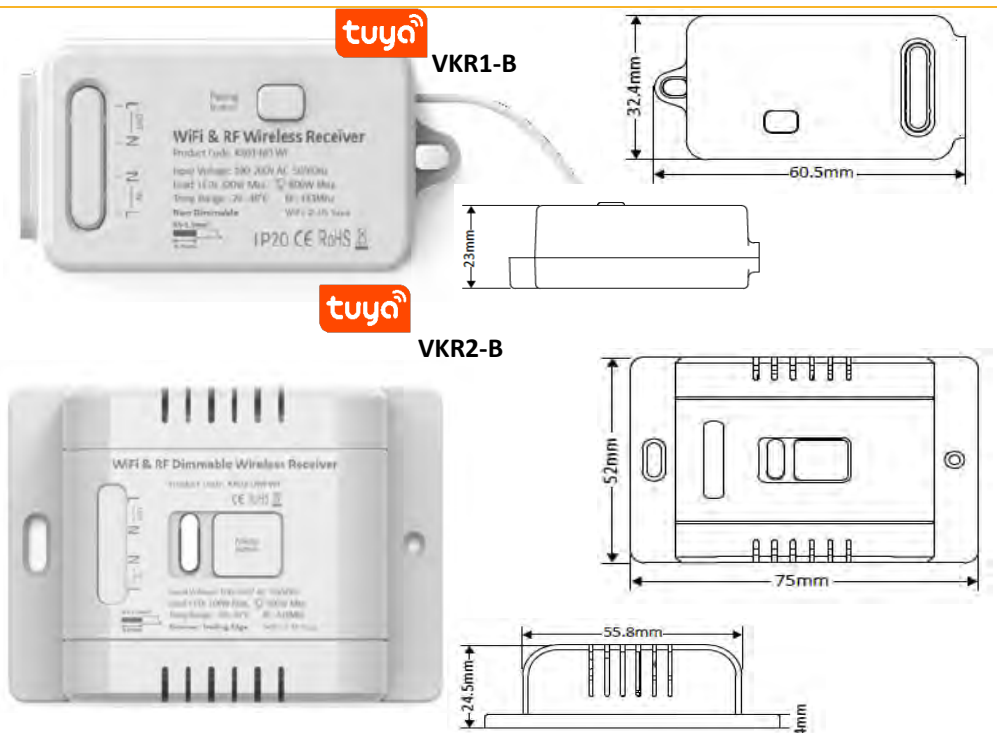

Sinal de Entrada	RF(2,4GHz) - 433Mhz
Alcance	>30 Mt
Compatibilidade	Comandos Kinetic Switch

Temp. Funcionamento	min. -30 max. +55°C
Indice de Protecção	IP20
Certificado	CE , RoHS

Referencia	Alimentação	Saida	Saida Mx.	Função	Preço
VKR1-B			500W	ON/OFF	24,76 €
VKR2-B	85-240V		100W	DIMMER	38,33 €



## Kinetic Recetor WIFI 12 / 24VDC



Sinal de Entrada	RF 433Mhz
Alcance	>35 Mt Exterior; >15Mt Interior
Material	Polycarbonato

Temp. Funcionamento	min. -10 max. +40°C
Indice de Protecção	IP44
Certificado	CE , RoHS

Referencia	Alimentação	Saida	Saida Máx.	Função	Preço
VKR3-B	12-24VDC		12VDC - 60W / 24VDC - 120W	DIMMER	26,38 €

## Kinetic Campainha

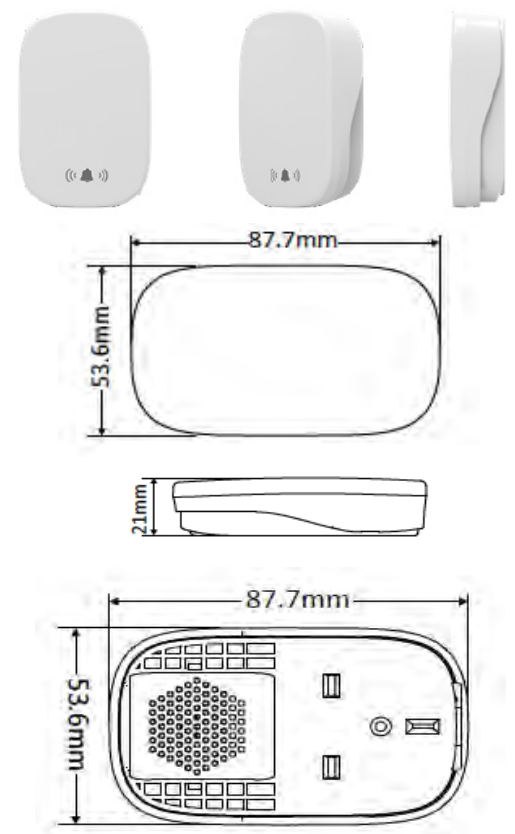

Sinal de Entrada	RF 433Mhz
Alcance	>35 Mt Exterior; >15Mt Interior
Material	Polycarbonato

Temp. Funcionamento	min. -10 max. +40°C
Indice de Protecção	IP44
Certificado	CE , RoHS

Referencia	Alimentação	Função	Preço
VDB1-B	85-240V	Campainha Cinetica	25,09 €

# 35 Amplificadores



Wiring Diagram

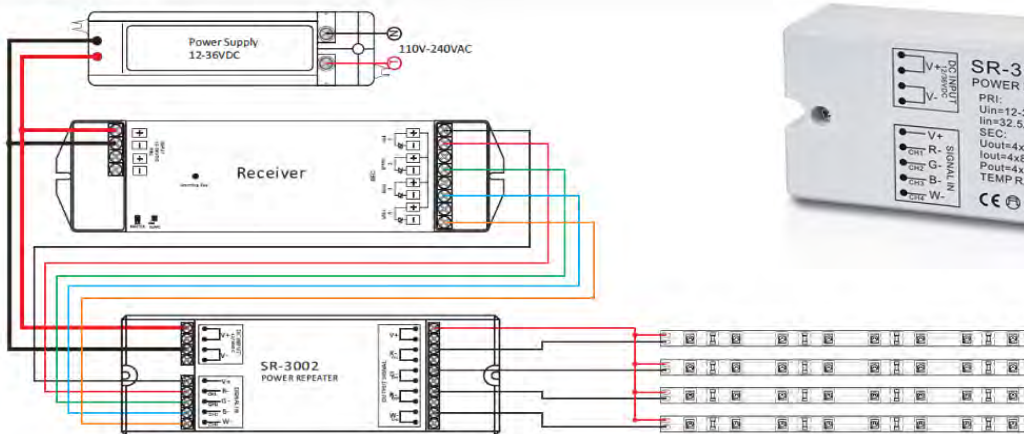

Referencia	Alimentação	Saída	Saída Máx.	Função	Dimensão
SR-3002	12VDC / 4*108W	4 Canais x 8A	12VDC - 384W / 24VDC - 768W	PWM ( 0/1-10V e DMX Decoders)	168x58x28mm

## Amplificador SW RGBW



Sinal de Entrada	PWM e DMX Decoders
Temp. Funcionamento	min. -30 max.+55°C

Certificado	CE, RoHS, EMC, LVD, RED
Índice de Protecção	IP20

Referencia	Alimentação	Saida	Saida Máx.	Função	Dimensão	Preço
SW-EV4	12-24VDC	4 Canais x 5A	12VDC - 240W / 24VDC - 480W	Amplificador de Sinal	175x45x27mm	14,58 €

## Amplificador SR RGBW



Sinal de Entrada	PWM e DMX Decoders
Temp. Funcionamento	min. -20 max.+50°C

Certificado	CE, RoHS, EMC, LVD, TUV
Índice de Protecção	IP20

Referencia	Alimentação	Saida	Saida Máx.	Função	Dimensão	Preço
SR-3002	12VDC / 4*108W	4 Canais x 8A	12VDC - 384W / 24VDC - 768W	PWM ( 0/1-10V e DMX Decoders)	168x58x28mm	29,52 €

## Amplificador RGB / RGBW



Referencia	Alimentação	Saida	Saida Máx.	Função	Dimensão	Preço
529/SM	12-24VDC	3 Canais x 5A	12VDC - 180W / 24VDC - 360W	Amplificador de Sinal	60x34x74mm	8,08 €
529W	12-24VDC	4 Canais x 5A	12VDC - 240W / 24VDC - 480W		147x74x34mm	15,75 €

## Amplificador RGB



Referencia	Alimentação	Saida	Saida Máx.	Função	Dimensão	Preço
324	12-24VDC	3 Canais x 4A	12VDC - 144W / 24VDC - 288W	Amplificador de Sinal	140x65x24mm	6,66 €

# 36 Drives



Obs.: Painel não incluído

Referencia	Potencia	Tensão Entrada	Tensão Saída	Corrente	PF	Dimensão
DRISO/EMC 8/12W	8 - 12w		20 - 42 VDC			92x34x22mm
DRISO/EMC 15/18W	15 - 18w	85 - 265VAC	30 - 63 VDC	300mA	0,5	92x34x22mm
DRISO/EMC 20/24W	20 - 24w		45 - 84 VDC			110x40x24mm

## Drives CC TRIAC Dimmable P/Paineis LED

IP  
20

Referencia	Potencia	Tensão Entrada	Tensão Saída	Corrente	PF	Dimensão	Preço
DRI15/18D	15 - 18w	200 - 265VAC	45 - 60 VDC	300mA	0,9	133x42x30mm	11,87 €
DRI18/22D	18 - 22w		60 - 75 VDC	300mA		160x58x21mm	13,90 €
DRI23/27D	23 - 27w		75 - 90 VDC	300mA		185x64x23mm	15,93 €
DRI39/47D	39 - 48w		70 - 85 VDC	550mA		170x57x33mm	18,72 €

## Drives CC P/Paineis LED

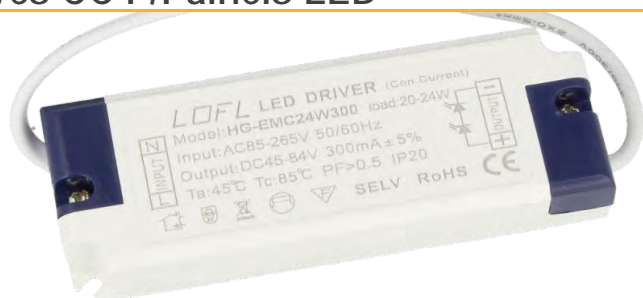
IP  
20

Referencia	Potencia	Tensão Entrada	Tensão Saída	Corrente	PF	Dimensão	Preço
DRISO/EMC 8/12W	8 - 12w	85 - 265VAC	20 - 42 VDC	300mA	0,5	92x34x22mm	3,41 €
DRISO/EMC 15/18W	15 - 18w		30 - 63 VDC			92x34x22mm	3,81 €
DRISO/EMC 20/24W	20 - 24w		45 - 84 VDC			110x40x24mm	4,21 €

## Drives CC

IP  
40

Referencia	Potencia	Tensão Saída	Tensão Entrada	Corrente	Dimensão	Preço
550	6*1 Led	12 - 25 VDC	220 - 240VAC	330mA	40x50x20mm	4,32 €

IP  
40

Referencia	Potencia	Tensão Saída	Tensão Entrada	Corrente	Dimensão	Preço
551	12*1 Led	15 - 30 VDC	220 - 240VAC	420mA	115x47x28mm	7,74 €

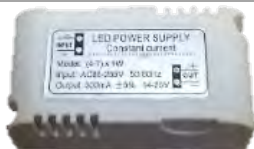
IP  
40

Referencia	Potencia	Tensão Saída	Tensão Entrada	Corrente	Dimensão	Preço
553/7	4 a 7W Led	14 - 28 VDC	220 - 240VAC	300mA	60x30x24mm	4,70 €

## Drives CV

IP  
40

Referencia	Potencia	Tensão Saída	Tensão Entrada	Corrente	Dimensão	Preço
639	24W	12 VDC	110 - 240VAC	2000mA	110x45x28mm	11,25 €
640	27W			2250mA	140x45x28mm	11,70 €



## Drive Dimável 0-10v CC P/Paineis LED 60X60CM / 120X30CM

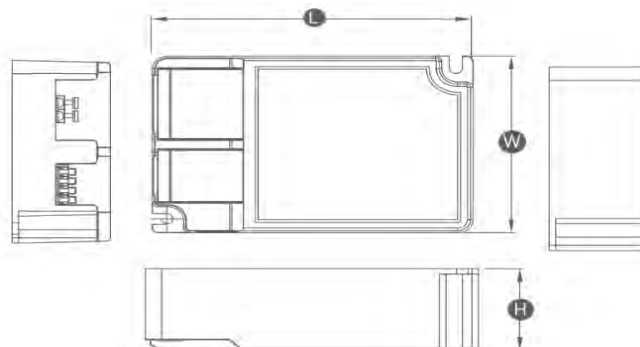

Dimável	0-10v
Output	SELV
Temp. Funcionamento	min. -20 max.+45°C

Protecção	CLASS II
Flicker Free	Pst LM <1,SVM <0,4
Índice de Protecção	IP20

Referencia	Potencia	Tensão Entrada	Tensão Saída	Corrente	PF	Dimensão	Preço
BK-KUL040	40W	180 - 264VAC/DC	24 - 42 VDC	0,60-1,05A	0,95	L103xW68,5xH31	17,96 €

## Drive Dimável DALI CC P/Paineis LED 60X60CM / 120X30CM

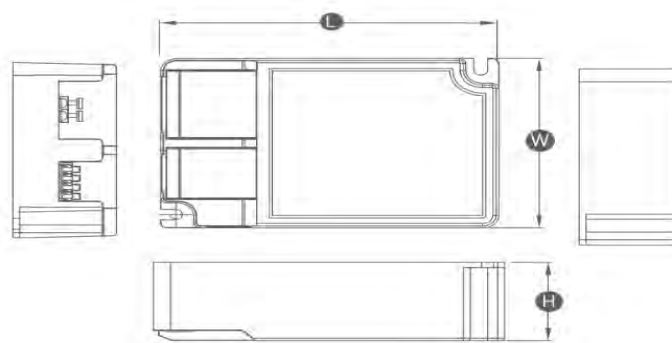

Dimável	DALI
Output	SELV
Temp. Funcionamento	min. -20 max.+45°C

Protecção	CLASS II
Flicker Free	Pst LM <1,SVM <0,4
Índice de Protecção	IP20

Referencia	Potencia	Tensão Entrada	Tensão Saída	Corrente	PF	Dimensão	Preço
BK-DEL042	42W	180 - 264VAC/DC	6 - 42 VDC	0,45-1,10A	0,95	L103xW68,5xH31	27,15 €

## Drive Dimável 0-10v CC P/Paineis LED 60X60CM / 120X30CM



Dimável	0-10v
Output	SELV
Temp. Funcionamento	min. -20 max.+45°C

Protecção	CLASS II
Flicker Free	Pst LM <1,SVM <0,4
Índice de Protecção	IP67

Referencia	Potencia	Tensão Entrada	Tensão Saída	Corrente	PF	Dimensão	Preço
DR-50W-56	50W	100 - 277VAC/DC	30 - 56 VDC	800-1500mA	0,97	L126xW41xH29	16,58 €

# 37 Transformadores

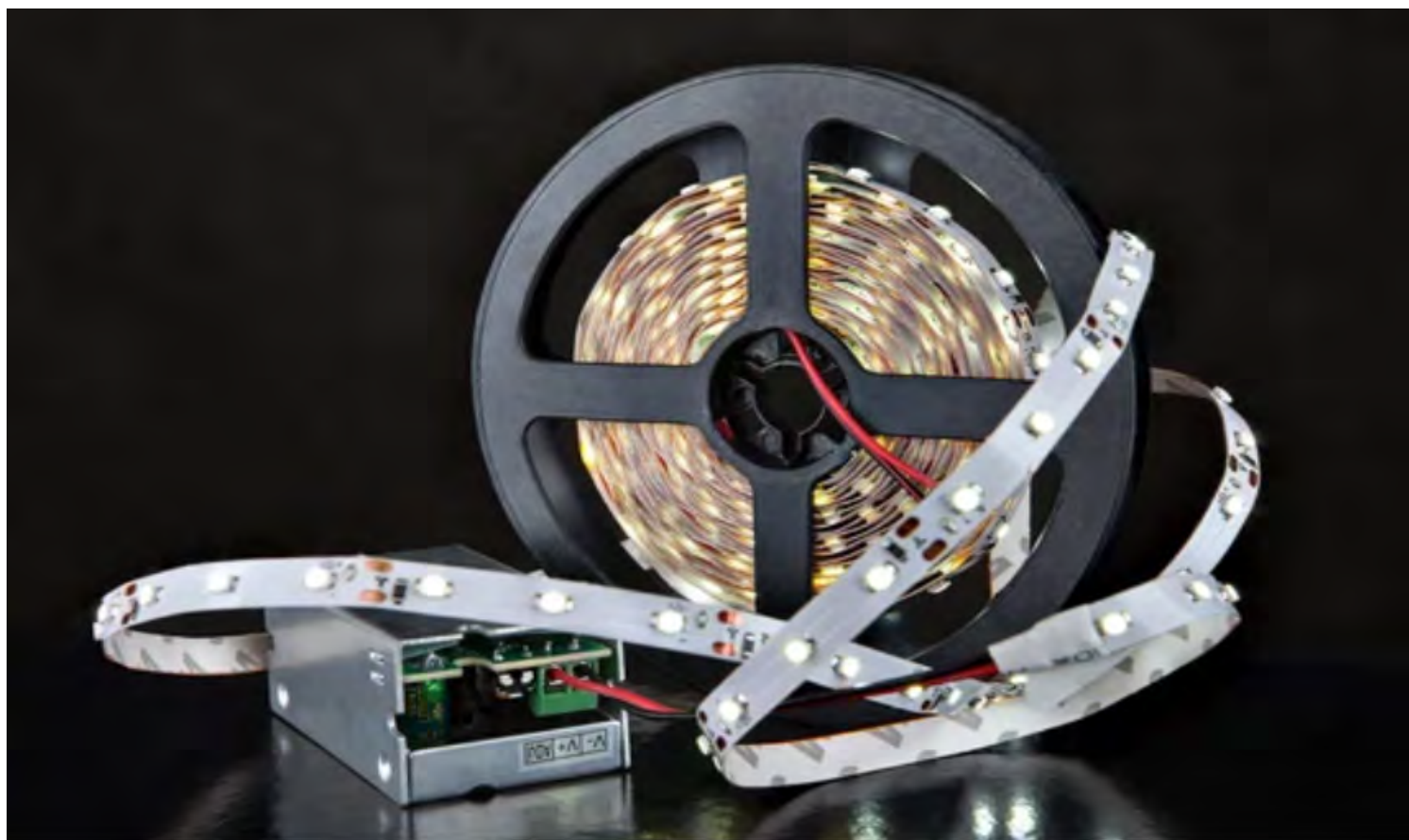



Referencia	Potencia	Tensão Entrada	Tensão Saída	IP	Dimensão
614/300-24	300W	24VDC	170 - 264VAC	IP67	200x72x31mm
614/300		12VDC			

## Transformadores IP20

	Referencia	Potencia	Tensão Saída	Tensão Entrada	Tipo	Dimensão	Preço
	499	12W		210 - 240VAC		96x45x27mm	4,48 €
	500	24W	12 VDC	210 - 240VAC	DeskTop	92x42x28mm	4,57 €
	501	60W		170 - 265VAC		115X57X26mm	7,61 €
	503/45	45W				116x35x23mm	7,88 €
	503/60	60W				142x35x23mm	8,73 €
	503/80	80W				142x35x23mm	10,26 €
	503	100W				138x50x23mm	11,93 €
	503/150	150W		170 - 265VAC		178x50x23mm	14,85 €
	503/200	200W				187x60x28mm	17,00 €
	503/250	250W				187x60x28mm	22,28 €
	503/300	300W				220X60X28mm	49,50 €
	503/400	400W				220X60X28mm	59,00 €
	503/500	500W				235X50X23mm	67,50 €
	518	200W	12 VDC	210 - 240VAC	Perfurado	200X115X50mm	11,25 €
	519/ND	250W		210 - 240VAC		222X68X40mm	16,43 €
	542/A	150W		210 - 240VAC	Slim	208X62X30mm	10,80 €
	518/A	200W		210 - 240VAC	Slim	212X82X30mm	17,10 €
	519/A	250W	12 VDC	210 - 240VAC	Slim	212X82X30mm	19,58 €
	569/A	400W		210 - 240VAC	Slim/Ventilado	218X117X30mm	28,02 €
	517/N	350W		210 - 240VAC	Ventilado	200X110X50mm	19,35 €
	503/45-24	45W				116X35X23mm	7,88 €
	503/60-24	60W				142x35x23mm	8,73 €
	503/80-24	80W				142x35x23mm	10,26 €
	503/100-24	100W				138x50x23mm	11,93 €
	503/150-24	150W		170 - 265VAC		178x50x23mm	14,85 €
	503/200-24	200W	24 VDC		Perfurado	187x60x28mm	17,00 €
	503/250-24	250W				187x60x28mm	22,28 €
	503/300-24	300W				220X60X28mm	49,50 €
	503/400-24	400W				220X60X28mm	59,00 €
	503/500-24	500W				235X50X23mm	67,50 €

## Transformadores IP 67

	527	24W		210 - 240VAC		180x2920mm	6,51 €
	513	30W		210 - 240VAC		204x30x20mm	7,79 €
	614/36	30W		170 - 264VAC		40x25x20,5mm	9,66 €
	614/60	60W		170 - 264VAC		150x38x21mm	10,50 €
	614/75	75W		210 - 240VAC		190x48x34mm	13,88 €
	614/100	100W	12 VDC	170 - 264VAC	IP 67	198x53x19mm	17,00 €
	525	100W		210 - 240VAC		210x71x45mm	17,31 €
	514	150W		210 - 240VAC		235x72x45mm	29,25 €
	498	200W		210 - 240VAC		245x70x43mm	36,00 €
	614/300	300W		170 - 264VAC		220x78x32mm	36,99 €
	614/500	500W		170 - 264VAC		260x78x32	45,05 €
	614/36-24	30W		170 - 264VAC		125x38x21mm	9,66 €
	614/60-24	60W		170 - 264VAC		150x38x21mm	10,50 €
	614/100-24	100W		170 - 264VAC		198x53x19mm	17,00 €
	614/150-24	150W	24 VDC	170 - 264VAC	IP 67	230x132x65mm	29,25 €
	518/24IP	200W		210 - 240VAC		200x115x50mm	36,00 €
	614/300-24	300W		170 - 264VAC		220x78x32mm	36,99 €
	614/500-24	500W		170 - 264VAC		260x78x32	45,05 €

## Transformadores Piscina IP 67



Referencia	Potencia	Tensão Saída	Tensão Entrada	Tipo	Dimensão	Preço
643	80W	12 VAC	210 - 240VAC	IP 67	160x120x95mm	49,47 €
644	150W	12 VAC	210 - 240VAC		177x135x100mm	52,15 €

Obs: Transformador de enrolamentos separados para iluminação de Piscinas.

## Transformadores Dimáveis 0-10V - TRIAC



Referencia	Potencia	Tensão Saída	Tensão Entrada	Tipo	Dimensão	Preço
503/100-12D	100W	12VDC	170 - 264VAC	IP20	140x48x29mm	26,64 €
503/200-12D	200W	12VDC	170 - 264VAC		195x48x29mm	35,52 €
503/100-24D	100W	24VDC	170 - 264VAC	IP20	140x48x29mm	26,64 €
503/200-24D	200W	24VDC	170 - 264VAC		195x48x29mm	35,52 €

## Transformadores Dimáveis DALI



CE RoHS BIS SELV IP67

Referencia	Potencia	Tensão Saída	Tensão Entrada	Tipo	Dimensão	Preço
614/60-24DA	60W	24VDC	100 - 240VAC	IP67	190x51x30mm	49,98 €
614/100-24DA	100W				236x51x30mm	56,83 €
614/200-24DA	200W				284x51x30mm	70,78 €

## Transformadores Voltagem Ajustável

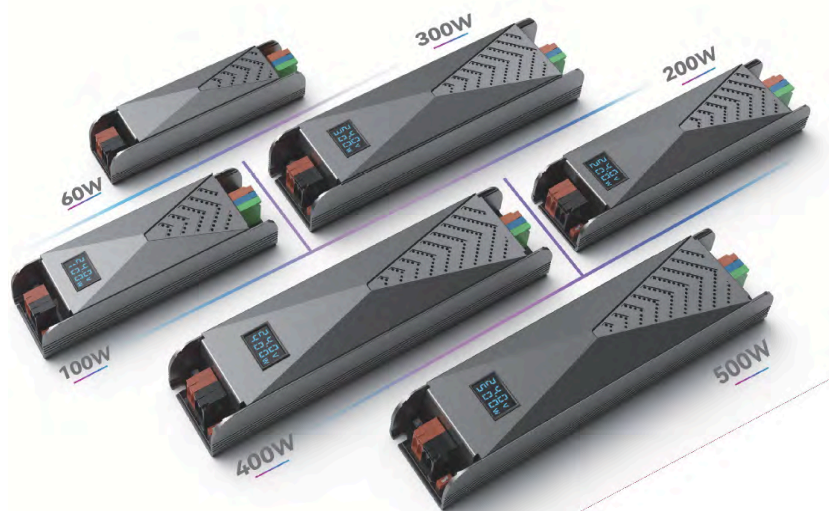

**XT XT Series**

**Innovative Designs**

- | Slow start switch
- | Voltage power display
- | brightness adjustment switch
- | Portable terminal application
- | Integrated glue filling process
- | innovative appearance design

• Integrated glue filling machine, semi-gluing technology

• fully moisture-proof, waterproof, insect-proof, and dust-proof,



































Referencia	Potencia	Tensão Saída	Tensão Entrada	Tipo	Dimensão	Preço
503/60-12XT	60W	12VDC	180 - 265VAC	IP20	157x36,4x28mm	11,61 €
503/100-12XT	100W				171x50,4x28mm	17,00 €
503/200-12XT	200W				207x50,4x28mm	22,58 €
503/500-12XT	500W				254x56,4x34mm	67,50 €
503/60-24XT	60W	24VDC	180 - 265VAC	IP20	157x36,4x28mm	11,61 €
503/100-24XT	100W				171x50,4x28mm	17,00 €
503/200-24XT	200W				207x50,4x28mm	22,58 €
503/500-24XT	500W				254x56,4x34mm	67,50 €



## MEAN WELL GAMA COMPLETA



Os preços dos transformadores Meanwell estão em constante oscilação. Sujeito sempre a confirmação de valor.



	Referencia	Potencia	Tensão Saída	Tensão Entrada	Tipo	Dimensão	Preço
	MW/15	15W	12 VDC	85 ~264VAC	Perfurado	78x51x28mm	11,46 €
	MW/25	25W		85 ~264VAC	Perfurado	78x51x28mm	12,32 €
	MW/35	35W		85 ~264VAC	Perfurado	99x82x30mm	15,12 €
	MW/75	75W		85 ~264VAC	Perfurado	99x97x30mm	21,20 €
	MW/100	100W		85 ~264VAC	Perfurado	129x97x30mm	23,30 €
	MW/150	150W		85 ~264VAC	Perfurado	159x97x30mm	26,90 €
	MW/200	200W		85 ~264VAC	Perfurado	215x115x30mm	63,00 €
	MW/500	500W		85 ~264VAC	Ventilado	230x127x40,5mm	108,90 €
	MW/LPV20-12	20W	12 VDC	90-264VAC	Plástico IP 67	118x35x26mm	12,54 €
	MW/LPV35-12	35W		90-264VAC	Plástico IP 67	148x40x30mm	16,70 €
	MW/LPV60-12	60W		90-264VAC	Plástico IP 67	162x42x30mm	21,10 €
	MW/LPV100-12	100W		90-264VAC	Plástico IP 67	190x52x37mm	31,00 €
	MW/LPV150-12	150W		90-264VAC	Plástico IP 67	191x63x37,5mm	39,60 €
	MW/ELG200-12	200W		100-305VAC	Aluminio IP67	220x71x37,5mm	73,76 €
	MW/ELG300-12	300W		100-305VAC	Aluminio IP67	219x63x35,5mm	107,66 €
	MW/NPF-40	40W	12 VDC	90-305 VAC	Aluminio IP 67	150x53x35mm	32,00 €
	MW/D16	15W	12 VDC	90 ~264VAC	IP42	77x40x29mm	7,98 €
	MW/D25	25W		90 ~264VAC	IP42	84x57x29,5mm	12,40 €
	MW/D35	35W		90 ~264VAC	IP42	84x57x29,5mm	15,50 €
	MW/15-24	15W	24 VDC	85 ~264VAC	Perfurado	62,5x51x28mm	11,60 €
	MW/25-24	25W		85 ~264VAC	Perfurado	78x51x28mm	13,38 €
	MW/35-24	35W		85 ~264VAC	Perfurado	99x82x30mm	14,56 €
	MW/75-24	75W		85 ~264VAC	Perfurado	99x97x30mm	21,20 €
	MW/100-24	100W		85 ~264VAC	Perfurado	129x97x30mm	23,30 €
	MW/150-24	150W		85 ~264VAC	Perfurado	159x97x30mm	24,60 €
	MW/200-24	200W		85 ~264VAC	Perfurado	215x115x30mm	62,80 €
	MW/LPV20-24	20W	24 VDC	90-264VAC	Plástico IP 67	118x35x26mm	13,70 €
	MW/LPV35-24	35W		90-264VAC	Plástico IP 67	148x40x30mm	18,56 €
	MW/LPV60-24	60W		90-264VAC	Plástico IP 67	162x42x30mm	21,10 €
	MW/LPV100-24	100W		90-264VAC	Plástico IP 67	190x52x37mm	33,24 €
	MW/LPV150-24	150W		90-264VAC	Plástico IP 67	191x63x37,5mm	43,80 €
	MW/ELG200-24	200W		100-305VAC	Aluminio IP67	220x71x37,5mm	73,76 €
	MW/ELG300-24	300W		100-305VAC	Aluminio IP67	219x63x35,5mm	107,66 €
	MW/Q60	60W	16 VDC	210-240VAC	Plastico	90x40x102mm	35,00 €
	MW/D8-24	8W	24 VDC	90-305VAC	IP42	162,5x43x32mm	6,06 €



# UHP 350 / 500

- ECO
- Household
- Automata
- Industrial
- Security
- Network
- Telecom
- LED Display

## High Efficiency Slim Power Supply

	Referencia	Potencia	Tensão Saída	Tensão Entrada	Tipo	Dimensão	Preço
	MW/UHP-350-12	350W	12 VDC	90-264VAC	Perfurado	220x62x31mm	111,24 €
	MW/UHP-500-12	500W				232x81x31mm	123,00 €
	MW/UHP-350-24	350W	24 VDC	90-264VAC	Perfurado	220x62x31mm	97,60 €
	MW/UHP-500-24	500W				232x81x31mm	143,00 €

## Transformadores Mean Well Dimáveis



	Referencia	Potencia	Tensão Saída	Tensão Entrada	Tipo	Dimensão	Preço
	MW/LPF60D-12	60W	12VDC	90-305VAC	Aluminio IP67	162,5x43x32mm	34,00 €
	MW/HLG120-12	120W				220x68x38,8mm	49,80 €
	MW/HLG150-12	150W				220x68x38,8mm	61,60 €
	MW/LPF60D-24	60W	24VDC	90-305VAC	Aluminio IP67	162,5x43x32mm	34,00 €
	MW/HLG100-24	100W				220x68x38,8mm	54,20 €
	MW/HLG150-24	150W				220x68x38,8mm	61,60 €

# 39 Track Lights



Referencia	Cor	Potencia	Tensão Entrada	Tensão Saída	IP	Dimensão
SW-D70P	PRETO	20 W	2020	3000K ou 4000K	200-240VAC	L250 x ø70mm
SW-D70B	BRANCO					
SW-D70ACR	Opalino			Acrílico compatível com SW-D70		

## TRACK LIGHTS

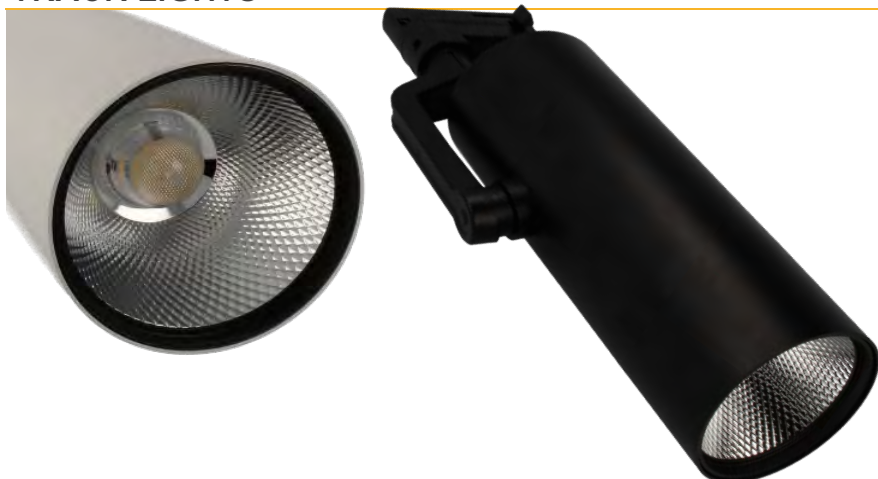
Especificações técnicas:

Material: Alumínio + Reflector  
 Tempo de vida: 50.000H Led  
 Cobertura: Vidro

**LIFUD** EPISTAR  
 LED Driver



24°  
 IP 22  
 FP 0,90  
 CRI >85

Referencia	COR	Potencia	Lumens	Temp. Cor	Voltagem	Base	Dimensão	Preço
224/30WP-4	PRETO	30 W	3000	3000K ou 4000K	200-240VAC	Calha Trifásica	L215 x ø90mm	53,78 €
224/30WB-4	BRANCO							

## TRACK LIGHTS

Especificações técnicas:

Material: Alumínio + Reflector  
 Tempo de vida: 50.000H Led  
 Cobertura: Vidro

**LIFUD** EPISTAR  
 LED Driver



24°  
 IP 22  
 FP 0,90  
 CRI >85

Referencia	COR	Potencia	Lumens	Temp. Cor	Voltagem	Base	Dimensão	Preço
211/3P	PRETO	30 W	3000	3000K ou 4000K	200-240VAC	Calha Trifásica	L215 x ø90mm	51,35 €
211/3B	BRANCO							

## TRACK LIGHTS

Especificações técnicas:

Material: Alumínio + Reflector  
 Tempo de vida: 30.000H Led  
 Tipo drive: Interno

**EPISTAR**

38°  
 IP 40  
 FP 0,90  
 CRI >85

Referencia	COR	Potencia	Lumens	Temp. Cor	Voltagem	Base	Dimensão	Preço
230/PWB	PRETO	30 W	2 700	4000K	85 - 250VAC	Calha Trifásica	L236 x ø110mm	56,00 €



## TRACK LIGHTS ZOOMABLE





LED	Luminus-CXM 9
Material	1070 Pure Aluminium
CRI	90

Temp. Funcionamento	min. -10 max.+35°C
Angulo de Abertura	20° - 55°
IP	20

Referencia	COR	Potencia	Lumens	Temp. Cor	Voltagem	Base	Dimensão	Preço
SW-ZP8-4 SW-ZB8-4	PRETO BRANCO	8W	720	3000K-4000K	200 - 250VAC	Calha Trifásica	L135 x ø50mm	35,01 €
SW-ZP24-4 SW-ZB24-4	PRETO BRANCO	24 W	2 350	3000K-4000K	200 - 250VAC	Calha Trifásica	L172 x ø73mm	49,47 €

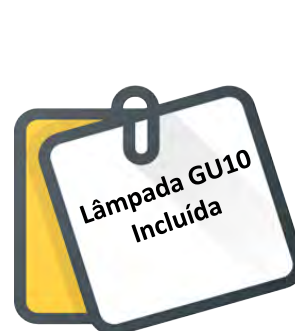
## TRACK LIGHTS



LED	GU10
Material	1070 Pure Aluminium

Temp. Funcionamento	min. -10 max.+35°C
IP	20

Referencia	COR	Potencia	Lumens	Temp. Cor	Voltagem	Base	Dimensão	Preço
SW-SD201-P SW-SD201-B	PRETO BRANCO			3000K / 6000K	200 - 250VAC	Calha Trifásica	L135 x ø65mm	16,68 €

## Luminária Suspensa 20W

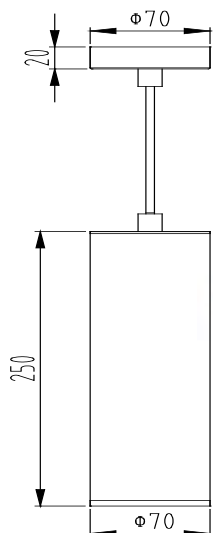

LED	Luminus-CXM 4
LED Current	500mA
CRI	90

Temp. Funcionamento	min. -10 max.+35°C
Angulo de Abertura	35°
IP	20

Referencia	CÓR	Potencia	Lumens	Temp. Cor	Voltagem	Dimensão	Preço
SW-D70P	PRETO	20 W	2020	3000K ou 4000K	200-240VAC	L250 x ø70mm	43,13 €
SW-D70B	BRANCO						

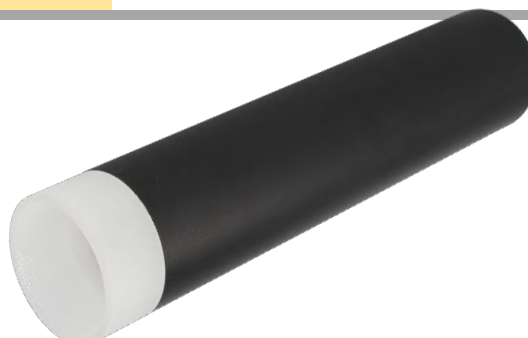

Referencia	COR	Descrição	Preço
SW-D70ACR	Opalino	Acrilico compativel com SW-D70	2,86 €

## Calha Track Light



Referencia	Acessorio	nº Fios	Cor	Dimensão	Preço
226/1	Calha Saliente	4	Branco	1Mt.	21,31 €
226/1B	Calha Saliente	4	Preto		
226/2	Calha Saliente	4	Branco	2Mt.	35,88 €
226/2B	Calha Saliente	4	Preto		

## Conectores

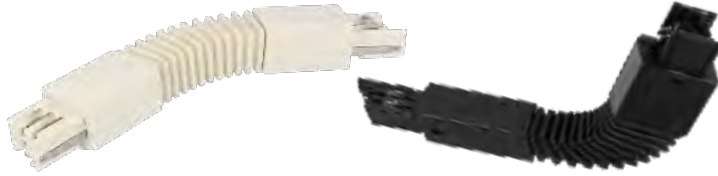

Referencia	Cor	Preço
227/FLEXB	Branco	8,40 €
227/FLEXP	Preto	

Acessorio	nº Fios	Material
Conector flexivel	4	Plástico



Referencia	Cor	Preço
227/L	Branco	7,10 €
227/LB	Preto	

Acessorio	nº Fios	Material
Conector em L	4	Plástico



Referencia	Cor	Preço
227/T	Branco	12,23 €
227/TB	Preto	

Acessorio	nº Fios	Material
Conector em T	4	Plástico



Referencia	Cor	Preço
227/X	Branco	12,23 €

Acessorio	nº Fios	Material
Conector em X	4	Plástico



Referencia	Cor	Preço
227/I	Branco	12,23 €
227/IB	Preto	

Acessorio	nº Fios	Material
Conector em I	4	Plástico



Referencia	Cor	Preço
228/2PC	Branco	2,79 €
228/2PCB	Preto	

Acessorio	nº Fios	Material
Conector em I	4	Plástico



Referencia	Cor	Preço
228/PC	Branco	2,79 €
228/PCB	Preto	

Acessorio	nº Fios	Material
Conector de ligação	4	Plástico



Referencia	Cor	Preço
228/CAP	Branco	0,60 €
228/CAPB	Preto	

Acessorio	nº Fios	Material
Topo final de calha	4	Plástico

# 40 Conectores - Conversores



**FIO/RGB**

**FIO/RGB-6-3**

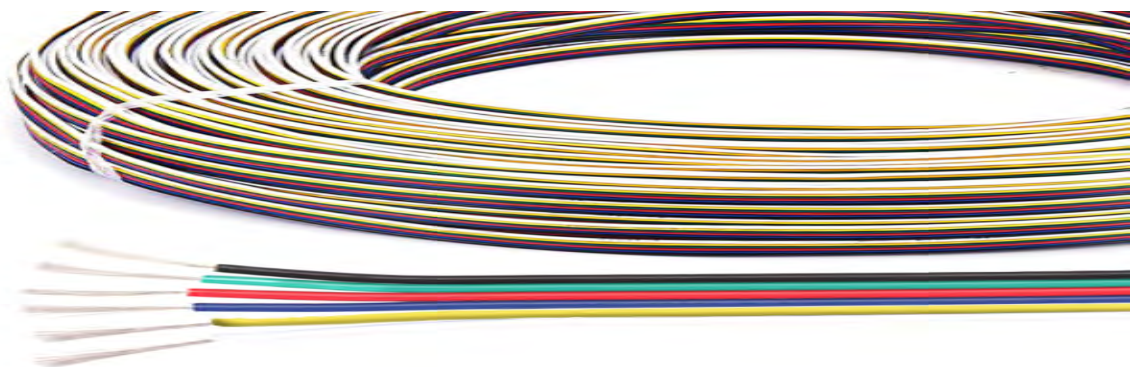

Referencia	Características
FIO/RGB	Cabo 4 cores espalmado 4x0,50mm, para fitas RGB - Preço de venda Bobine 100Mt.
FIO/RGB-6-3	Cabo 6 cores espalmado 5x0,50mm, para fitas RGB+W / WW

## Conectores

Referencia	Características	Preço
	T8/1S Conector T8 de um lado	0,60 €
	509/WP Conector 2 fios (3,5mm) Macho - Femea, resistente á agua	0,86 €
Referencia	Características	Preço
	511 Conector 2 fios Macho - Femea, Fita simples, resistente á agua	1,00 €
	512 Conector 4 fios Macho - Femea, Fita simples, resistente á agua	Obs: Preço conjunto Macho - Femea
Referencia	Características	Preço
	610 Conetor 2 fios, macho - femea Fita simples	0,80 €
	617 Conector rápido, para fita 8mm, ligação a transformador por "jack"	0,80 €
	618 Conector rápido, para fita 10mm, ligação a transformador por "jack"	Obs: Preço de venda unitário
Referencia	Características	Preço
	590 Conector rápido, c/ 10 cm de fio 2x0,50mm para fita 8mm,	0,60 €
	591 Conector rápido, c/ 10 cm de fio 2x0,50mm para fita 10mm.	Obs: Preço de venda unitário
Referencia	Características	Preço
	592 Conector rápido, 4 fios para fita RGB 10mm.	0,60 €
	Obs: Ligador 4 x0,50mm colorido, para fita RGB	Obs: Preço de venda unitário
Referencia	Características	Preço
	590/L União de conector rápido, para fita simples de 8mm.	0,50 €
	591/L União de conector rápido, para fita simples de 10mm .	Obs: Preço de venda unitário
Referencia	Características	Preço
	592/L União conector rápido, 4 fios para fita RGB 10mm.	0,50 €
		Obs: Preço de venda unitário
Referencia	Características	Preço
	594 Casquilho Cerâmica GU10 S/ repicagem	0,50 €
		Obs: Preço de venda unitário

## Casquilho GU10 s/repique

## Fio de 2 Condutores

Referencia	Caracteristicas	Preço
 FIO/2L	Cabo de 2 Condutores	0,60 €

Obs: Preço de venda ao metro

## Fio RGB

Referencia	Caracteristicas	Preço
 FIO/RGB	Cabo 4 cores espalmado 4x0,50mm, para fitas RGB	44,40 €

Obs: Preço de venda Bobine 100Mt.

## Fio RGB+W

Referencia	Caracteristicas	Preço
 FIO/RGB-6	Cabo 5 cores espalmado 4x0,50mm, para fitas RGB+W	1,00 €

Obs: Preço de venda ao metro

## Fio RGB+W / WW

Referencia	Caracteristicas	Preço
 FIO/RGB-6-3	Cabo 6 cores espalmado 5x0,50mm, para fitas RGB+W / WW	1,17 €

Obs: Preço de venda ao metro

## Conversores

	Referencia	Caracteristicas	Preço
	560	Conversor GU10 / E27	1,17 €
			<small>Obs: Preço de venda unitário</small>
	Referencia	Caracteristicas	Preço
	561	Conversor E27 / GU10	1,24 €
			<small>Obs: Preço de venda unitário</small>
	Referencia	Caracteristicas	Preço
	593	Conversor E14 / GU10	1,24 €
			<small>Obs: Preço de venda unitário</small>
	Referencia	Caracteristicas	Preço
	562	Conversor E14 / E27	1,24 €
			<small>Obs: Preço de venda unitário</small>
	Referencia	Caracteristicas	Preço
	563	Conversor E27 / E14	1,24 €
			<small>Obs: Preço de venda unitário</small>
	Referencia	Caracteristicas	Preço
	564	Conversor E27 / 2xE27	1,62 €
			<small>Obs: Preço de venda unitário</small>
	Referencia	Caracteristicas	Preço
	613	Conversor E27 / E40	1,90 €
			<small>Obs: Preço de venda unitário</small>
	Referencia	Caracteristicas	Preço
	613/E40	Conversor E40 / E27	1,90 €
			<small>Obs: Preço de venda unitário</small>

# 41 Perfil



Referencia	Caracteristicas	Dimensoes Exterior	Dimensoes Interior
777/26	PERFIL ANODIZADO COM DIFUSOR OPALINO	15,2x29,46mm	12,16m



## Perfil para Fita Led

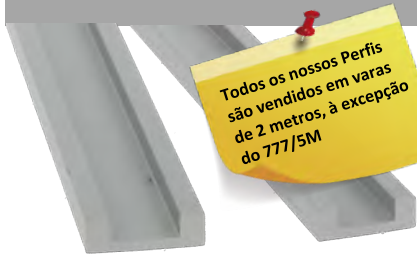

Referência	Difusor	Preço/Mt
777	Sem Difusor	1,68 €
Dimensões Exterior		Dimensões Interior
17x7mm		10,5mm
Aluminio	Difusor	Superfície
6063-T5	PMMA	Anodizada

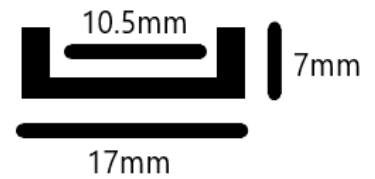

Referência	Difusor	Preço/Mt
777/2	Opalino	2,73 €
777/2TP	Transparente	
Dimensões Exterior		Dimensões Interior
16x16mm		10mm
Aluminio	Difusor	Superfície
6063-T5	PMMA	Anodizada

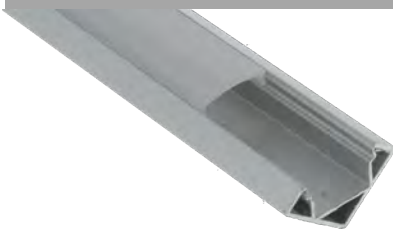
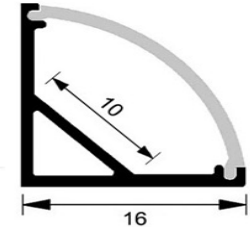

Referência	Difusor	Preço/Mt
777/3	Opalino	2,73 €
Dimensões Exterior		Dimensões Interior
18,5x18,5mm		12,2mm
Aluminio	Difusor	Superfície
6063-T5	PMMA	Anodizada

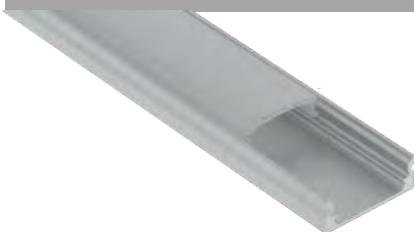
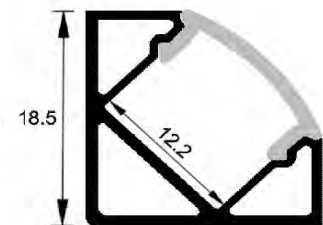

Referência	Difusor	Preço/Mt
777/4	Opalino	1,85 €
777/4TP	Transparente	
Dimensões Exterior		Dimensões Interior
17,5x7mm		12,2mm
Aluminio	Difusor	Superfície
6063-T5	PMMA	Anodizada

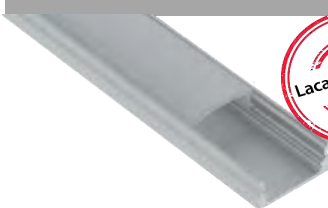
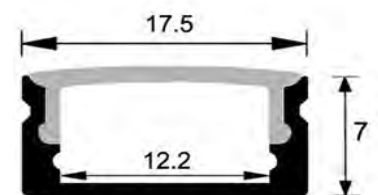

Referência	Difusor	Preço
777/4B	Opalino	2,25 €
Dimensões Exterior		Dimensões Interior
17,5x7mm		12,2mm
Aluminio	Difusor	Superfície
6063-T5	PMMA	Anodizada

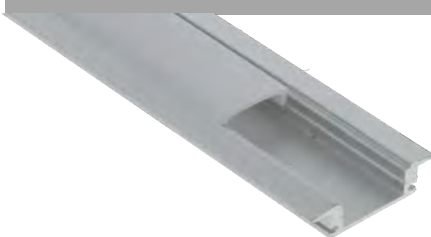
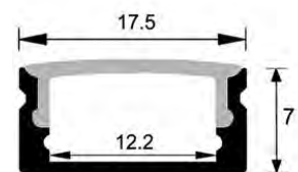

Referência	Difusor	Preço/Mt
777/5	Opalino	2,08 €
777/5TP	Transparente	
Dimensões Exterior		Dimensões Interior
24,5x7mm		12,2mm
Aluminio	Difusor	Superfície
6063-T5	PMMA	Anodizada

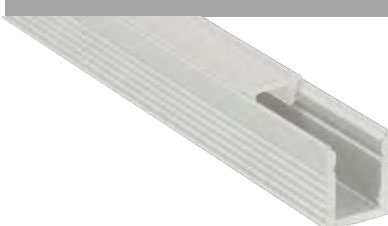
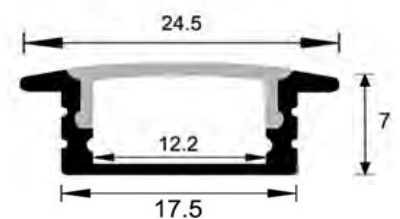



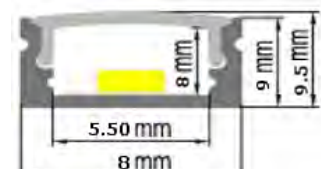

Referência	Difusor	Preço/Mt
777/5M	Opalino	4,41 €
Dimensões Exterior		Dimensões Interior
8x9,5mm		5,5mm
Aluminio	Difusor	Superfície
6063-T5	PMMA	Anodizada

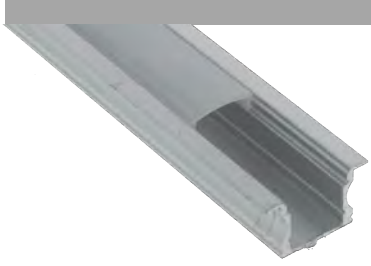
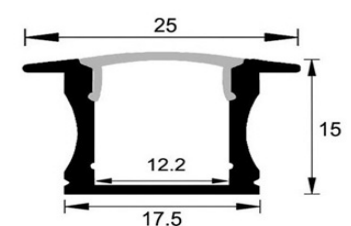

Nota: O Perfil 777/5M é vendido em varas de 1MT

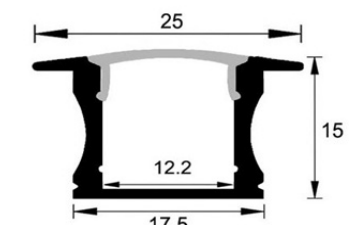
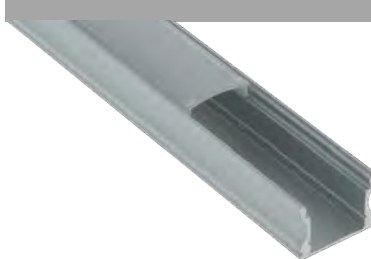
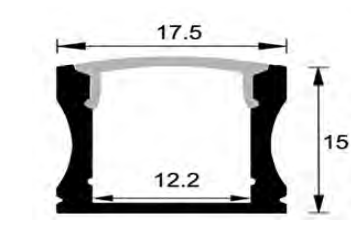
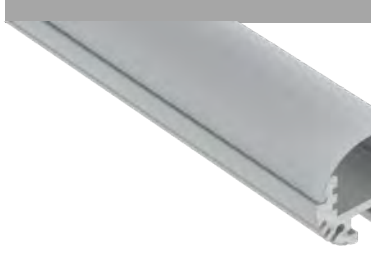
## Perfil para Fita Led

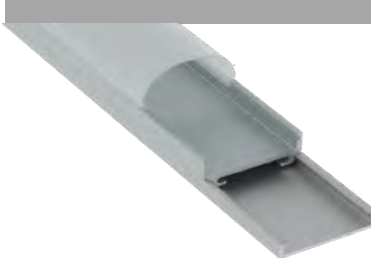
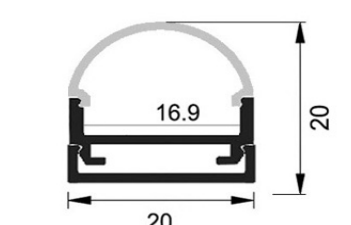
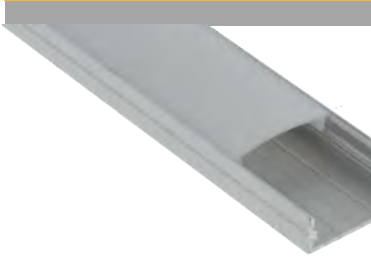
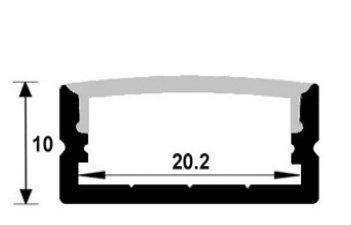
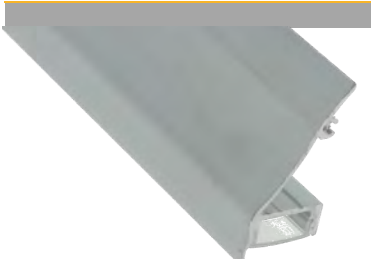
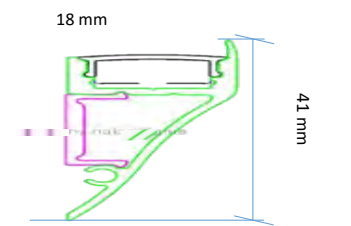
	Referência	Difusor	Preço/Mt	
	777/6	Opalino	2,62 €	
	777/6TP	Transparente		
	Dimensões Exterior	Dimensões Interior		
24,5x15mm	12,2mm			
Aluminio	Difusor	Superfície		
6063-T5	PMMA	Anodizada		
	Referência	Difusor	Preço/Mt	
	777/6B	Opalino	2,77 €	
	777/6BTP	Transparente		
	Dimensões Exterior	Dimensões Interior		
24,5x15mm	12,2mm			
Aluminio	Difusor	Superfície		
6063-T5	PMMA	Lacado Branco		
	Referência	Difusor	Preço/Mt	
	777/7	Opalino	2,08 €	
	777/7TP	Transparente		
	Dimensões Exterior	Dimensões Interior		
17,5x15mm	12,2mm			
Aluminio	Difusor	Superfície		
6063-T5	PMMA	Anodizada		
	Referência	Difusor	Preço/Mt	
	777/8	Opalino	6,37 €	
	777/8TP	Transparente		
	Dimensões Exterior	Dimensões Interior		
20,8mm	12,2mm			
Aluminio	Difusor	Superfície		
6063-T5	PMMA	Anodizada		
	Referência	Difusor	Preço/Mt	
	777/9	Opalino	5,19 €	
	777/9TP	Transparente		
	Dimensões Exterior	Dimensões Interior		
20x20mm	16,8mm			
Aluminio	Difusor	Superfície		
6063-T5	PMMA	Anodizada		
	Referência	Difusor	Preço/Mt	
	777/11	Opalino	3,01 €	
	777/11TP	Transparente		
	Dimensões Exterior	Dimensões Interior		
23x10mm	20,2mm			
Aluminio	Difusor	Superfície		
6063-T5	PMMA	Anodizada		
	Referência	Difusor	Preço	
	777/13	Opalino	7,08 €	
	777/13TP	Transparente		
	Dimensões Exterior	Dimensões Interior		
18x41mm	12,2mm			
Aluminio	Difusor	Superfície		
6063-T5	PMMA	Anodizada		

## Perfil para Fita Led



Referência	Difusor	Preço/Mt
777/15	Opalino	14,87 €

Dimensões Exterior	Dimensões Interior
--------------------	--------------------

54x34mm	31,54mm
---------	---------

Aluminio	Difusor	Superfície
----------	---------	------------

6063-T5	PMMA	Anodizada
---------	------	-----------

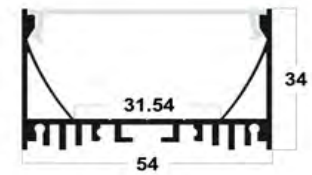

Referência	Difusor	Preço/Mt
777/16	Opalino	17,53 €

Dimensões Exterior	Dimensões Interior
--------------------	--------------------

64,88x36mm	39,68mm
------------	---------

Aluminio	Difusor	Superfície
----------	---------	------------

6063-T5	PMMA	Anodizada
---------	------	-----------

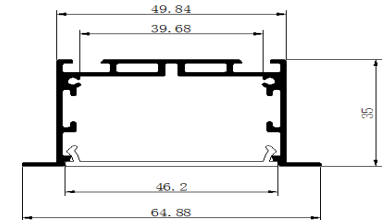

Referência	Difusor	Preço/Mt
777/16B	Opalino	18,29 €

Dimensões Exterior	Dimensões Interior
--------------------	--------------------

64,88x36mm	39,68mm
------------	---------

Aluminio	Difusor	Superfície
----------	---------	------------

6063-T5	PMMA	Lacado Branco
---------	------	---------------

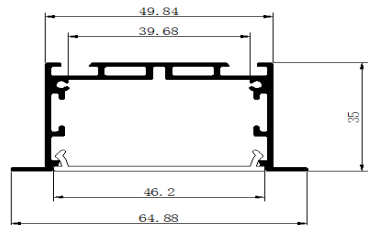

Obs: Para Fita 5mm

Referência	Difusor	Preço/Mt
777/18	Opalino	5,07 €

Dimensões Exterior	Dimensões Interior
--------------------	--------------------

25x11mm	12,7mm
---------	--------

Aluminio	Difusor	Superfície
----------	---------	------------

6063-T5	PMMA	Anodizada
---------	------	-----------

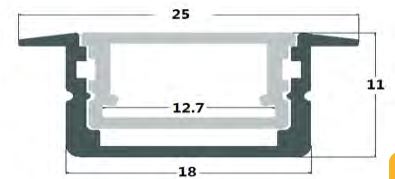
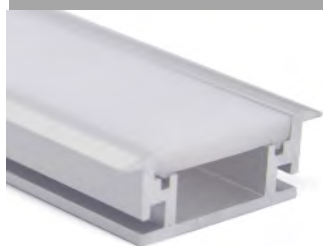
IP  
67

Referência	Difusor	Preço/Mt
777/19	Opalino	7,10 €

Dimensões Exterior	Dimensões Interior
--------------------	--------------------

27,1x11mm	12,2mm
-----------	--------

Aluminio	Difusor	Superfície
----------	---------	------------

6063-T5	PMMA	Anodizada
---------	------	-----------

IP  
67

Referência	Difusor	Preço/Mt
777/20	Opalino	7,05 €

Dimensões Exterior	Dimensões Interior
--------------------	--------------------





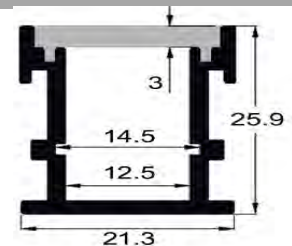

21,3x25,9mm	12,5mm
-------------	--------

Aluminio	Difusor	Superfície
----------	---------	------------

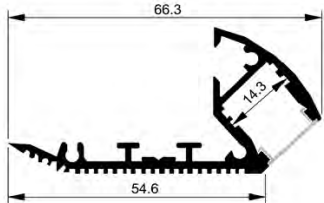
6063-T5	PMMA	Anodizada
---------	------	-----------

IP  
67

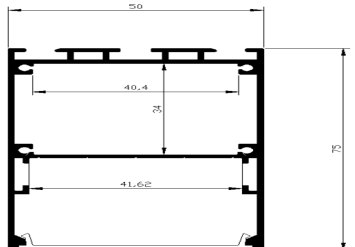
## Perfil para Fita Led

	Referência	Difusor	Preço/Mt	
	777/21	Opalino	8,21 €	
	Dimensões Exterior	Dimensões Interior		
	54,6x66,3mm	14,3mm		
Alumínio	Difusor	Superfície		
6063-T5	PMMA	Anodizada		
Referência	Difusor	Preço/Mt		
	777/22	Opalino	4,00 €	
	Dimensões Exterior	Dimensões Interior		
	29,7x29,7mm	20,55mm		
	Alumínio	Difusor	Superfície	
6063-T5	PMMA	Anodizada		
Referência	Difusor	Preço/Mt		
	777/23	Opalino	6,34 €	
	Dimensões Exterior	Dimensões Interior		
	20,3x27mm	17,1mm		
	Alumínio	Difusor	Superfície	
6063-T5	PMMA	Anodizada		
Referência	Difusor	Preço/Mt		
	777/24	Opalino	8,50 €	
	Dimensões Exterior	Dimensões Interior		
	24x19mm	12,6mm		
	Alumínio	Difusor	Superfície	
6063-T5	PMMA	Anodizada		
Referência	Difusor	Preço/Mt		
	777/25	Opalino	22,60 €	
	Dimensões Exterior	Dimensões Interior		
	50x75mm	40,4mm		
	Alumínio	Difusor	Superfície	
6063-T5	PMMA	Anodizada		
Referência	Difusor	Preço/Mt		
	777/26	Opalino	10,40 €	
	Dimensões Exterior	Dimensões Interior		
	15,2x29,46mm	12,16mm		
	Alumínio	Difusor	Superfície	
6063-T5	PMMA	Anodizada		
Referência	Difusor	Preço/Mt		
	777/27	Opalino	1,35 €	
	Dimensões Exterior	Dimensões Interior		
	18x6mm	13mm		
	Alumínio	Difusor	Superfície	
6063-T5	PMMA	Anodizada		

Perfil para  
Roupeiros

Perfil Flexível

## Perfil para Fita Led

Referência	Difusor	Preço/Mt
777/28	Opalino	5,27 €
Dimensões Exterior	Dimensões Interior	
61,4x14mm	20,66mm	
Aluminio	Difusor	Superfície
6063-T5	PMMA	Anodizada



Referência	Difusor	Preço/Mt
777/29	Opalino	5,61 €
Dimensões Exterior	Dimensões Interior	
56x15mm	12,5mm	
Aluminio	Difusor	Superfície
6063-T5	PMMA	Anodizada



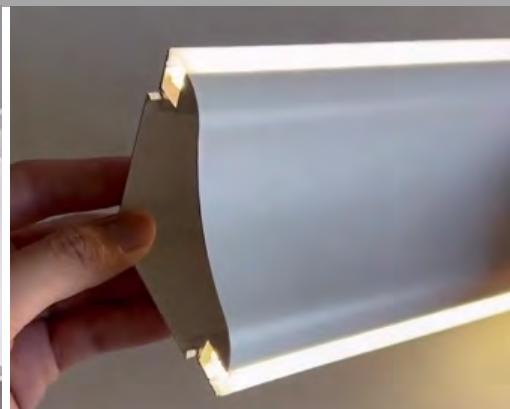

Referência	Difusor	Preço/Mt
777/30B	Opalino	11,70 €
Dimensões Exterior	Dimensões Interior	
69x69mm	12,5mm	
Aluminio	Difusor	Superfície
6063-T5	PMMA	Lacado Branco





## Acessórios para perfil

Referencia	Características	Preço
SUSP/PER	Kit de suspensão para perfil de linhas contínuas	
SUSP/PER 1	Kit de suspensão para perfil de linhas contínuas 777/22 e 777/23	3,00 €
SUSP/PER 2	Kit de suspensão para perfil de linhas contínuas 777/25	

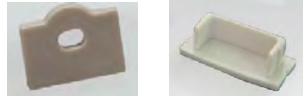

Referencia	Características	Preço
778	Topos para perfil Topos para perfil em plástico de encaixe. O topo deve ser escolhido para o respetivo perfil. Todos os topos utilizam a mesma referência.	0,60 €



Referencia	Características	Preço
778/1	Fixadores p/perfil Fixadores para perfil em plástico de encaixe. O fixador deve ser escolhido para o respetivo perfil. Todos os fixadores utilizam a mesma referência.	0,60 €



## Perfil para Fita Led



Referência	Difusor	Preço
777/NE1616	Opalino	4,46 €

Dimensões Exterior	Dimensões PCB
16x16mm	12mm
Difusor	Material
Branco	Silicone

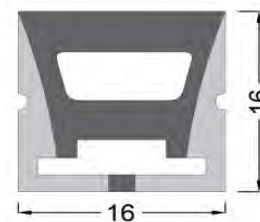

Referência	Difusor	Preço
777/NE1616P	Opalino	8,47 €

Dimensões Exterior	Dimensões PCB
16x16mm	12mm
Difusor	Material
Preto	Silicone

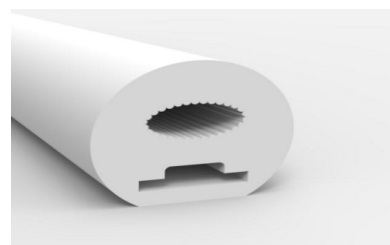
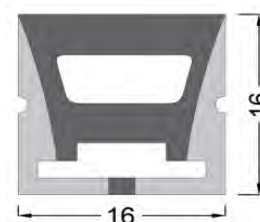

Referência	Difusor	Preço
777/NED20	Opalino	8,17 €

Dimensões Exterior	Dimensões PCB
20mm	10mm
Difusor	Material
Branco	Silicone



## Acessórios para Perfil de Neon



Referência	Características	Preço
TP-NE1616	Topos para o Perfil de Neon 777/NE1616	0,60 €



TP-NE1616P	Topos para o Perfil de Neon 777/NE1616P	0,60 €
------------	---	--------



TP-NED20	Topos para o Perfil de Neon 777/NED20	0,63 €
----------	---------------------------------------	--------



FP-NE1616	Fixadores para o Perfil de Neon 777/NE1616	0,63 €
-----------	--	--------



FP-NE1616P	Fixadores para o Perfil de Neon 777/NE1616P	0,63 €
------------	---	--------



FP-NED20	Fixadores para o Perfil de Neon 777/NED20	0,27 €
----------	---	--------



# 42 Linear Led



Referencia	Potencia	Lumens	Temp. Cor	Corte	Dimensão	Preço Não Dimável	Preço Dimável 0-10V
LN703560-4E	20W	1800	4000K	605x60x60mm	C616xA35xL70mm		
LN703512-4E	40W	3600	4000K	1200x60x60mm	C1211xA35xL70mm		
LN703518-4E	60W	5400	4000K	1800x60x60mm	C1805xA35xL70mm		
LN703524-4E	80W	7200	4000K	2390x60x60mm	C2400xA35xL70mm		

## Linear Suspenso

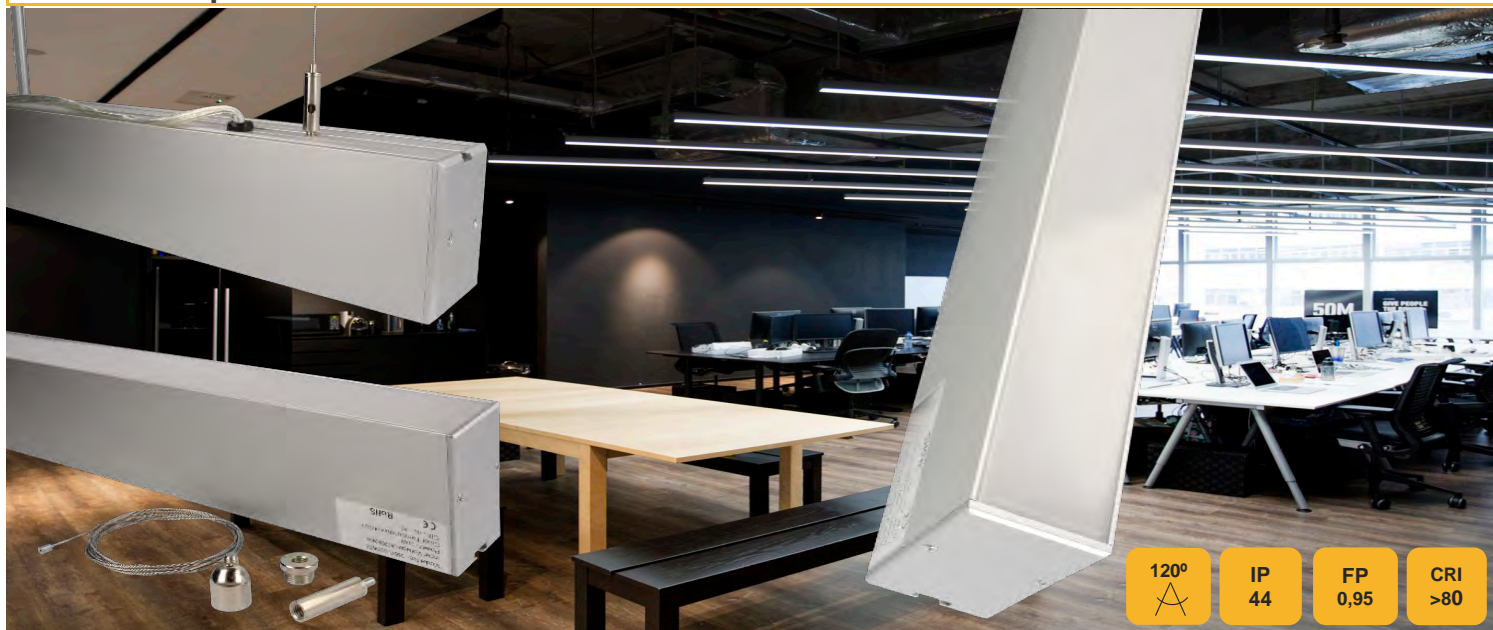

Referencia	Potencia	Lumens	Temp. Cor	Voltagem	Dimensão	Preço	Dimável 0-10V
LN356760-4	20W	1800	4000K	200-240VAC	C600xA35xL67mm	42,88 €	57,62 €
LN557560-4					C600xA55xL75mm	51,25 €	65,99 €
LN356712-4	40W	3600	4000K	200-240VAC	C1200xA35xL67mm	67,48 €	83,10 €
LN557512-4					C1200xA55xL75mm	92,09 €	107,71 €
LN356718-4	60W	5400	4000K	200-240VAC	C1800xA35xL67mm	93,62 €	114,74 €
LN557518-4					C1800xA55xL75mm	111,12 €	132,24 €
LN356724-4	80W	7200	4000K	200-240VAC	C2400xA35xL67mm	120,51 €	146,47 €
LN557524-4					C2400xA55xL75mm	142,33 €	168,29 €

## Linear de Encastrar

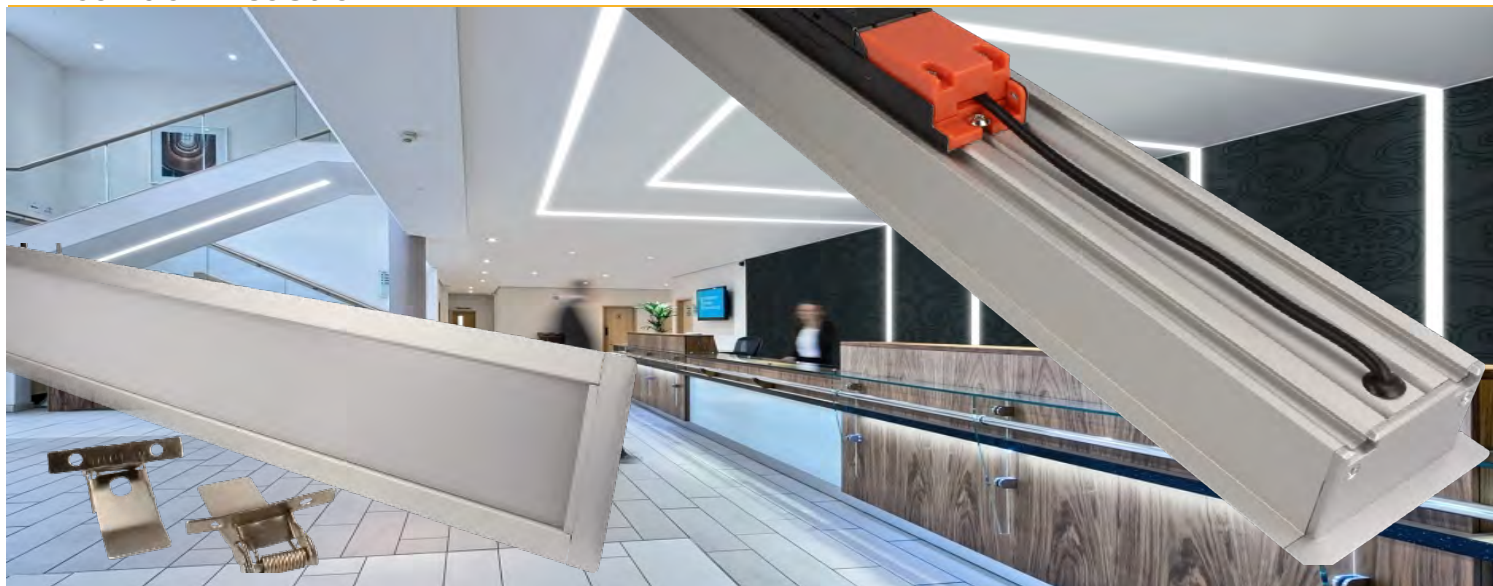

Referencia	Potencia	Lumens	Temp. Cor	Corte	Dimensão	Preço	Dimável 0-10V
LN703560-4E	20W	1800	4000K	605x60x60mm		51,25 €	65,99 €
LN703512-4E	40W	3600	4000K	1200x60x60mm	C1211xA35xL70mm	63,17 €	78,79 €
LN703518-4E	60W	5400	4000K	1800x60x60mm	C1805xA35xL70mm	94,38 €	115,50 €
LN703524-4E	80W	7200	4000K	2390x60x60mm	C2400xA35xL70mm	125,58 €	151,54 €



## Acessórios para Linear

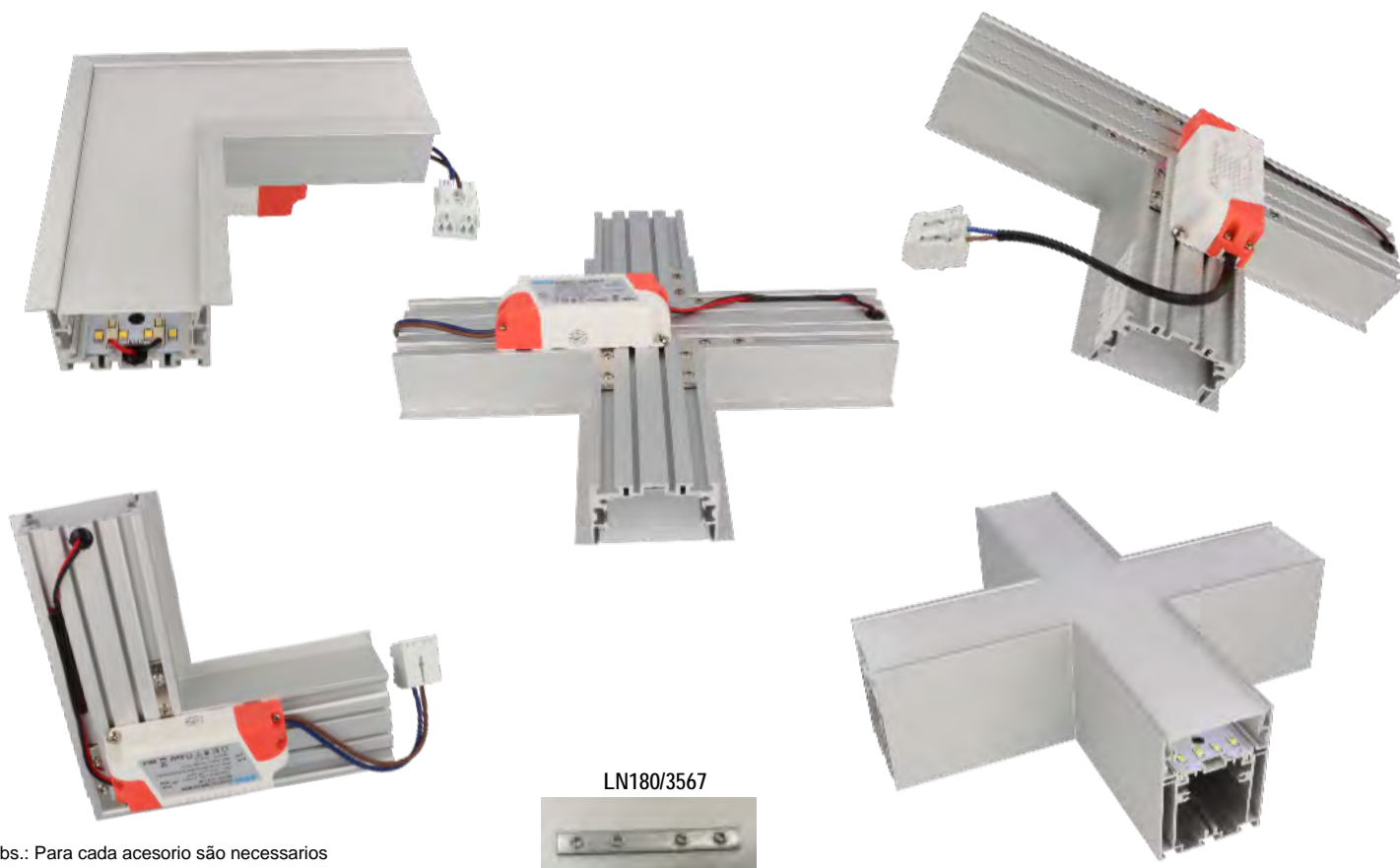

Obs.: Para cada acesorio são necessarios conectores de ligação.

Referencia	Acessorio	Caracteristicas	Cor	Dimensões	Preço
LNT/5575	Conector em T	Suspenso	4000K	100X100X100mm	49,22 €
LNL/5575	Conector em L	Suspenso	4000K	100X100mm	40,08 €
LNX/5575	Conector em X	Suspenso	4000K	100X100mm	57,08 €
LNT/7035	Conector em T	Encastrar	4000K	100X100X100mm	45,67 €
LNL/7035	Conector em L	Encastrar	4000K	100X100mm	40,08 €
LNX/7035	Conector em X	Encastrar	4000K	100X100mm	55,31 €
LN180/3567	CONEXÃO 180°				1,00 €

120°

IP  
44FP  
0,95CRI  
>80

# 42 LedTube DIY

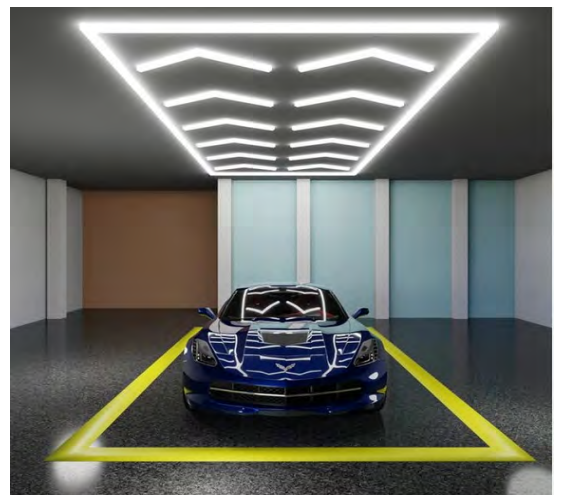
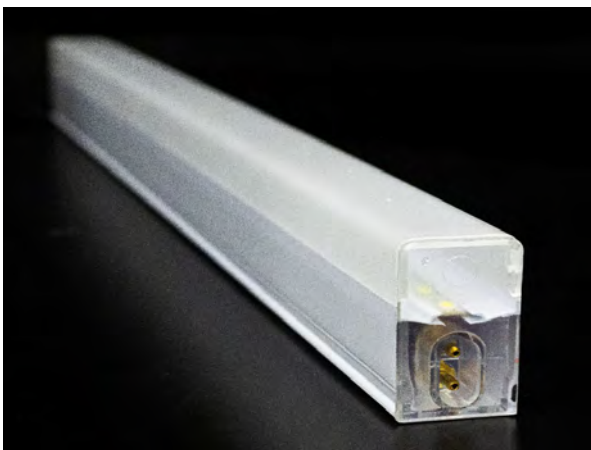

Referencia	COR	Potencia	Lumens	Temp. Cor	Voltagem	Dimensão
TL/44-6	Branco	7W		6000K	200-240VAC	440mm*20mm

## LedTube DIY

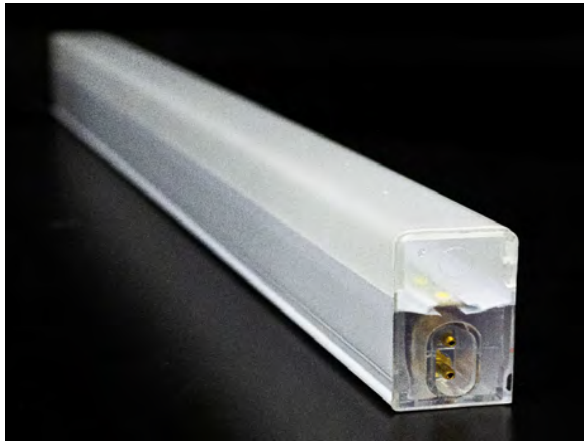

Referencia	COR	Potencia	Lumens	Temp. Cor	Voltagem	Dimensão	Preço
TL/44-6	Branco	7W	700	6000K	200-240VAC	440mm*20mm	5,38 €

## Conectores para LedTube DIY



Referencia	Cor	Preço
TL/PC	Transparente	2,03 €

Acessorio	Material
Cabo Conector	Plástico



Referencia	Cor	Preço
TL/CV	Transparente	1,60 €

Acessorio	Material
Conector em V	Plástico



Referencia	Cor	Preço
TL/CY	Transparente	1,60 €

Acessorio	Material
Conector em Y	Plástico



Referencia	Cor	Preço
TL/CI	Transparente	1,60 €

Acessorio	Material
Conector em I	Plástico



Referencia	Cor	Preço
TL/CT	Transparente	1,60 €

Acessorio	Material
Conector em T	Plástico



Referencia	Cor	Preço
TL/NC		1,60 €

Acessorio	Material
Cabo de Nylon	Nylon



Referencia	Cor	Preço
TL/SUSP		1,60 €

Acessorio	Material
Kit de Suspensao	Cabo de Aço

# 43 Modulos Led



Referencia	Potencia	Lumens	Temp. Cor
LM/3636-RGB	0,72W		<b>R</b> <b>G</b> <b>B</b>
Voltagem	IP	Dimensão	
12VDC	65	36*36MM	



## Modulos de Led IP68



Referencia	Potencia	Lumens	Temp. Cor
615/3	1,2W	115	3000K

Voltagem	IP	Dimensão	Preço
12VDC	68	79x14mm	1,32 €

## Modulos de Led IP68



Referencia	Potencia	Lumens	Temp. Cor
616/4	0,72W	123	4000K

Voltagem	IP	Dimensão	Preço
12VDC	68	52X12mm	1,40 €

## Modulos de Led

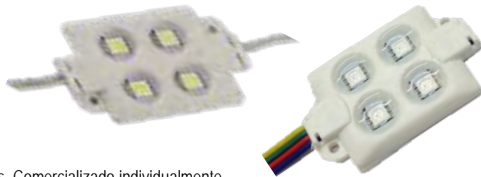

Obs: Séries de 20 módulos. Comercializado individualmente.

Referencia	Potencia	Lumens	Temp. Cor	Voltagem	Base	Dimensão	Dimensão
615/WN	2W	150	6000K	12 VDC	Modulo	35x55mm	0,86 €
615/RGB		R-76; G-23; B-4 Nm	<span style="color:red">R</span> <span style="color:green">G</span> <span style="color:blue">B</span>	12 VDC	Modulo	35x55mm	1,04 €

## Especificações técnicas:

Material:	Plástico
Tempo de vida:	30.000H Led
Cobertura	Plástico
Tipo de Led:	SMD 5050
Quant. Leds:	4

120°

IP  
54FP  
0,6CRI  
>80

Obs: Séries de 20 módulos. Comercializado individualmente.

Referencia	Potencia	Lumens	Temp. Cor	Voltagem	Base	Dimensão	Preço
616/WN4	2,4W	220	6000K	12 VDC	Modulo	35x55mm	0,99 €

## Especificações técnicas:

Material:	Alumínio
Tempo de vida:	30.000H Led
Cobertura	Plástico
Tipo de Led:	SMD 5630
Quant. Leds:	3/4

## Modulos de Led IP68



Referencia	Potencia	Lumens	Temp. Cor
LM/8016-6	1,5W	210	6000K

Voltagem	IP	Dimensão	Preço
12VDC	67	80x16mm	0,83 €

## Modulos de Led IP68



Referencia	Potencia	Lumens	Temp. Cor
LM/3636-RGB	0,72W	66	<span style="color:red">R</span> <span style="color:green">G</span> <span style="color:blue">B</span>

Voltagem	IP	Dimensão	Preço
12VDC	65	36X36mm	1,00 €

## Modulos de Led IP68



Referencia	Potencia	Lumens	Temp. Cor
LM/3636-3	2W	240	6000K

Voltagem	IP	Dimensão	Preço
12VDC	67	36X36mm	0,70 €

# 44 Diversos Led



Referencia	Potencia	Lumens	Temp. Cor	Voltagem	Base	IP	Dimensão
098/N830	1,5W	140	3000K	85 - 265VAC	E 14	40	Ø23x51mm
098/N840		140	4000K				

## Led Diversos

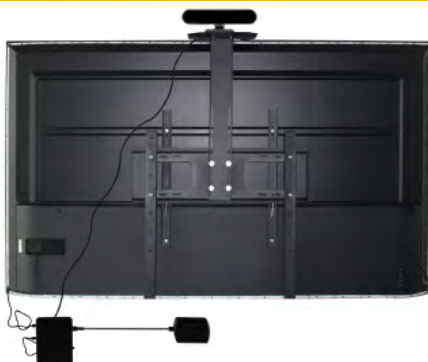

Adaptador	USB+TypeC+TypeA
Camera Pixel	300,000
Tamanho Camera	166x72x50

Controlo	App + Control Box
Conexão	Wi-Fi + Bluetooth
Certificado	CE , RoHS

Referencia	Potencia	Voltagem	CCT	Led's	Preço
STVCAM	6,5W	12V	R G B	30/mt	53,28 €

## Led Diversos



### Especificações técnicas:

Material:	Plástico
Tempo de vida:	30.000H Led
Equivalencia	10W Incandescente
Cobertura	Plástico/Transparente
Tipo de Led:	SMD 3014
Quant. Leds:	37
Tipo drive:	Interno

360°

IP  
40FP  
0,60CRI  
>80

Referencia	Potencia	Lumens	Temp. Cor	Voltagem	Base	Dimensão	Preço
198/W	5W	460	6000K	85 - 265VAC	E 14	Ø18x65mm	6,34 €
198/WW		410	3000K				

## Led Diversos



### Especificações técnicas:

Material:	Plástico
Tempo de vida:	30.000H Led
Equivalencia	10W Incandescente
Cobertura	Plástico/Transparente
Tipo de Led:	SMD 2835
Quant. Leds:	33
Tipo drive:	Interno

360°

IP  
40FP  
0,60CRI  
>80

Referencia	Potencia	Lumens	Temp. Cor	Voltagem	Base	Dimensão	Preço
098/N830	1,5W	140	3000K	85 - 265VAC	E 14	Ø23x51mm	3,12 €
098/N840		140	4000K				

## GX53



### Especificações técnicas:

Material:	Aluminio
Tempo de vida:	30.000H Led
Equivalencia	25W Incandescente
Cobertura	Plástico/Transparente
Tipo de Led:	SMD 2835
Quant. Leds:	40
Tipo drive:	Interno

360°

IP  
40FP  
0,60CRI  
>80

Referencia	Potencia	Lumens	Temp. Cor	Voltagem	Base	Dimensão	Preço
179+	8W	800	6000K	85 - 265VAC	GX 5.3	Ø75x27mm	11,16 €
180+		720	3000K	85 - 265VAC	GX 5.3	Ø75x27mm	

## PL 2G11



### Especificações técnicas:

Material:	Alumínio / Plástico
Tempo de vida:	30.000H Led
Base	2 G11
Cobertura	Plástico
Tipo de Led:	2835
Quant. Leds:	60/76/120/168
Tipo drive:	Interno

120°  
IP  
40FP  
0,95CRI  
>80

Referencia	Potencia	Lumens	Temp. Cor	Voltagem	Equivalencia	Dimensão	Preço
074/8N	8W	850	4000K	85 - 265VAC	ECO 18W	43mm x230mm	8,17 €
074/12N	12W	1 020	4000K	85 - 265VAC	ECO 25W	37mm x 320mm	9,64 €
074/18N	18W	1 530	4000K	85 - 265VAC	ECO 36W	37mm x 410mm	11,42 €
074/22N	22W	1 980	4000K	85 - 265VAC	ECO 55W	37mm x 535mm	14,61 €

## PL 2G10



### Especificações técnicas:

Material:	
Tempo de vida:	30.000H Led
Base	2 G10
Cobertura	Plástico
Tipo de Led:	2835

120°  
IP  
40FP  
0,95CRI  
>80

Referencia	Potencia	Lumens	Temp. Cor	Voltagem	Equivalencia	Dimensão	Preço
2G1012W	12W		2700	85 - 265VAC	ECO 25W	85x126mm	20,50 €

## G12



### Especificações técnicas:

Material:	Ceramica
Tempo de vida:	30.000H Led
Equivalencia	HQI 70W
Cobertura	Não
Tipo de Led:	SMD 2835
Quant. Leds:	108
Tipo drive:	Interno

360°  
IP  
20FP  
0,90CRI  
>80

Referencia	Potencia	Lumens	Temp. Cor	Voltagem	Base	Dimensão	Preço
128/WN	10W	1200	6000K	200 - 240 VAC	G 12	ø26x100mm	8,89 €
128/WWN		1100	3000K	200 - 240 VAC	G 12	ø26x100mm	

## T8 Circular



### Especificações técnicas:

Material:	Alumínio
Tempo de vida:	30.000H Led
Cobertura	Não
Tipo de Led:	SMD 5630
Quant. Leds:	18/24
Tipo drive:	Externo

120°  
IP  
20FP  
0,6CRI  
>80

Referencia	Potencia	Lumens	Temp. Cor	Voltagem	Base	Dimensão	Preço
204/W	9W	720	6000K	220-240VAC	Circular	Ø210mm	13,95 €

## Barras de led



### Especificações técnicas:

Material:	Aluminio / Resina
Tempo de vida:	30.000H Led
Cobertura	Resina
Tipo de Led:	SMD 5050
Quant. Leds:	36/60
Tipo drive:	Direto

120°  
IP  
20FP  
0,6CRI  
>80

Referencia	Potencia	Lumens	Temp. Cor	Voltagem	Base	Dimensão	Preço
111	7,6W	600	12000	12 VDC	Barra	600x17x10mm	10,00 €
112	14,4W	1 000	12000	12 VDC	Barra	1000x17x10mm	15,00 €

Obs: As barras 111/112 devido a temperatura de cor são indicadas para colocação em aquários.



L  
O  
F  
L

# CANDEEIRO



2  
0  
2  
4

## Candeeiros com Bateria IP54

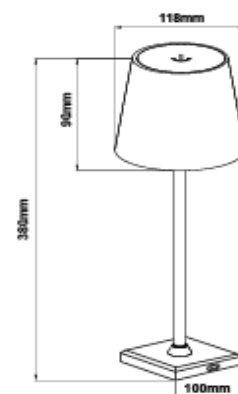

Change the CCT by touch switch

Referencia	Potencia	Lumens/Mt.	Côr	Angulo	Working Time	Material	Dimensão	Preço
T118-B T118-P	3,5W	270	Branco Preto	100	10 ~ 15H	Alu + PMMA	118 x 380	30,19 €

## Candeeiros com Bateria IP54



Referencia	Potencia	Lumens/Mt.	Côr	Angulo	Working Time	Material	Dimensão	Preço
T140-B T140-P	3,5W	220	Branco Preto	100	10 ~ 15H	Alu + PMMA	118 x 380	22,93 €

## Candeeiros Suspensos



Referencia	Potencia	Temp. Cor	Composição	Dimensão	Preço
PL170856-4	44W	4000K	Fita de Led 24v	550X540mm	79,80 €



Referencia	Potencia	Temp. Cor	Composição	Dimensão	Preço
PL170617-4	60W	4000K	Fita de Led 24v	1200X305mm	73,50 €



Referencia	Potencia	Temp. Cor	Composição	Dimensão	Preço
L99141-4	18W	4000K	Fita de Led 24v		58,80 € 187

## Candeeiros Suspensos



Referencia	Acabamento	Composição	Dimensão	Preço
PL170803A-E27	Gold	E27	250X600X1200mm	27,30 €

OBS.: Lâmpada E27 não incluída



Referencia	Acabamento	Composição	Dimensão	Preço
CTSE27-LD180	Bronze /Silver	E27	D360mm	39,48 €

OBS.: Lâmpada E27 não incluída



Referencia	Acabamento	Composição	Dimensão	Preço
CTSE27-LD38	Branco/ Ferro	E27	320*160mm	17,85 € <sup>188</sup>

OBS.: Lâmpada E27 não incluída

## Candeeiros Suspensos



Referencia	Acabamento	Composição	Dimensão	Preço
CTSE27-LD25	Ferro	E27	300X270mm	22,05 €

OBS.: Lâmpada E27 não incluída



Referencia	Acabamento	Composição	Dimensão	Preço
L99859-E27	Preto	E27	300X1200mm	21,00 €

OBS.: Lâmpada E27 não incluída

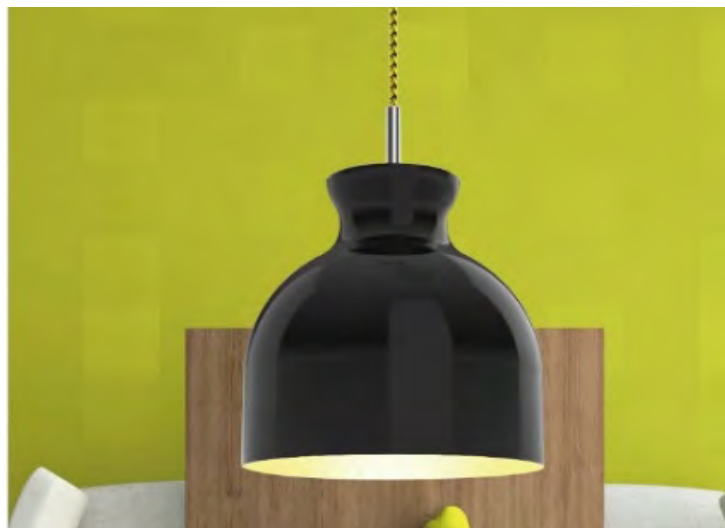

Referencia	Acabamento	Composição	Dimensão	Preço
L998651-E27	Preto	E27	260X1200mm	28,35 €

OBS.: Lâmpada E27 não incluída

## Candeeiros Suspensos



Referencia	Acabamento	Composição	Dimensão	Preço
CTSE27-LD241A	Cartão Canelado	E27	310X210mm	27,30 €

OBS.: Lâmpada E27 não incluída

## Candeeiros Suspensos



Referencia	Acabamento
<b>CSPD-D00B</b>	Ferro

Composição	Dimensão	Preço
E27	100X25mm	<b>9,45 €</b>



Referencia	Acabamento
<b>CSPD-Z2B</b>	Ferro

Composição	Dimensão	Preço
E27	100X75mm	<b>9,87 €</b>



Referencia	Acabamento
<b>CSPD-12B</b>	Ferro

Composição	Dimensão	Preço
E27	100X75mm	<b>13,13 €</b>

## Candeeiros de Teto



Referencia	Potencia	Temp. Cor
PL99840-4	40W	4000K

Composição	Dimensão	Preço
Fita de Led 24v	600X170mm	63,00 €



Referencia	Potencia	Temp. Cor
PL170855-4	42W	4000K

Composição	Dimensão	Preço
Fita de Led 24v	780X185mm	79,80 €

## Candeeiros de Mesa



Referencia	Potencia	Temp. Cor
TL170239-3	33W	3000K

Composição	Dimensão	Preço
Fita de Led 24v	160X480mm	60,90 €



Referencia	Potencia	Temp. Cor
TL170240-4	33W	4000K

Composição	Dimensão	Preço
Fita de Led 24v	160X435mm	32,55 €

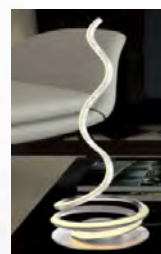



## Candeeiros de Parede



Referencia	Acabamento	
CPE27-LD20	Ferro/ Dourado	
Composição	Dimensão	Preço
E27	220X200mm	21,00 €

OBS.: Lâmpada E27 não incluída

## Apliques de Teto E27



Referencia	Cor	Composição	Base	Dimensão	Preço
CTE27-DT01	Antique Bronze				6,75 €
CTE27-DT11	Rose	Cabo e casquilho na mesma cor	E27	1,5Metro	6,75 €
CTE27-DT12	Bronze				7,04 €
CTE27-DT21	Gold				10,35 €

## Apliques de Teto E27



Referencia	Cor	Composição	Base	Dimensão	Preço
CORE27BZTX	Gold	Cabo em textil preto	E27	1,5Metro	8,67 €
CORE27BZTW					8,82 € <b>€193</b>



## Carregador EV Parede

REFERENCIA	POWER	CURRENT	VOLTAGE	IP	DIMENSAO
EVC-WB7K	7KW	32A-1Fase	250VAC	54	265x170x80mm
EVC-WB11K	11KW	16A-3Fases	480VAC		

## Carregador EV Portatil

REFERENCIA	POWER	CURRENT	VOLTAGE	IP	DIMENSAO
EVC-16AC	3,5KW	16A	200-250VAC	55	235X100X52mm
EVC-32AC	7KW	32A			



## Carregador EV Parede



Carregador de Parede, CE, UKCA, RoHS, TUV, CB  
 Cabo de carregamento EV com protecção em TPU (CE/TUV)  
 Ecrã LCD 2,4 e indicador LED em RGB  
 Protecção RCD: Type B (30mA AC +6mA DC)  
 IP54, Weather Proof; Leakage current protection  
 Ground protection, surge protection, O/U voltage protection  
 O/U frequency protection, Over temp protection  
 Modo de arranque: Cartão RFID / APP



Referencia	Power	Current	Voltage	IK	IP	Dimensão	Preço
EVC-WB7K	7KW	32A - 1Fase	250VAC				388,00 €
EVC-WB11K	11KW	16A - 3Fases	480VAC	IK08	54	265x170x80mm	470,00 €

## Carregador EV Portátil



Cabo de carregamento EV portátil 5mt, ICCB, CE, UKCA, RoHS  
 Cabo de carregamento com protecção em TPU (CE/TUV)  
 Ecrã LCD 2,8 e indicador LED em RGB  
 Protecção RCD: 30mA AC  
 IP55, Weather Proof; Leakage current protection  
 Ground protection, surge protection, O/U voltage protection  
 O/U frequency protection, Over temp protection  
 16A com Ficha BS/Schuko, Ficha azul CEE com 32A  
 Corpo em termoplástico PC94V-0  
 Escolha de Amperagem através de Botão

Referencia	Power	Current	Voltage	IP	Dimensão	Preço
EVC-16AC	3,5KW	16A				190,00 €
EVC-32AC	7KW	32A	200-250VAC	55	235x100x52mm	230,00 €

**Condições Gerais****1 – Informação:**

- A aquisição de bens à Lord Of Light, Lda implica a aceitação das condições gerais de venda para todos os clientes.
- A Lord Of Light reserva-se ao direito de descontinuar, alterar e/ou substituir os produtos apresentados, assim como, as suas características preços e condições gerais de venda sem aviso prévio.

**2 - Documentos:**

- A Lord Of Light, Lda só emite faturas como documento de transporte. Não emitimos Guias de Transporte ou Consignação.
- A Lord Of Light, Lda comercializa todos os seus artigos a pronto pagamento.

**Nota:** O não pagamento das faturas nos prazos estipulados importa o vencimento de juros de mora à taxa legal em vigor, bem como a perda dos descontos atribuídos, nos respectivos documentos.

**3 – Devoluções:**

A devolução de um produto comprado há menos de 15 dias poderá ser aceite desde que:

- A mesma seja solicitada junto dos nossos serviços e justificar o motivo da sua devolução.
- Os artigos que se encontrem nas mesmas condições aquando na altura da sua expedição, até 15 dias.
- Os artigos deverão ser acompanhados com documento onde conste o motivo da devolução e número da fatura de compra.
- O transporte de todas as devoluções é por conta e risco do cliente.
- Artigos que se encontrem em fim de linha/descontinuados não serão aceites para devolução.
- Artigos que pela quantidade ou especificidade não façam parte do nosso stock habitual não serão aceites para devolução.
- Não são aceites devoluções de Perfil.
- Artigos adquiridos há mais de 15 dias não serão aceites. A não ser com prévia aceitação da gerência.

**4 – Garantias:**

- A Lord Of Light, Lda confere 3 anos de garantia em todos os seus artigos, após a data de emissão da fatura.
- Quando o artigo apresentar avaria ou defeito de fabrico durante o período de garantia, a Lord Of Light reserva-se no direito de proceder à sua reparação ou substituição.
- O cliente deverá enviar o artigo com defeito ou avaria para as instalações da Lord Of Light, que posteriormente fará uma análise técnica e averiguação do mesmo, que ocorrerá num período máximo de 30 dias úteis.
- Para acionar a garantia de um artigo, o cliente deverá apresentar um documento onde conste o número e data da fatura de compra.
- As garantias não cobrem:
  - Uso impróprio ou negligente do artigo que pode causar danos irreversíveis, assim como variações de temperatura, contacto com água, instalações elétricas mal executadas e catástrofes naturais
  - Intervenção nos produtos, nomeadamente tentativas de reparação, manutenção inadequada, ligação a fontes de alimentação impróprias ou alterações nas mesmas, assim como cortes mal executados, que tenham sido efetuados pelo cliente.
  - A alteração de cor do produto com o tempo, devido à oxidação dos acabamentos.
- A Lord Of Light, Lda garante a assistência técnica de todo o material por nós comercializado, além do apoio telefónico.
- A Lord Of Light, Lda não assume custos inerentes a montagem e desmontagem de equipamentos avariados ou com defeito, assim como não é responsável por quaisquer danos diretos ou indiretos que possam resultar de avarias no produto, mesmo elegíveis em garantia.
- Em caso de avarias provocadas pelo uso indevido ou desgaste normal do produto, não serão cobertas pela garantia.

**5 – Transporte:**

- As entregas na área metropolitana de Lisboa são fornecidas pela Lord Of Light dentro de um prazo de 24 horas, excepto aquelas de valor mínimo, em que se torna necessário que existam entregas nas proximidades.
- Todas as encomendas em que as faturas não tenham valor superior a 150€ líquidos para ser enviada por transportadora, ficam sujeitas a portes.
- Todas as encomendas com perfil independentemente do valor, acresce o valor dos portes do perfil.
- As encomendas expedidas por transportadora para serem enviadas no próprio dia terão de ser solicitadas até as 16 Horas.
- Qualquer anomalia encontrada na receção das encomendas deve ser reportada, ao motorista e anotada no documento de transporte.
- As mercadorias viajam por conta e risco do cliente.

**6 – Encomenda de Produtos:**

- Todas as propostas têm uma validade nelas indicada.
- Em caso de encomendas de artigos que não façam parte do nosso stock habitual ou produtos específicos o prazo de entrega contará após aceitação da proposta pelo cliente e adjudicação com pagamento de 30% do valor total da proposta, os restantes 70% serão pagos no ato da entrega.
- Os prazos de entrega estabelecidos são apenas previsões, e em caso de força maior não poderão ser imputadas à Lord Of Light, responsabilidades de atrasos nas entregas dos produtos encomendados, nem o cliente terá o direito em exigir qualquer indemnização.

**7 - Descontos:**

- Os descontos comerciais praticados pela Lord Of Light variam consoante o volume de compras dos clientes, podendo ser alterados sem aviso prévio.

**8 – Litígio:**

1. Em caso de litígio é única e exclusivamente competente o Tribunal da Comarca de Loures.

**9 – Observações:**

- As dimensões indicadas na presente tabela normalmente são fornecidas pelos fabricantes, pelo que carecem sempre confirmação junto dos nossos serviços quando pretenderem instalar qualquer produto.