

CATÁLOGO



LORD OF LIGHT
ILUMINAÇÃO, LDA

2026



Fundada em setembro de 2009, a **Lord Of Light** afirma-se como uma empresa portuguesa de referência no setor da iluminação LED, especializada na importação, desenvolvimento e distribuição de soluções tecnológicas de elevada eficiência e desempenho.

Ao longo de mais de uma década de atividade, temos sustentado o nosso crescimento numa visão estratégica orientada para a inovação, competitividade e excelência operacional.

A consolidação da sua posição no mercado nacional resulta de uma política assente na qualidade, na consistência da oferta e na construção de relações de confiança de longo prazo com clientes, parceiros e distribuidores.

Através da marca registada **LOFL**, a **Lord Of Light** disponibiliza um portefólio abrangente de soluções de iluminação LED que combinam eficiência, fiabilidade técnica e conformidade com os mais exigentes padrões do setor. A empresa é representada pelos principais distribuidores de material elétrico e iluminação, reforçando a sua presença e notoriedade no mercado.

Com infraestruturas próprias de verificação e teste, assegura um rigoroso controlo de qualidade em todos os produtos comercializados, garantindo elevados níveis de desempenho, segurança e durabilidade.



A presença regular nas mais relevantes feiras internacionais do setor permite à empresa antecipar tendências, integrar inovação tecnológica e reforçar a sua competitividade num mercado em constante evolução.

A Lord Of Light posiciona-se como um parceiro estratégico, disponibilizando know-how técnico especializado, acompanhamento dedicado e soluções ajustadas às necessidades específicas de cada projeto.

O nosso compromisso é claro: excelência, competitividade e satisfação total do cliente.
Lord Of Light — Iluminar com inovação. Liderar com confiança.





ÍNDICE



219 810 928



925 317 226



geral@lordoflight.pt



www.lordoflight.pt

| | |
|--|----|
| Lâmpadas Spot - MR11/ MR16 / GU10 / E14 / E27 | 4 |
| Aros GU10 / MR16 | 9 |
| Lâmpadas G4 / G9 | 13 |
| Bulbs C37 / G45 / A60 / G60 / R63 / R80 / R50 / A125 | 16 |
| Corns 3U / 4U / Industriais | 24 |
| DownLights | 26 |
| Lâmpadas AR 111 | 32 |
| PAR 20-30-38 | 34 |
| Lâmpadas R7S | 36 |
| PLC G24/E27 | 39 |
| Lâmpadas T5 / T8 / Tri Proof / Réguas | 41 |
| Armaduras de Emergência | 46 |
| Lâmpadas e Acessórios de Piscina | 48 |
| Projetores de Exterior | 52 |
| Iluminação de Estádio | 58 |
| Iluminação de Jardim e Solar | 59 |
| Steplights | 68 |
| Painéis de Encastrar | 73 |
| Painéis de Superfície | 79 |
| Painéis com Sensor | 82 |
| Hay Bays | 84 |

| | |
|--|-----|
| Fitas de LED 12V | 88 |
| Fitas de LED 24V | 97 |
| Fitas de LED 220V | 111 |
| Fio Eletroluminescente (EI Wire) - Neon Flex | 114 |
| Controladores RGB - CCT - DIM - DMX | 121 |
| LED Digital | 131 |
| Dimmers | 136 |
| Kinetic Switch | 140 |
| Amplificadores | 144 |
| Sensores | 146 |
| Transformadores | 156 |
| Drives | 163 |
| Track Lights | 166 |
| Conectores / Conversores / Fio | 171 |
| Perfis / Perfis com fita LED embutida | 175 |
| Lineares | 184 |
| LedTube DIY | 187 |
| Módulos | 189 |
| Diversos LED | 191 |
| Candeeiros | 194 |
| Carregadores | 201 |

1

Spots GU10 / MR16 / MR11



Spots MR11 HP



| | |
|---------------------|------------------------|
| Cor | Branco |
| Ângulo de Abertura | 45 |
| Material | Aluminium + PS Plastic |
| CRI | 80 |
| Quantidade de Led´s | 4 pcs led |
| Índice de Proteção | IP40 |
| Fator de Potência | 0,9 |

| Referência | Potência | Lumens | Temp. Cor | Voltagem | Base | Dimensão | Led | Preço |
|------------|----------|--------|-----------|----------|------|------------|-----|-------|
| 040 | 4W | 400 | 6000K | 12VAC/DC | MR11 | Ø35 x 40mm | 4 | |
| 041 | | 350 | 3000K | | | | | |

Spots GU10 / MR16



| | |
|---------------------|------------------------|
| Cor | Cinza |
| Ângulo de Abertura | 60 |
| Material | Aluminium + PS Plastic |
| CRI | 80 |
| Quantidade de Led´s | 4 pcs led |
| Índice de Proteção | IP40 |
| Fator de Potência | 0,9 |

| Referência | Potência | Lumens | Temp. Cor | Voltagem | Base | Dimensão | Led | Preço |
|------------|----------|--------|-----------|--------------|------|------------|-----|-------|
| 187/N | 4W | 400 | 6000K | 12VAC/DC | MR16 | Ø50 x 58mm | 4 | |
| 002/N | | 300 | 6000K | 200 - 250VAC | GU10 | Ø50 x 60mm | | |
| 002/NWW | | 240 | 3000K | | | Ø50 x 57mm | | |
| 002 | | 300 | 6000K | | | | | |
| 002/WW | | 240 | 3000K | | | | | |



| | |
|---------------------|------------------------|
| Cor | Cinza |
| Ângulo de Abertura | 60 |
| Material | Aluminium + PS Plastic |
| CRI | 80 |
| Quantidade de Led´s | 5 pcs led |
| Índice de Proteção | IP40 |
| Fator de Potência | 0,9 |

| Referência | Potência | Lumens | Temp. Cor | Voltagem | Base | Dimensão | Led | Preço |
|------------|----------|--------|-----------|--------------|------|------------|-----|-------|
| 1-KG5X1-6 | 5W | 450 | 6000K | 175 - 265VAC | GU10 | Ø50 x 58mm | 5 | |
| 1-KG5X1-3 | | 390 | 3000K | | | | | |



| | |
|---------------------|------------------------|
| Cor | Cinza |
| Ângulo de Abertura | 60 |
| Material | Aluminium + PS Plastic |
| CRI | 80 |
| Quantidade de Led´s | 3 pcs led |
| Índice de Proteção | IP40 |
| Fator de Potência | 0,9 |

| Referência | Potência | Lumens | Temp. Cor | Voltagem | Base | Dimensão | Led | Preço |
|------------|----------|--------|-----------|--------------|------|------------|-----|-------|
| 009/N | 6W | 550 | 6000K | 175 - 265VAC | GU10 | Ø50 x 60mm | 3 | |
| 010/N | | 500 | 3000K | | | | | |

Spots GU10 / MR16 COB



| | |
|---------------------|------------------------|
| Cor | Cinza / Branco |
| Ângulo de Abertura | 60 |
| Material | Aluminium + PS Plastic |
| CRI | 80 |
| Quantidade de Led's | 1 pcs COB |
| Índice de Proteção | IP40 |
| Fator de Potência | 0,9 |

| Referência | Potência | Lumens | Temp. Cor | Voltagem | Base | Dimensão | Led | Preço |
|------------|----------|--------|-----------|--------------|------|------------|-----|-------|
| 1-KG5COB-6 | | | 6000K | | | | | |
| 1-KG5COB-4 | 5W | 500 | 4000K | 200 - 250VAC | GU10 | Ø50 x 56mm | 1 | |
| 1-KG5COB-3 | | | 3000K | | | | | |



BRIDGELUX
The Magic of Light™



| | |
|---------------------|------------------------|
| Cor | Cinza |
| Ângulo de Abertura | 60 |
| Material | Aluminium + PS Plastic |
| CRI | 80 |
| Quantidade de Led's | 1 pcs COB |
| Índice de Proteção | IP40 |
| Fator de Potência | 0,9 |

| Referência | Potência | Lumens | Temp. Cor | Voltagem | Base | Dimensão | Led | Preço |
|------------|----------|--------|-----------|-------------|------|--------------|-----|-------|
| 025/MRC | 5W | 500 | 6000K | 12VAC/DC | MR16 | Ø50 x 51mm | | |
| 026/NCOB | | 450 | 3000K | 85 - 265VAC | GU10 | Ø50 x 61,5mm | 1 | |
| 025/7MRC | 7W | 700 | 6000K | 12VAC/DC | MR16 | Ø50 x 78mm | | |
| 026/7MRC | | 650 | 3000K | | | | | |



| | |
|---------------------|------------------------|
| Cor | Cinza |
| Ângulo de Abertura | 60 |
| Material | Aluminium + PS Plastic |
| CRI | 80 |
| Quantidade de Led's | 1 pcs COB |
| Índice de Proteção | IP40 |
| Fator de Potência | 0,9 |

| Referência | Potência | Lumens | Temp. Cor | Voltagem | Base | Dimensão | Led | Preço |
|------------|----------|--------|-----------|-------------|------|------------|-----|-------|
| 025/7COBN | 7W | 700 | 6000K | 85 - 265VAC | GU10 | Ø50 x 60mm | 1 | |



| | |
|---------------------|------------------------|
| Cor | Cinza |
| Ângulo de Abertura | 38 |
| Material | Aluminium + PS Plastic |
| CRI | 80 |
| Quantidade de Led's | 1 pcs COB |
| Índice de Proteção | IP40 |
| Fator de Potência | 0,9 |

| Referência | Potência | Lumens | Temp. Cor | Voltagem | Base | Dimensão | Led | Preço |
|------------|----------|--------|-----------|-------------|------|----------------|-----|-------|
| 026/8COBN | 8W | 640 | 3000K | 85 - 265VAC | GU10 | Ø49,5 x 52,5mm | Sim | |

Spots GU10 / MR16 SMD



| | |
|---------------------|------------------------|
| Cor | Branco |
| Ângulo de Abertura | 120 |
| Material | Aluminium + PS Plastic |
| CRI | 80 |
| Quantidade de Led's | 12 pcs SMD |
| Índice de Proteção | IP40 |
| Fator de Potência | 0,9 |

| Referência | Potência | Lumens | Temp. Cor | Voltagem | Base | Dimensão | Led | Preço |
|------------|----------|--------|-----------|--------------|------|------------|---------|-------|
| GU06/12SMD | | 400 | 6000K | | | | | |
| GU04/12SMD | 5W | 380 | 4000K | 220 - 250VAC | GU10 | Ø50 x 60mm | 2835-12 | |
| GU03/12SMD | | 360 | 3000K | | | | | |



| | |
|---------------------|------------------------|
| Cor | Branco |
| Ângulo de Abertura | 120 |
| Material | Aluminium + PS Plastic |
| CRI | 80 |
| Quantidade de Led's | 12 pcs SMD |
| Índice de Proteção | IP40 |
| Fator de Potência | 0,9 |

| Referência | Potência | Lumens | Temp. Cor | Voltagem | Base | Dimensão | Led | Preço |
|------------|----------|--------|-----------|--------------|------|------------|---------|-------|
| 030/7D-3 | 7W | 500 | 3000K | 220 - 250VAC | GU10 | Ø50 x 60mm | 2835-12 | |



| | |
|---------------------|------------------------|
| Cor | Branco |
| Ângulo de Abertura | 120 |
| Material | Aluminium + PS Plastic |
| CRI | 80 |
| Quantidade de Led's | 12 pcs SMD |
| Índice de Proteção | IP40 |
| Fator de Potência | 0,9 |

| Referência | Potência | Lumens | Temp. Cor | Voltagem | Base | Dimensão | Led | Preço |
|------------|----------|--------|-----------|-------------|------|------------|---------|-------|
| 029/7.5MR | | | 6000K | 12VAC/DC | MR16 | | | |
| 029/7.5 | 7,5W | 690 | 4000K | 85 - 265VAC | GU10 | Ø50 x 51mm | 2835-24 | |
| 030/7.5 84 | | | 4000K | | | | | |

Spots RGB



| | |
|---------------------|------------------------|
| Cor | Cinza |
| Ângulo de Abertura | 60 |
| Material | Aluminium + PS Plastic |
| CRI | 80 |
| Quantidade de Led's | 1 pcs HP |
| Índice de Proteção | IP40 |
| Fator de Potência | 0,9 |

| Referência | Potência | Temp. Cor | Voltagem | Base | Dimensão | Led | Preço |
|------------|----------|-----------|--------------|------|-----------------|-----|-------|
| 005 | | | | E14 | | | |
| 006 | 3W | R G B | 200 - 250VAC | E27 | Ø50 x 60 / 78mm | 1 | |
| 033 | | | | GU10 | | | |

Módulo Downlight



| | |
|---------------------|------------------------|
| Cor | Preto |
| Ângulo de Abertura | 24 |
| Material | Aluminium + PS Plastic |
| CRI | 90 |
| Quantidade de Led's | 1 pcs HP |
| Índice de Proteção | IP54 |
| Fator de Potência | 0,9 |

LIFUD CREE
LED Driver LEDs



| Referência | Potência | Lumens | Temp. Cor | Voltagem | Base | Dimensão | Led | Preço |
|---------------|----------|--------|-----------|--------------|-------|------------|-------------|-------|
| DL-CL08-213-3 | 8W | 800 | 2700K | | | | 1-Cree 1304 | |
| DL-CL08-213-4 | | | 4000K | 200 - 265VAC | Metal | 63 x Ø54mm | | |
| DL-CL12-213-3 | 11,5W | 1200 | 2700K | | | | 1-Cree 1507 | |
| DL-CL12-213-4 | | | 4000K | | | | | |

2

Aros GU10 / MR16

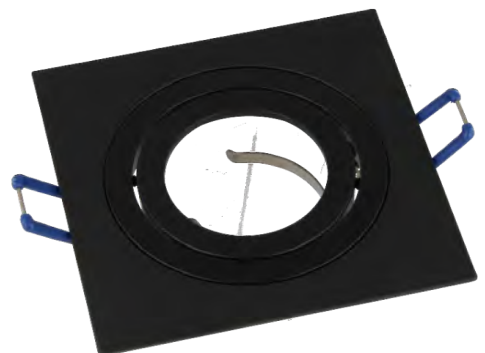

Aros GU10 / MR16

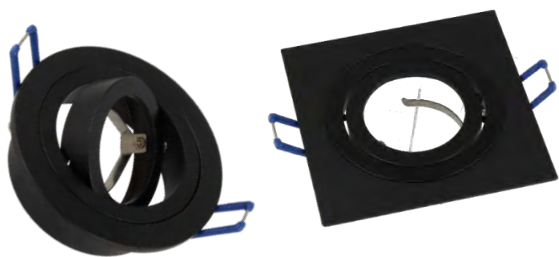
**Especificações técnicas**

Material: Alumínio
 Funcionalidade: Orientável
 Cor: Preto

| Referência | Corte | Dimensão | Base | Preço |
|------------|-------|-------------|----------|-------|
| 648/OP | Ø78mm | Ø94mm | Redondo | |
| 649/OP | 78mm | 94mm x 94mm | Quadrado | |

**Especificações técnicas**

Material: Alumínio
 Funcionalidade: Orientável

| Referência | Corte | Dimensão | Base | Preço |
|------------|-------|-------------|--------|-------|
| 800/OB | 72mm | 82mm x 82mm | Branco | |

**Especificações técnicas**

Material: Alumínio
 Funcionalidade: Orientável

| Referência | Corte | Dimensão | Base | Preço |
|------------|-------|----------|--------|-------|
| 6101/ON | Ø65mm | Ø88mm | Nickel | |

**Especificações técnicas**

Material: Alumínio
 Funcionalidade: Orientável

| Referência | Corte | Dimensão | Base | Preço |
|------------|-------|-------------|--------|-------|
| 6401/OB | 63mm | 87mm x 87mm | Branco | |

**Especificações técnicas**

Material: Alumínio
 Funcionalidade: Orientável

| Referência | Corte | Dimensão | Base | Preço |
|------------|-------|----------|--------|-------|
| 808/OB | Ø74mm | Ø84mm | Branco | |
| 808/ON | | | Nickel | |

**Especificações técnicas**

Material: Alumínio
 Funcionalidade: Fixo
 IP: 65

| Referência | Corte | Dimensão | Base | Preço |
|------------|-------|----------|--------|-------|
| 650/FB | Ø74mm | Ø84mm | Branco | |
| 650/FN | | | Nickel | |

Fixadores/Bases para módulos LED



Aplicável a todas as referências:

Compatível com:
- DL-CL08-213 e DL-CL12-213
- GU10 e MR16

Lâmpada não incluída.



Especificações técnicas

Material: Policarbonato
Funcionalidade: Direcionável
Corte: Ø72mm
Dimensão: 92mm x 92mm

| Referência | Cor | Preço |
|--------------|--------|-------|
| DL-FIX SF221 | Branco | |



Especificações técnicas

Material: Policarbonato
Funcionalidade: Direcionável
Corte: 72mm x 152mm
Dimensão: 92mm x 172mm

| Referência | Cor | Preço |
|--------------|--------|-------|
| DL-FIX SF222 | Branco | |



Especificações técnicas

Material: Policarbonato
Funcionalidade: Fixo
Corte: Ø70mm
Dimensão: Ø90mm

| Referência | Cor | Preço |
|--------------|--------|-------|
| DL-FIX SF224 | Branco | |



Especificações técnicas

Material: Policarbonato
Funcionalidade: Fixo
Corte: Ø80mm
Dimensão: Ø100mm

| Referência | Cor | Preço |
|--------------|--------|-------|
| DL-FIX SF225 | Branco | |

Fixadores/Bases para módulos LED

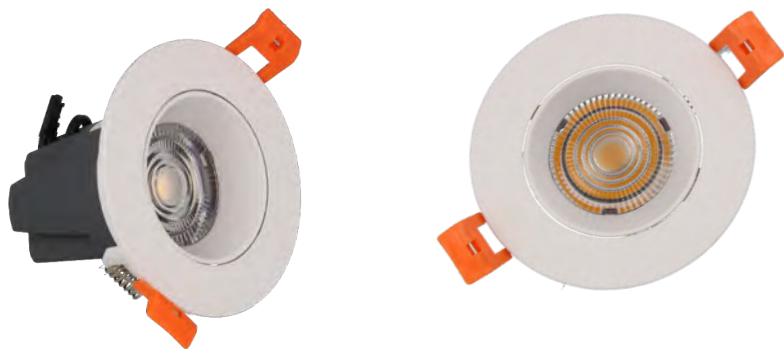

Especificações técnicas

Material: Policarbonato
 Funcionalidade: Direcionável
 Corte: Ø70mm
 Dimensão: Ø90mm

| Referência | Cor | Preço |
|--------------|--------|-------|
| DL-FIX SF226 | Branco | |

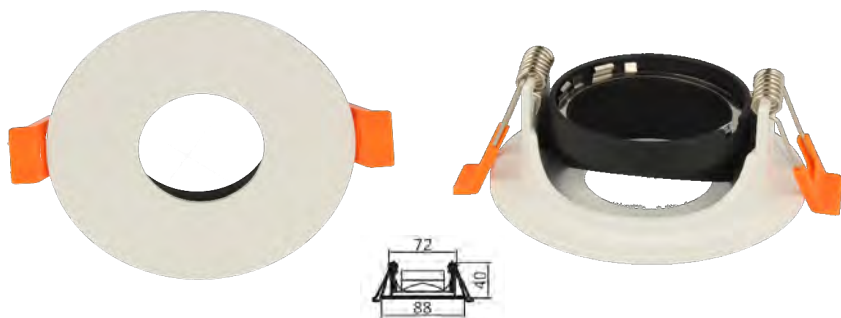

Especificações técnicas

Material: Policarbonato
 Funcionalidade: Direcionável
 Corte: Ø72mm
 Dimensão: Ø88 x 40mm

| Referência | Cor | Preço |
|--------------|--------|-------|
| DL-FIX SE218 | Branco | |

Spot em Gesso



Obs.: Aro interior GU10 em plástico

| Referência | Cor | Preço |
|-------------|--------|-------|
| DL-FIX 1015 | Branco | |



Ø130

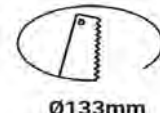

Ø133mm

3

Lâmpadas G4 / G9



G4 SMD

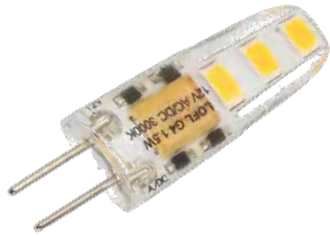

| | |
|---------------------|----------------------|
| Cor | Transparente |
| Ângulo de Abertura | 360 |
| Material | Aluminium + Silicone |
| CRI | 80 |
| Quantidade de Led's | 6 pcs SMD |
| Índice de Proteção | IP40 |

| Referência | Potência | Lumens | Temp. Cor | Voltagem | Base | Dimensão | Led | Preço |
|------------|----------|--------|-----------|----------|------|------------|--------|-------|
| 078/1.5-3 | 1,5W | 140 | 3000K | 12VAC/DC | G4 | Ø10 x 38mm | 2835-6 | |



| | |
|---------------------|------------------------|
| Cor | Cinza |
| Ângulo de Abertura | 360 |
| Material | Aluminium + PS Plastic |
| CRI | 80 |
| Quantidade de Led's | 20 pcs SMD |
| Índice de Proteção | IP40 |

| Referência | Potência | Lumens | Temp. Cor | Voltagem | Base | Dimensão | Led | Preço |
|------------|----------|--------|-----------|----------|------|------------|---------|-------|
| 077/2,5 | 2,5W | 260 | 6000K | 12VAC/DC | G4 | Ø15 x 42mm | 3014-20 | |
| 078/2,5 | | 240 | 3000K | | | | | |



| | |
|---------------------|------------------------|
| Cor | Branco |
| Ângulo de Abertura | 360 |
| Material | Aluminium + PS Plastic |
| CRI | 80 |
| Quantidade de Led's | 33 pcs SMD |
| Índice de Proteção | IP40 |

| Referência | Potência | Lumens | Temp. Cor | Voltagem | Base | Dimensão | Led | Preço |
|------------|----------|--------|-----------|----------|------|------------|---------|-------|
| 077/3P | 3W | 260 | 6000K | 12VAC/DC | G4 | Ø16 x 35mm | 2835-33 | |
| 078/3P | | 240 | 3000K | | | | | |



| | |
|---------------------|------------|
| Cor | Branco |
| Ângulo de Abertura | 60 |
| Material | PS Plastic |
| CRI | 80 |
| Quantidade de Led's | 1 pcs HP |
| Índice de Proteção | IP40 |

| Referência | Potência | Lumens | Temp. Cor | Voltagem | Base | Dimensão | Led | Preço |
|------------|----------|--------|-----------|----------|------|------------|--------|-------|
| 077/3 | | | 6000K | | | | | |
| 078/3 | 3W | 140 | 3000K | 12VAC/DC | G4 | Ø11 x 23mm | 1 - HP | |

G9 SMD



| | |
|---------------------|----------------------|
| Cor | Opalino |
| Ângulo de Abertura | 360 |
| Material | Aluminium + Silicone |
| CRI | 80 |
| Quantidade de Led's | 6 pcs SMD |

| Referência | Potência | Lumens | Temp. Cor | Voltagem | Base | Dimensão | Led | Preço |
|------------|----------|--------|-----------|--------------|------|------------|---------|-------|
| 087/SE | 2.5W | 220 | 6000K | 200 - 250VAC | G9 | Ø15 x 46mm | 2835-16 | |
| 088/SE | | 200 | 3000K | | | | | |



| | |
|---------------------|----------------------|
| Cor | Transparente |
| Ângulo de Abertura | 360 |
| Material | Aluminium + Silicone |
| CRI | 80 |
| Quantidade de Led's | 64 pcs SMD |

| Referência | Potência | Lumens | Temp. Cor | Voltagem | Base | Dimensão | Led | Preço |
|------------|----------|--------|-----------|--------------|------|------------|---------|-------|
| 087/S4 | 3W | 270 | 4000K | 200 - 250VAC | G9 | Ø15 x 46mm | 3014-64 | |
| 088/S | | 250 | 3000K | | | | | |



| | |
|---------------------|------------------------|
| Cor | Transparente |
| Ângulo de Abertura | 360 |
| Material | Aluminium + PS Plastic |
| CRI | 80 |
| Quantidade de Led's | 51 / 75 pcs SMD |

| Referência | Potência | Lumens | Temp. Cor | Voltagem | Base | Dimensão | Led | Preço |
|------------|----------|--------|-----------|--------------|------|--------------|---------|-------|
| 087/3P | 3,5W | 300 | 6000K | 200 - 250VAC | G9 | Ø16,5 x 50mm | 2835-51 | |
| 088/3P | | | 3000K | | | | | |
| 087/860 | 4,5W | 400 | 6000K | | | Ø16 x 60mm | 2835-75 | |
| 087/840 | | 370 | 4000K | | | | | |

G9 COB



| | |
|---------------------|--------------|
| Cor | Transparente |
| Ângulo de Abertura | 360 |
| Material | Aluminium |
| CRI | 80 |
| Quantidade de Led's | 2 pcs COB |

| Referência | Potência | Lumens | Temp. Cor | Voltagem | Base | Dimensão | Led | Preço |
|------------|----------|--------|-----------|--------------|------|-----------|-----|-------|
| 087/COBN | 4,5W | 410 | 6000K | 200 - 250VAC | G9 | 14 x 50mm | 2 | |
| 088/COBN | | 390 | 3000K | | | | | |



| | |
|---------------------|------------------------|
| Cor | Transparente |
| Ângulo de Abertura | 180 |
| Material | Aluminium + PS Plastic |
| CRI | 80 |
| Quantidade de Led's | 1 pcs SMD |

| Referência | Potência | Lumens | Temp. Cor | Voltagem | Base | Dimensão | Led | Preço |
|------------|----------|--------|-----------|--------------|------|---------------|-----|-------|
| 087/2 | 2W | 180 | 6000K | 200 - 250VAC | G9 | Ø17 x 45,75mm | 1 | |
| 088/2 | | 160 | 3000K | | | | | |

4

Bulbs



Bulb C37



| Referência | Potência | Lumens | Temp. Cor | Base | Led SMD | Preço |
|-------------|----------|--------|-----------|------|---------|-------|
| C37E14/4W-6 | 4W | 400 | 6000K | E14 | 2835-8 | |
| C37E14/4W-3 | | 380 | 3000K | | | |
| C37E27/4W-6 | | 400 | 6000K | E27 | | |
| C37E27/4W-3 | | 380 | 3000K | | | |
| C37E14/6W-6 | 6W | 640 | 6000K | E14 | 2835-12 | |
| C37E14/6W-3 | | 610 | 3000K | | | |
| C37E27/6W-6 | | 640 | 6000K | E27 | | |
| C37E27/6W-3 | | 610 | 3000K | | | |

Bulb G45



| Referência | Potência | Lumens | Temp. Cor | Base | Led SMD | Preço |
|-------------|----------|--------|-----------|------|---------|-------|
| G45E14/4W-6 | 4W | 432 | 6000K | E14 | 2835-8 | |
| G45E14/4W-3 | | 415 | 3000K | | | |
| G45E27/4W-6 | | 432 | 6000K | E27 | | |
| G45E27/4W-3 | | 415 | 3000K | | | |
| G45E14/6W-6 | 6W | 640 | 6000K | E14 | 2835-12 | |
| G45E14/6W-3 | | 610 | 3000K | | | |
| G45E27/6W-6 | | 640 | 6000K | E27 | | |
| G45E27/6W-3 | | 610 | 3000K | | | |

Bulb A60



| Referência | Potência | Lumens | Temp. Cor | Base | Led SMD | Preço |
|-------------|----------|--------|-----------|------|---------|-------|
| 044/ECO-6 | 10W | 1100 | 6000K | E27 | 3020-10 | |
| 044/ECO-4 | | 1050 | 4000K | | | |
| 045/ECO-3 | | 1000 | 3000K | | | |
| 044/ECO15-6 | 15W | 1500 | 6000K | E27 | 3020-15 | |
| 044/ECO15-4 | | 1450 | 4000K | | | |
| 045/ECO15-3 | | 1400 | 3000K | | | |
| 044/24 | 10W | 1000 | 6000K | E27 | 3020-10 | |
| 045/24 | | 900 | 3000K | | | |

Bulb G60



| Referência | Potência | Lumens | Temp. Cor | Base | Led SMD | Preço |
|------------|----------|--------|-----------|------|---------|-------|
| 103/WECO | 7W | 560 | 6000K | E27 | 2835-28 | |
| 103/WWECO | | 470 | 3000K | | | |

Bulb A125



| Referência | Potência | Lumens | Temp. Cor | Base | Led SMD | Preço |
|------------|----------|--------|-----------|------|---------|-------|
| 044/125 | 12W | 1055 | 6000K | E27 | 2835-24 | |
| 045/125 | | 900 | 3000K | | | |
| 045/125F8M | 12W | 1055 | 3000K | E27 | 8 | |

Bulb Chama 4W Gold



| Referência | Potência | Lumens | Temp. Cor | Base | Led SMD | Preço |
|------------|----------|--------|-----------|------|---------|-------|
| 144/W | 6W | 470 | 6000K | E14 | 2835-12 | |
| 144/WW | | 440 | 3000K | | | |

Bulb R63



| Referência | Potência | Lumens | Temp. Cor | Base | Led SMD |
|------------|----------|--------|-----------|------|---------|
| 043 | 7W | 550 | 3000K | E27 | 5630-14 |
| 042/840 | | 650 | 4000K | | |

Bulb R50



| Referência | Potência | Lumens | Temp. Cor | Base | Led SMD |
|------------|----------|--------|-----------|------|---------|
| 050/ECO-3 | 6W | 390 | 3000K | E14 | 2835-24 |

Bulb C37 Filamento



| Referência | Potência | Lumens | Temp. Cor | Base | Led SMD |
|------------|----------|--------|-----------|------|---------|
| 107/FIL | 2W | 230 | 3000K | E14 | 2 |
| 107/4FGD | 4W | 330 | | | 4 |



| Referência | Potência | Lumens | Temp. Cor | Base | Led SMD | Preço |
|-------------|----------|--------|-----------|------|---------|-------|
| 107/4FDGD | 4W | 330 | 3000K | E14 | 4 | |
| 107/4FDGD27 | | | | E27 | | |

Bulb G45 Filamento 5W



| Referência | Potência | Lumens | Temp. Cor | Base | Led SMD | Preço |
|--------------|----------|--------|-----------|------|---------|-------|
| G45E27/5W-3F | 5W | 550 | 3000K | E27 | 4 | |



| Referência | Potência | Lumens | Temp. Cor | Base | Led SMD | Preço |
|------------|----------|--------|-----------|------|---------|-------|
| 142/4FGD | 4W | 330 | 3000K | E14 | 4 | |
| 143/4FGD | | | | E27 | | |

Bulb A60 Filamento



| Referência | Potência | Lumens | Temp. Cor | Base | Led SMD | Preço |
|------------|----------|--------|-----------|------|---------|-------|
| 045/8FIL | 8W | 850 | 3000K | E27 | 6 | |



| Referência | Potência | Lumens | Temp. Cor | Base | Led SMD | Preço |
|------------|----------|--------|-----------|------|---------|-------|
| 045/8FGD | 6,5W | 850 | 3000K | E27 | 6 | |

Bulb ST 64 Filamento



| Referência | Potência | Lumens | Temp. Cor | Base | Led SMD | Preço |
|------------|----------|--------|-----------|------|---------|-------|
| 046/ST8GD | 8W | 850 | 3000K | E27 | 6 | |

Bulb G95 / G125 Filamento



| Referência | Potência | Lumens | Temp. Cor | Base | Led SMD | Preço |
|------------|----------|--------|-----------|------|---------|-------|
| 045/125F6 | 6W | 650 | 3000K | E27 | 6 | |
| 045/125F8 | 8W | 800 | 3000K | E27 | 6 | |



| Referência | Potência | Lumens | Temp. Cor | Base | Led SMD |
|-------------|----------|--------|-----------|------|---------|
| 045/95F8GD | 6,5W | 800 | 3000K | E27 | 8 |
| 045/125F8GD | 6,5W | 800 | 3000K | E27 | 8 |



| Referência | Potência | Lumens | Temp. Cor | Base | Led SMD |
|--------------|----------|--------|-----------|------|---------|
| 045/125F8HSD | 8W | 800 | 3000K | E27 | 8 |

Bulb SOFT LED A60 / G125 / ST64



| Referência | Potência | Lumens | Temp. Cor | Base | Dimensões | Preço |
|--------------|----------|--------|-----------|------|--------------|-------|
| 045/SOFT4WG | 4W | 300 | 2300K | E27 | Ø60 x 110mm | |
| G125/SOFT6WG | 6W | 450 | | | Ø125 x 172mm | |
| ST64/SOFT6WG | | | | | Ø64 x 145mm | |

Bulb R50 Filamento E14



| Referência | Potência | Lumens | Temp. Cor | Base | Led SMD | Preço |
|------------|----------|--------|-----------|------|---------|-------|
| R50/14F2 | 2W | 220 | 3000K | E14 | 2 | |

Bulb R63 Filamento E27



| Referência | Potência | Lumens | Temp. Cor | Base | Led SMD | Preço |
|------------|----------|--------|-----------|------|---------|-------|
| R63/27F6 | 6W | 500 | 3000K | E27 | 6 | |

Bulb R80 Filamento E27



| Referência | Potência | Lumens | Temp. Cor | Base | Led SMD | Preço |
|------------|----------|--------|-----------|------|---------|-------|
| R80/27F8 | 8W | 600 | 3000K | E27 | 8 | |

Bulbs Decorativas



| Referência | Potência | Temp. Cor | Base | Formato | Preço |
|-------------|----------|-----------|------|----------------|-------|
| GCE27-4HP | 4W | 2300K | E27 | Garrafa Gold | |
| GCE27-4HPSM | | | | Garrafa Smoked | |

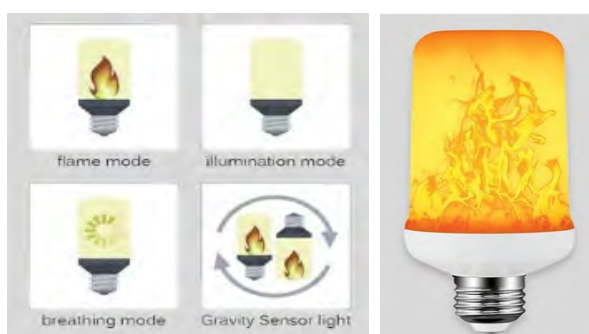

| Referência | Potência | Temp. Cor | Base | Efeito | Led SMD | Preço |
|------------|----------|-----------|------|--------|-------------|-------|
| CHAMA/E27 | 4W-6W | 1900K | E27 | Chama | Ø63 x 150mm | |

Bulb A60 RGB+CCT (TUYA)



| Referência | Potência | Temp. Cor | Base | Tipo | Led SMD | Preço |
|------------|----------|-----------|------|------|-------------|-------|
| 044/RGB-WT | 10W | RGB + CCT | E27 | WIFI | Ø63 x 150mm | |

Bulb A60 MOSQUITO KILLER



| Referência | Potência | Lumens | Temp. Cor | Base | Led SMD | Preço |
|------------|----------|--------|-----------|------|---------|-------|
| 044/MOS | 8W | 560 | 1800K | E27 | 1 | |

5

Corns



Corns



| Referência | Potência | Lumens | Temp. Cor | Voltagem | Base | Dimensão | LED smd |
|-------------|----------|--------|-----------|-------------|------|-------------|---------|
| 159/W3U | 7W | 600 | 6000K | 85 - 265VAC | E27 | Ø43 x 130mm | 2835-36 |
| 159/WW3U | | | 3000K | | | | |
| 160/WW3U | 12W | 1020 | 3000K | | | Ø53 x 175mm | 2835-60 |
| 160/WW4U | 20W | 1700 | 3000K | | | | |
| 159/30W-4U | 30W | 3000 | 6000K | | | Ø73 x 220mm | 2835-96 |
| 160/30WW-4U | | 2600 | 3000K | | | | |

Corns Industriais



| Referência | Potência | Lumens | Temp. Cor | Voltagem | Base | Dimensão | Led SMD | Preço |
|------------|----------|--------|-----------|--------------|------|-------------|---------|-------|
| CORN/30W-6 | 30W | 3 000 | 6000K | 175 - 265VAC | E27 | Ø90 x 218mm | 2835 | |
| CORN/50W-6 | 50W | 5 000 | | | | | | |



| Referência | Potência | Lumens | Temp. Cor | Voltagem | Base | Dimensão | Led SMD | Preço |
|------------|----------|--------|-----------|--------------|------|--------------|---------|-------|
| 072/WW | 60W | 6 100 | 3000K | 175 - 265VAC | E40 | Ø120 x 265mm | 2835 | |
| 072/840 | | | 4000K | | | | | |
| 072 | | | 6000K | | | | | |

6

Down Lights

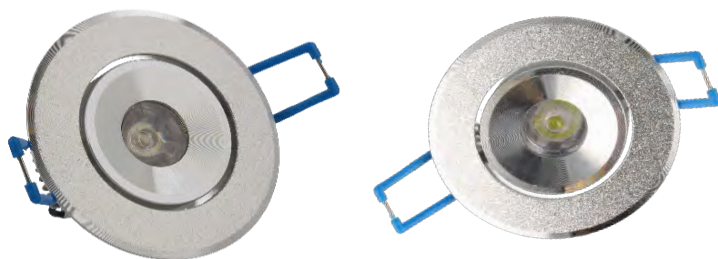

Downlights

**Especificações técnicas**

Material: Alumínio
 Funcionalidade: Direcionável
 Cobertura: Transparente
 Tipo drive: Externo

EPISTAR

| Referência | Potência | Lumens | Temp. Cor | Voltagem | Corte | Dimensão | Cor | Preço |
|------------|----------|--------|-----------|-------------|-------|------------|--------|-------|
| 120/3B | 3W | 220 | 3000K | 85 - 265VAC | Ø55mm | Ø68 x 22mm | Branco | |
| 119/3B | | | 6000K | | | | | |
| 120/3 | 200 | 3000K | | | | | | |
| 119/3 | | 6000K | | | | | | |
| 119/5RGB | 5W | | R G B | | | | | |

**Especificações técnicas**

Material: Alumínio
 Funcionalidade: Direcionável
 Cobertura: Transparente
 Tipo drive: Externo

EPISTAR

| Referência | Potência | Lumens | Temp. Cor | Voltagem | Corte | Dimensão | Leds | Preço |
|------------|----------|--------|-----------|-------------|-------|------------|------|-------|
| 119/9 | 9W | 800 | 6000K | 85 - 265VAC | Ø65mm | Ø85 x 95mm | 3 | |

**Especificações técnicas**

Material: Alumínio
 Funcionalidade: Direcionável
 Cobertura: Transparente
 Tipo drive: Externo

EPISTAR

| Referência | Potência | Lumens | Temp. Cor | Voltagem | Corte | Dimensão | Leds | Preço |
|------------|----------|--------|-----------|-------------|--------|-------------|------|-------|
| 123 | 15W | 1500 | 6000K | 85 - 265VAC | Ø130mm | Ø140 x 90mm | 15 | |
| 124 | | 1350 | 3000K | | | | | |



BRIDGELUX
 The Magic of Light™



| Referência | Potência | Lumens | Temp. Cor | Voltagem | Corte | Dimensão | Leds | Preço |
|------------|----------|--------|-----------|-------------|-------------|-------------|------|-------|
| 199/WW | 30W | 2600 | 3000K | 85 - 265VAC | 225 x 125mm | 243 x 152mm | 3 | |

Downlight Gimble

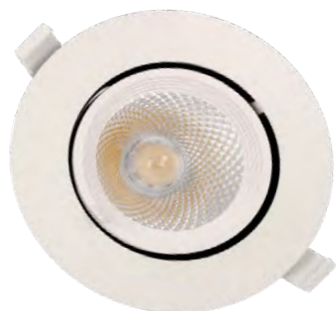

CITIZEN
 Micro HumanTech
45°

IP 40

FP
0,90CRI
>80

| Referência | Potência | Lumens | Temp. Cor | Voltagem | Corte | Dimensão | Cor | Preço |
|------------|----------|--------|-----------|--------------|-------|--------------|--------|-------|
| 217/PW | 15W | 1500 | 4000K | 200 - 265VAC | Ø95mm | Ø110 x 125mm | Branco | |
| 216/PW | 25W | 2500 | | | | | | |

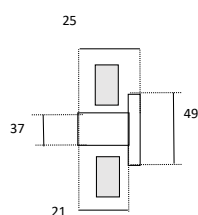
Mini-Downlights

90°

IP 40

FP
0,95CRI
>80

Obs: Ideal p/ aplicar no exterior

| Referência | Potência | Lumens | Temp. Cor | Voltagem | Corte | Dimensão | Cor | Preço |
|------------|----------|--------|-----------|-------------|-------|----------|--------|-------|
| 648/3R-4 | 3W | 280 | 4000K | 85 - 265VAC | Ø37mm | Ø49mm | Branco | |
| 648/3R-3 | | | 3000K | | | | | |

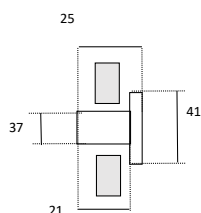
90°

IP 40

FP
0,95CRI
>80

Obs: Ideal p/ aplicar no exterior

| Referência | Potência | Lumens | Temp. Cor | Voltagem | Corte | Dimensão | Cor | Preço |
|------------|----------|--------|-----------|-------------|-------|-----------|--------|-------|
| 648/3Q-4 | 3W | 280 | 4000K | 85 - 265VAC | Ø37mm | 41 x 41mm | Branco | |
| 648/3Q-3 | | | 3000K | | | | | |

Downlight 20W/30W

**Especificações técnicas**

Material: Alumínio
 Funcionalidade: Direcionável
 Cobertura: Transparente
 Tipo drive: Externo

BRIDGELUX
 THE MAGIC OF LIGHT™
120°

IP 40

FP
0,90CRI
>80

| Referência | Potência | Lumens | Temp. Cor | Voltagem | Corte | Dimensão | Cor | Preço |
|------------|----------|--------|-----------|--------------|--------|--------------|--------|-------|
| 137/N | 20W | 1800 | 6000K | 200 - 265VAC | Ø188mm | Ø198 x 100mm | Branco | |
| 137/NWW | | 1650 | 3000K | | | | | |
| 174/N | 30W | 2700 | 6000K | | Ø210mm | Ø230 x 74mm | | |
| 174/NWW | | 2200 | 3000K | | | | | |

Downlight CCT

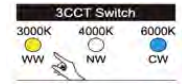

| Referência | Potência | Lumens | Temp. Cor | Voltagem | Corte | Dimensão | Led SMD | Preço |
|--------------|----------|--------|-----------|--------------|--------------|---------------|---------|-------|
| DL-7W-CCT+D | 7W | 700 | 3CCT | 175 - 265VAC | Ø68 - 80mm | Ø95 x Ø57,5mm | 1 | |
| DL-15W-CCT+D | 15W | 1500 | | | Ø120 - 130mm | Ø145 x Ø65mm | | |

Aro Downlight CCT



| Referência | Cor |
|------------|--------|
| DLR-7N | Nickel |
| DLR-15N | |

Downlights com IP 54

Especificações técnicas

Material: Alumínio
 Funcionalidade: Fixo
 Cobertura: Transparente
 Tipo Drive: Interno



| Referência | Potência | Lumens | Temp. Cor | Voltagem | Corte | Dimensão | Preço |
|------------|----------|--------|-----------|-------------|--------|--------------|-------|
| DL-PL8W-6 | 8W | 720 | 6000K | 85 - 265VAC | Ø75mm | Ø95 x Ø51mm | |
| DL-PL15W-6 | 15W | 1350 | | | Ø110mm | Ø140 x Ø62mm | |

Downlight Direcionável duplo



EPISTAR

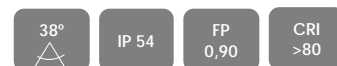

| Referência | Potência | Lumens | Temp. Cor | Voltagem | Corte | Dimensão | Led SMD | Preço |
|---------------|----------|--------|-----------|--------------|----------|------------|---------|-------|
| DL-CL15-213-4 | 15W | 1500 | 4000K | 200 - 265VAC | 72X152mm | 92 x 172mm | 1 | |
| DL-CL15-213-3 | 15W | 1500 | 3000K | | | | | |

Downlight CCT com IP54



| | | | |
|--------------------|-----------------------|--------------------|-------------------------|
| Ângulo Abertura | 120 | CRI | >80 |
| Temperatura de Cor | CCT (3000+4000+6000K) | Índice de Proteção | IP54 |
| Classe de Proteção | Class II | Índice de Impacto | IK08 |
| Voltagem | 170-260V | Factor Potência | >0,5 |
| Material | PC | Certificado | TUV, CE, RoHS, ErP, IEC |

| Referência | Potência | Lumens | Temp. Cor | Voltagem | Corte | Dimensão | Formato | Preço |
|------------|----------|--------|-----------|--------------|--------|------------------|----------|-------|
| DOVE-R5 | 5W | 500 | 3CCT | 170 - 260VAC | Ø75mm | Ø95 x 26mm | Redondo | |
| DOVE-R9 | 9W | 900 | | | Ø110mm | Ø125 x 26mm | | |
| DOVE-R12 | 12W | 1200 | | | Ø125mm | Ø145 x 26mm | | |
| DOVE-R18 | 18W | 1800 | | | Ø150mm | Ø170 x 26mm | | |
| DOVE-R24 | 24W | 2400 | | | Ø205mm | Ø225 x 26mm | | |
| FRAME-R9 | | | | | | Ø125 x 26mm | Redondo | |
| FRAME-R12 | | | | | | Ø145 x 26mm | | |
| FRAME-R18 | | | | | | Ø170 x 26mm | | |
| FRAME-R24 | | | | | | Ø225 x 26mm | | |
| DOVE-S5 | 5W | 500 | 3CCT | 170 - 260VAC | 75mm | 95 x 95 x 26mm | Quadrado | |
| DOVE-S9 | 9W | 900 | | | 110mm | 120 x 120 x 26mm | | |
| DOVE-S12 | 12W | 1200 | | | 130mm | 145 x 145 x 26mm | | |
| DOVE-S18 | 18W | 1800 | | | 145mm | 170 x 170 x 26mm | | |
| DOVE-S24 | 24W | 2400 | | | 205mm | 225 x 225 x 26mm | | |
| FRAME-S9 | | | | | | 120 x 120 x 26mm | Quadrado | |
| FRAME-S12 | | | | | | 145 x 145 x 26mm | | |
| FRAME-S18 | | | | | | 170 x 170 x 26mm | | |
| FRAME-S24 | | | | | | 225 x 225 x 26mm | | |

7

AR-111



AR-111 GU10



| | |
|---------------------|------------------|
| Cor | Branco |
| Ângulo de Abertura | 60 |
| Material | ABS + PS Plastic |
| CRI | 80 |
| Quantidade de Led's | 1 pcs COB |
| Índice de Proteção | IP40 |
| Fator de Potência | 0,9 |

LIFUD
LED Driver
EPISTAR

| Referência | Potência | Lumens | Temp. Cor | Voltagem | Base | Dimensão | Preço |
|------------|----------|--------|-----------|--------------|------|-------------|-------|
| 127/3 | 12W | 1100 | 3000K | 200 - 265VAC | GU10 | Ø111 x 80mm | |
| 127/4 | | | 4000K | | | | |
| 127/6 | | | 6000K | | | | |



| | |
|---------------------|------------------------|
| Cor | Cinza |
| Ângulo de Abertura | 24 |
| Material | Aluminium + PS Plastic |
| CRI | 80 |
| Quantidade de Led's | 2 pcs COB |
| Índice de Proteção | IP40 |
| Fator de Potência | 0,9 |

| Referência | Potência | Lumens | Temp. Cor | Voltagem | Base | Dimensão | Preço |
|------------|----------|--------|-----------|--------------|------|-------------|-------|
| 128/3 | 13W | 1160 | 3000K | 175 - 265VAC | GU10 | Ø111 x 93mm | |

AR-111 G5.3



| | |
|---------------------|------------------------|
| Cor | Cinza |
| Ângulo de Abertura | 45 |
| Material | Aluminium + PS Plastic |
| CRI | 80 |
| Quantidade de Led's | 1 pcs COB |
| Índice de Proteção | IP40 |
| Fator de Potência | 0,9 |

EPISTAR

| Referência | Potência | Lumens | Temp. Cor | Voltagem | Base | Dimensão | Preço |
|------------|----------|--------|-----------|--------------|------|-------------|-------|
| 139/6 | 13W | 1350 | 6000K | 100 - 265VAC | G5.3 | Ø111 x 60mm | |
| 139/3 | | 1250 | 3000K | | | | |

8

PAR 20-30



PAR 20

**Especificações técnicas:**

Material: Alumínio
 Equivalência: 30W Halogéneo
 Cobertura: Acrílico Transparente

EPISTAR

38°

IP 65

FP 0,90

CRI >80

| Referência | Potência | Lumens | Temp. Cor | Voltagem | Base | Dimensão | Led COB | Preço |
|------------|----------|--------|-----------|--------------|------|------------|---------|-------|
| 189/P20W | 8W | 800 | 5000K | 175 - 265VAC | E27 | Ø63 x 82mm | 8 | |
| 189/P20WW | | 720 | 3000K | | | | | |

PAR30

**Especificações técnicas:**

Material: Alumínio
 Equivalência: 50W Halogéneo
 Cobertura: Acrílico Transparente



The Magic of Light™

45°

IP 20

FP 0,90

CRI >80

| Referência | Potência | Lumens | Temp. Cor | Voltagem | Base | Dimensão | Led COB | Preço |
|------------|----------|--------|-----------|-------------|------|-------------|---------|-------|
| 189/P30W | 15W | 1400 | 6000K | 85 - 265VAC | E27 | Ø93 x 101mm | 1 | |

9

RS7

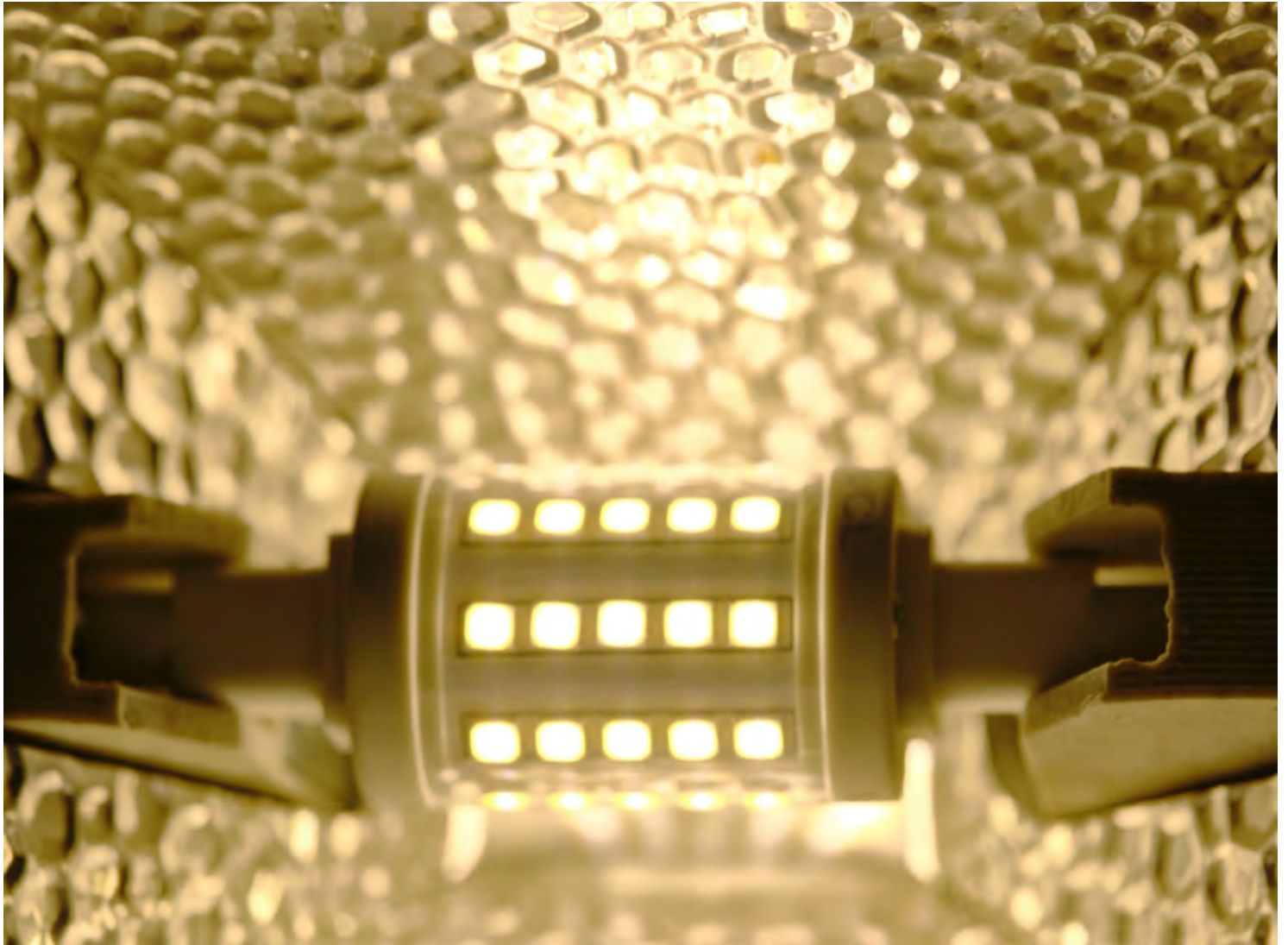

R7S 78mm

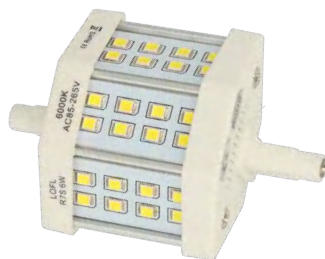
**Especificações técnicas**

Material: Alumínio / Plástico
 Equivalência: 40W Halogéneo
 Cobertura: Não

270°

IP 20

FP
0,62CRI
>80

| Referência | Potência | Lumens | Temp. Cor | Voltagem | Base | Dimensão | Led SMD | Preço |
|------------|----------|--------|-----------|-------------|------|----------------|---------|-------|
| 167/N | 5W | 460 | 6000K | 85 - 265VAC | R7S | 78 x 54 x 35mm | 3014-64 | |
| 168/N | | 400 | 3000K | | | | | |

**Especificações técnicas**

Material: Alumínio / Plástico
 Equivalência: 75W Halogéneo
 Cobertura: Não

270°

IP 20

FP
0,62CRI
>80

| Referência | Potência | Lumens | Temp. Cor | Voltagem | Base | Dimensão | Led SMD | Preço |
|------------|----------|--------|-----------|-------------|------|----------------|---------|-------|
| 167/860 | 8W | 650 | 6000K | 85 - 265VAC | R7S | 78 x 54 x 35mm | 2835-32 | |
| 167/830 | | 600 | 3000K | | | | | |

R7S 118mm

**Especificações técnicas**

Material: Alumínio / Plástico
 Equivalência: 150W Iodetos Metálicos
 Cobertura: Não

270°
IP
40FP
0,95CRI
>80

| Referência | Potência | Lumens | Temp. Cor | Voltagem | Base | Dimensão | Led SMD | Preço |
|------------|----------|--------|-----------|--------------|------|-----------------|---------|-------|
| 075/N | 10W | 850 | 6000K | 200 - 265VAC | R7S | 118 x 54 x 35mm | 3014-90 | |
| 076/N | | 780 | 3000K | | | | | |
| 075/D | | 850 | 6000K | | | | | |

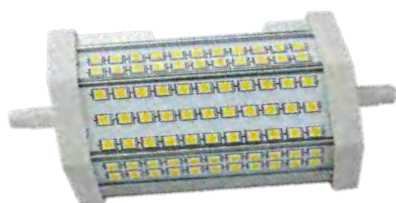
**Especificações técnicas**

Material: Alumínio / Plástico
 Equivalência: 300W Halogéneo
 Cobertura: Não

270°
IP
40FP
0,95CRI
>80

| Referência | Potência | Lumens | Temp. Cor | Voltagem | Base | Dimensão | Led SMD | Preço |
|------------|----------|--------|-----------|--------------|------|-----------------|---------|-------|
| 075/860 | 16W | 1450 | 6000K | 200 - 265VAC | R7S | 118 x 45 x 40mm | 2835-77 | |
| 075/840 | | 1400 | 4000K | | | | | |



Especificações técnicas

Material: Alumínio / Plástico
 Equivalência: 150W Halógeno
 Cobertura: Plástico

360°



IP

40

FP

0,90

CRI

>80

| Referência | Potência | Lumens | Temp. Cor | Voltagem | Base | Dimensão | Led SMD | Preço |
|------------|----------|--------|-----------|--------------|------|-------------|---------|-------|
| 075/380.84 | 10W | 1150 | 4000K | | | | | |
| 075/118-6 | | 2200 | 6000K | 200 - 265VAC | R7S | Ø25 x 118mm | 2835-96 | |
| 075/118-4 | 18W | 2200 | 4000K | | | | | |
| 075/118-3 | | 2100 | 2700K | | | | | |

R7S 135mm



Especificações técnicas

Material: Alumínio / Plástico
 Equivalência: 150W Iodetos Metálicos
 Cobertura: Não

360°



IP

40

FP

0,90

CRI

>80

| Referência | Potência | Lumens | Temp. Cor | Voltagem | Base | Dimensão | Led SMD | Preço |
|------------|----------|--------|-----------|--------------|------|-------------|----------|-------|
| 075/135-6 | 14W | 1600 | 6000K | 200 - 265VAC | R7S | Ø22 x 135mm | 2835-120 | |
| 075/135-3 | | 1500 | 3000K | | | | | |



10

PLC

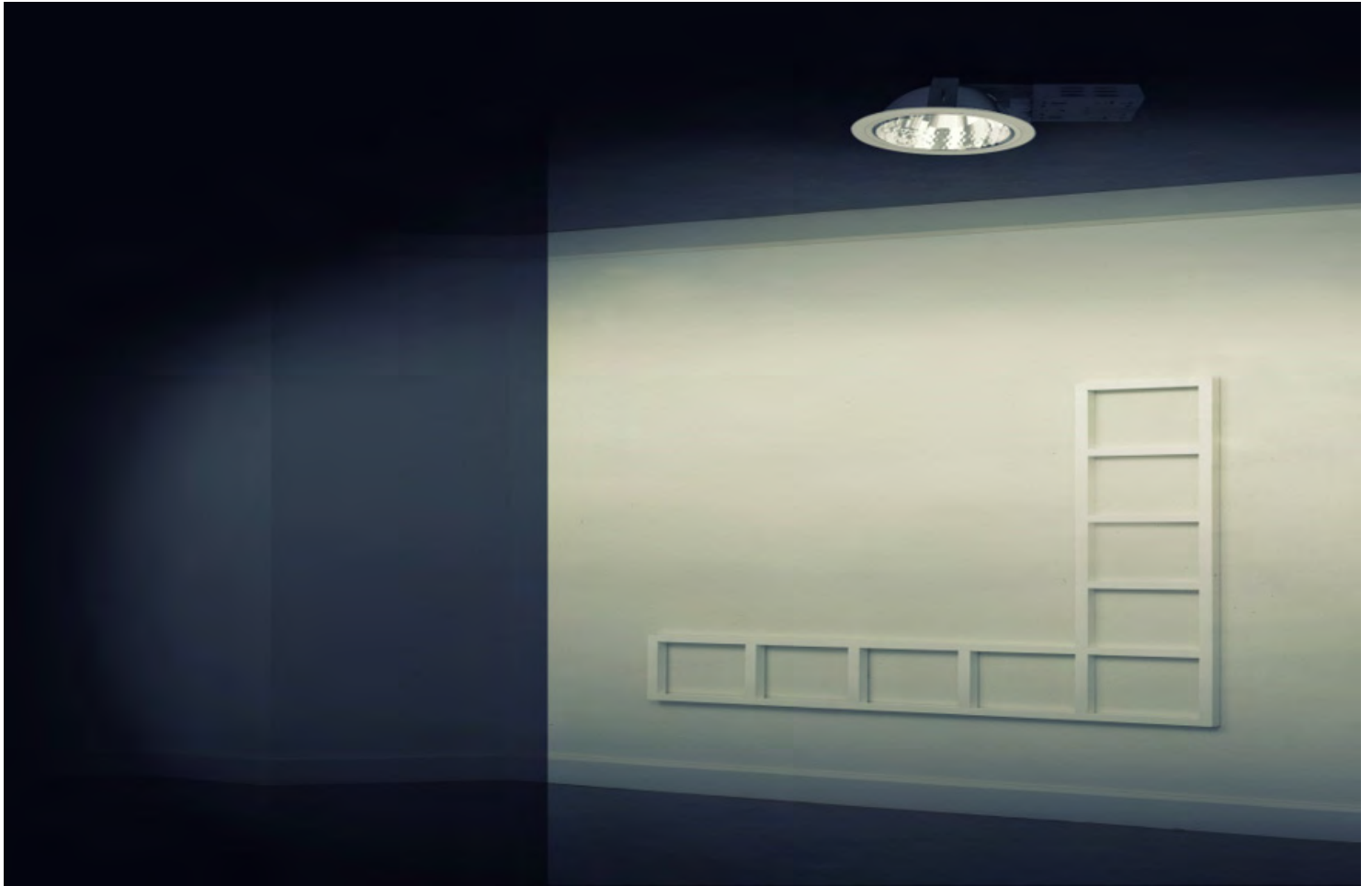

PLC G24

Especificações técnicas

Material: Alumínio
 Cobertura: Sim

120°

IP 20

FP
0,95CRI
>80

| Referência | Potência | Lumens | Temp. Cor | Voltagem | Base | Dimensão | Led SMD | Preço |
|------------|----------|--------|-----------|-------------|------|------------|---------|-------|
| 104/840 | 7W | 700 | 4000K | 85 - 265VAC | G24 | 144 x 34mm | 2835-40 | |
| 104/860 | | | 6000K | | | | | |
| 146/840 | 12W | 1200 | 4000K | | | | | |
| 146/860 | | | 6000K | | | | | |

Especificações técnicas

Material: Alumínio
 Equivalência: ECO 18W
 Cobertura: Não

120°

IP 20

FP
0,95CRI
>80

| Referência | Potência | Lumens | Temp. Cor | Voltagem | Base | Dimensão | Led SMD |
|------------|----------|--------|-----------|-------------|------|-----------------|---------|
| 131/G24 | 10W | 870 | 3000K | 85 - 265VAC | G24 | 145 x 35 x 35mm | 2835-48 |
| 146/830 | 12W | 1270 | | | | 160 x 35 x 35mm | 2835-60 |
| 147/N | 13W | 1150 | | | | 3014-120 | |



11

T5 / T8 / Tri Proof

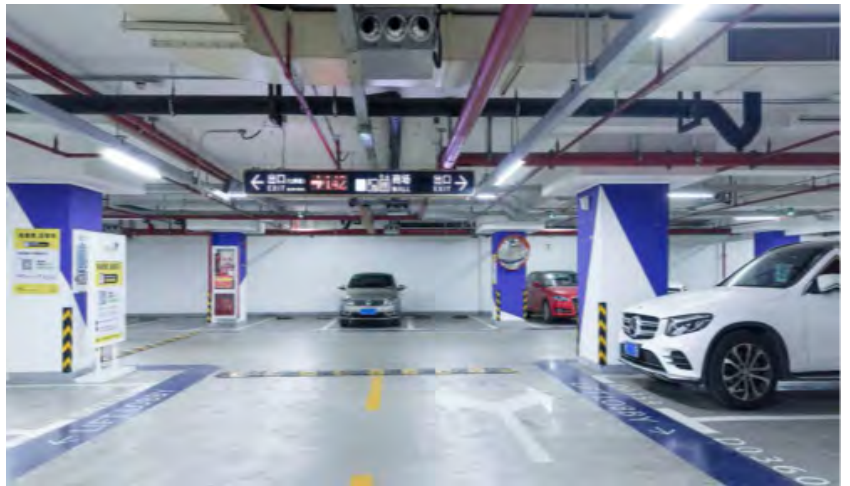

T5 60 / 90 / 120

**Especificações técnicas**

Material: Alumínio / Plástico
Base: T5

120°



IP 44

FP
0,90CRI
>80

Obs: Inclui topo, união e fixador.

| Referência | Potência | Lumens | Temp. Cor | Voltagem | Cobertura | Dimensão | Led SMD |
|--------------------|------------|--------|----------------|--------------|-----------|------------------|---------|
| 161+ 162+ | 9W | 900 | 4000K 6000K | | | 600 x 22 x 33mm | 2835-48 |
| 161/90 162/90 | 14W 12W | 1100 | 4000K 6000K | 175 - 265VAC | Opalina | 900 x 22 x 33mm | 2835-72 |
| 161/120 162/120 | 18W | 1800 | 4000K 6000K | | | 1200 x 22 x 33mm | 2835-96 |

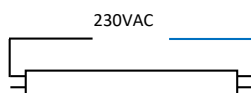
T8 45 / 90 / 100

**Especificações técnicas**

Material: Alumínio / Plástico
Base: T8

120°

IP 44

FP
0,90CRI
>80

| Referência | Potência | Lumens | Temp. Cor | Voltagem | Cobertura | Dimensão | Led SMD | Preço |
|------------|----------|--------|-----------|-------------|--------------|-------------|---------|-------|
| 150/45PWR | 7W | 675 | 4000K | 85 - 265VAC | Transparente | Ø26 x 450mm | 2835-36 | |

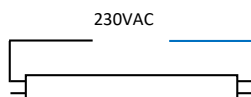
**Especificações técnicas**

Material: Alumínio / Plástico
Base: T8

120°

IP 44

FP
0,90CRI
>80

| Referência | Potência | Lumens | Temp. Cor | Voltagem | Cobertura | Dimensão | Led SMD | Preço |
|----------------------|----------|--------|-----------|-------------|-------------------------|-------------|---------|-------|
| 150/860 150/860OP | 14W | 1400 | 6000K | 85 - 265VAC | Transparente Opalina | Ø26 x 900mm | 2835-72 | |

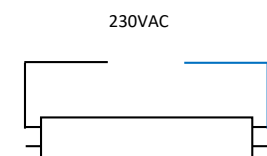
**Especificações técnicas**

Material: Alumínio / Plástico
Base: T8

120°



IP 44

FP
0,90CRI
>80

Obs: Lâmpada c/ topos rotativos.

| Referência | Potência | Lumens | Temp. Cor | Voltagem | Cobertura | Dimensão | Led SMD | Preço |
|------------|----------|--------|-----------|-------------|-----------|--------------|---------|-------|
| 150/WR | 14W | 1500 | 6000K | 85 - 265VAC | Opalino | Ø26 x 1000mm | 2835-80 | |

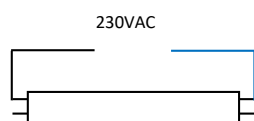
T8 60 / 120 / 150

**Especificações técnicas**

Material: Alumínio / Plástico
Base: T8

120°

IP 44

FP
0,90CRI
>80

| Referência | Potência | Lumens | Temp. Cor | Voltagem | Cobertura | Dimensão | Led SMD |
|------------|----------|--------|-----------|-------------|--------------|--------------|----------|
| 151/C+ | 9W | 1150 | 6000K | 85 - 265VAC | Transparente | Ø26 x 600mm | 3014-96 |
| 151/OP+ | | 1150 | 4000K | | Opalina | | |
| 152/OP+ | | 1000 | 4000K | | Opalina | | |
| 153/C+ | 18W | 2200 | 6000K | | Transparente | Ø26 x 1200mm | 3014-192 |
| 154/C+ | | 2050 | 3000K | | | | |
| 154/OP+ | | 2050 | 3000K | | Opalina | | |
| 155/C+ | 22W | 2880 | 6000K | 85 - 265VAC | Transparente | Ø26 x 1500mm | 3014-240 |
| 156/C+ | | 2400 | 3000K | | Opalina | | |
| 155/OP+ | | 2880 | 6000K | | | Opalina | |
| 156/OP+ | | 2400 | 3000K | | Opalina | | |

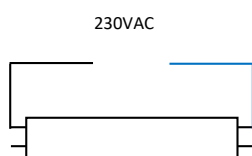
**Especificações técnicas**

Material: Alumínio / Plástico
Base: T8

120°

IP 44

FP
0,90CRI
>80

Obs: Designação "R" Lâmpada com topos rotativos.

| Referência | Potência | Lumens | Temp. Cor | Voltagem | Cobertura | Dimensão | Led SMD | Preço | |
|------------|----------|--------|-----------|-------------|--------------|--------------|--------------|----------|--|
| 151/860 | 9W | 900 | 6000K | 85 - 265VAC | Transparente | Ø26 x 600mm | 2835-48 | | |
| 151/840 | | 800 | 4000K | | | | | | |
| 151/860R | | 900 | 6000K | | | | | | |
| 151/840R | | 800 | 4000K | | | | | | |
| 151/860OP | Opalina | 900 | 6000K | | | | | | |
| 151/840OP | | 800 | 4000K | | | | | | |
| 153/860 | 18W | 1800 | 6000K | | 85 - 265VAC | Transparente | Ø26 x 1200mm | 2835-104 | |
| 153/840 | | 1600 | 4000K | | | | | | |
| 153/860R | | 1800 | 6000K | | | | | | |
| 153/840R | | 1600 | 4000K | | | | | | |
| 153/860OP | | 1800 | 6000K | | | | | | |
| 153/840OP | | 1600 | 4000K | | | | | | |
| 155/860 | 22W | 2300 | 6000K | 85 - 265VAC | Transparente | Ø26 x 1500mm | 2835-120 | | |
| 155/840 | | 2100 | 4000K | | | | | | |
| 155/840R | | 2100 | 4000K | | | | | | |
| 155/860OP | | 2300 | 6000K | | | | | | |
| 155/840OP | | 2100 | 4000K | | | | | | |
| 155/840OP | | 2100 | 4000K | | | | | | |



Especificações técnicas

Material: Alumínio / Plástico
Base: T8

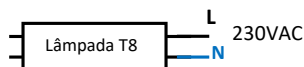

Obs: Lâmpada com topos rotativos. Ligação num dos topos.



| Referência | Potência | Lumens | Temp. Cor | Voltagem | Cobertura | Dimensão | Led SMD | Preço |
|--------------------------|----------|--------------|----------------|-------------|-----------|--------------|----------|-------|
| 151/ECO6-R 151/ECO4-R | 9W | 900 850 | 6000K 4000K | 85 - 265VAC | Opalina | Ø32 x 600mm | 2835-48 | |
| 153/ECO6-R 153/ECO4-R | 18W | 1900 1800 | 6000K 4000K | | | | | |
| 155/ECO6-R 155/ECO4-R | 22W | 2300 2200 | 6000K 4000K | | | Ø26 x 1500mm | 2835-120 | |

T8 60 / 120 / 150 Especiais

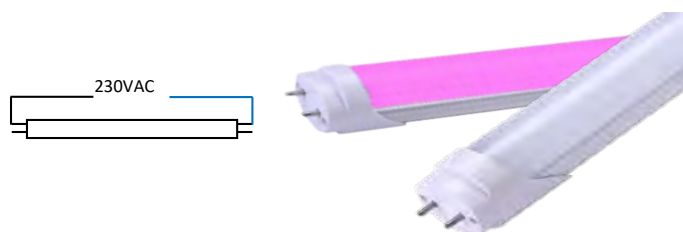

Especificações técnicas

Material: Alumínio / Plástico
Base: T8

Obs: Própria para colocar em vitrines de talhos, peixaria, fruta, pastelaria. Temperatura de trabalho -40° a 50°C



| Referência | Potência | Lumens | Temp. Cor | Voltagem | Cobertura | Dimensão | Led SMD | Preço |
|---|----------|--------|---------------------------------|-------------|-----------|--------------|----------|-------|
| 151/MEAT 151/FISH 151/PAST 151/VEG | 9W | 850 | PINK 6000K 2700K 4000K | 85 - 265VAC | Opalina | Ø32 x 600mm | 2835-48 | |
| 153/MEAT 153/FISH 153/PAST 153/VEG | 18W | 1700 | PINK 6000K 2700K 4000K | | | | | |
| 155/MEAT 155/FISH 155/PAST 155/VEG | 22W | 2200 | PINK 6000K 2700K 4000K | | | Ø26 x 1500mm | 2835-132 | |

Triproof 60 / 120 / 150 com IP65



Especificações técnicas

Material: Alumínio / Plástico
Temperatura de Trabalho: 50°C ~30°C

Obs: Fornecido com kit de fixação.



| Referência | Potência | Lumens | Temp. Cor | Voltagem | Cobertura | Dimensão | Led SMD | Preço |
|------------|----------|--------|-----------|-------------|-----------|------------------|----------|-------|
| 151/TRI6 | 20W | 1640 | | | | 630 x 70 x 80mm | 2835-120 | |
| 153/TRI6 | 40W | 3800 | 6000K | | | | | |
| 153/TRI6N | 35W | 4120 | | 85 - 265VAC | Opalina | 1230 x 70 x 80mm | 2835-224 | |
| 153/TRI4 | 40W | 3800 | 4000K | | | | | |
| 155/TRI6 | 50W | 4263 | 6000K | | | | | |
| 155/TRI4 | 50W | 4162 | 4000K | | | 1530 x 70 x 80mm | 2835-288 | |

Réguas

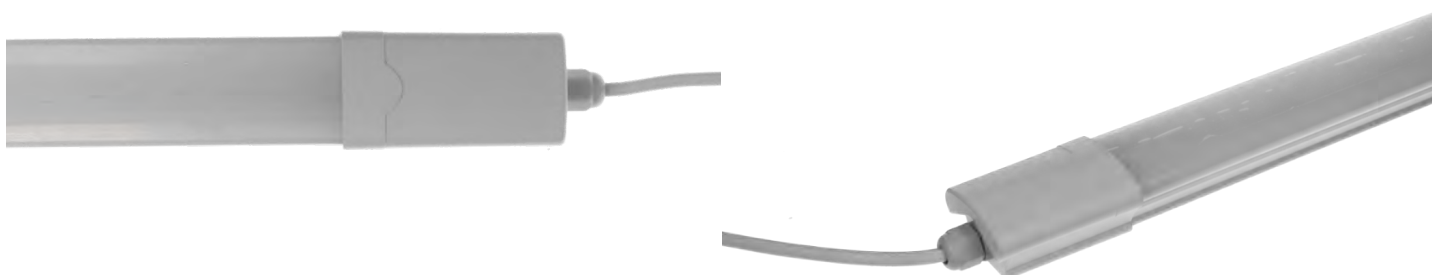

| Referência | Potência | Lumens | Temp. Cor | Voltagem | Cobertura | Dimensão | Preço |
|------------|----------|--------|-----------|-------------|-----------|----------|-------|
| REG/BTL18 | 18W | 1530 | | | | 610mm | |
| REG/BTL36 | 36W | 3060 | 4000K | 85 - 265VAC | Opalina | 1200mm | |
| REG/BTL42 | 42W | 3570 | | | | 1500mm | |

12

Armaduras de Emergência



Armaduras de Emergência



Especificações Técnicas

Modo: Permanente / Não-Permanente
 Bateria: Nickel-Cadmium 3.6V /1.8 Ah
 Indicador: Red LED - charging; Green LED - AC power
 Tempo duração: 3 horas
 Construção: Fire-Retardant ABS Casing and Plate; PC Diffuser
 Instalação: Superfície

| Referência | Potência | Lumens | Temp. Cor | Voltagem | IP | Dimensão | Led SMD | Preço |
|------------|----------|--------|-----------|--------------|----|------------------|---------|-------|
| EM121N | 3W | 200 | 6000k | 220 - 240VAC | 65 | 262 x 100 x 46mm | 5730-6 | |



Especificações Técnicas

Modo: Não-Permanente
 Bateria: Nickel-Cadmium 3.6V /1.8 Ah
 Indicador: Red LED - charging; Green LED - AC power
 Tempo de duração: 3 horas
 Construção: Fire-Retardant ABS Casing and Plate; PC Diffuser
 Instalação: Superfície

| Referência | Potência | Lumens | Temp. Cor | Voltagem | IP | Dimensão | Led SMD | Preço |
|------------|----------|--------|-----------|--------------|----|-----------------|---------|-------|
| EM116N-A1 | 3W | 200 | 6000k | 200 - 240VAC | 40 | 238 x 80 x 40mm | 5730-6 | |



Especificações Técnicas

Modo: Permanente
 Bateria: Nickel-Cadmium 3.6V /1.0Ah
 Indicador: Green LED- Charging
 Tempo de duração: Mais de 3 horas
 Construção: Aluminum body, Acrylic Plate
 Instalação: Superfície & Suspenso

| Referência | Potência | Lumens | Temp. Cor | Voltagem | IP | Dimensão | Led SMD | Preço |
|------------|----------|--------|-----------|------------|----|------------------|---------|-------|
| EM211M | 3W | 200 | 6000k | 200-240VAC | 20 | 310 x 225 x 35mm | 2835-15 | |

13

Lâmpadas de Piscina



TYPE 316
Stainless Steel

PAR 56

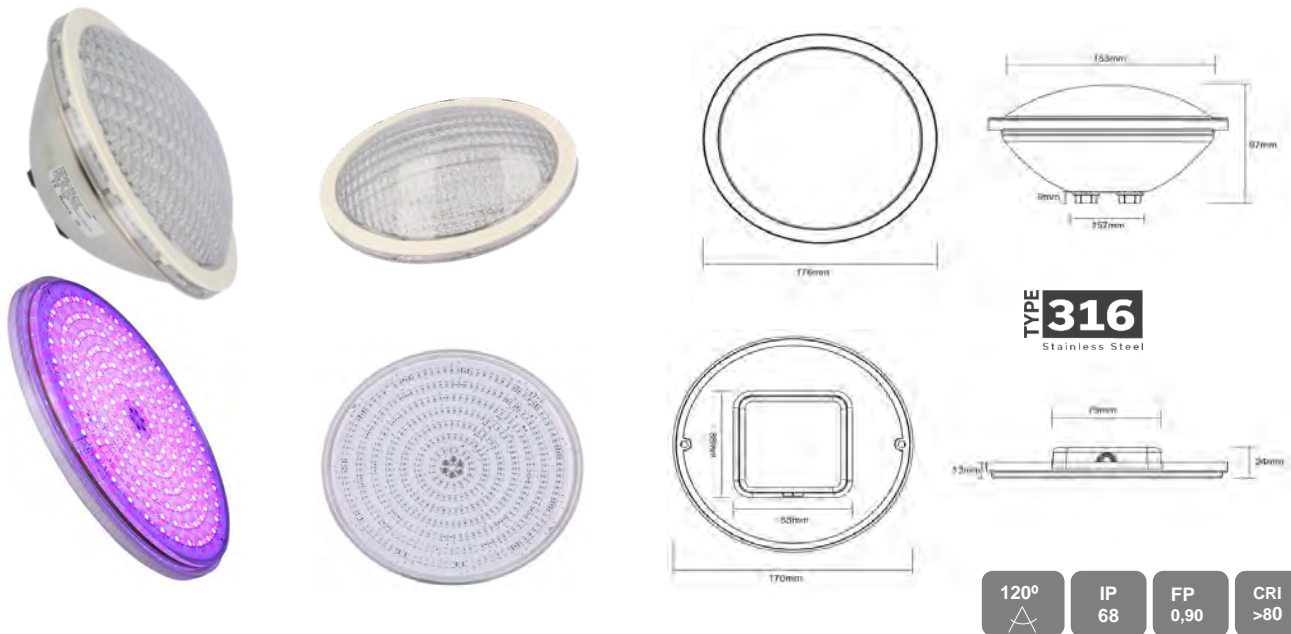

Modelo
UT
Ultra Thin

| Referência | Potência | Temp. Cor | Lumens | Voltagem | Base | Funcionamento | LED | Preço |
|----------------------------|----------|-----------|--------------|----------|-------|---------------|----------|-------|
| P56/35-6 | 35W | 6000K | 3500 | 12VAC/DC | PAR56 | 2 - FIOS | COB -1 | |
| P56/25-6 | 25W | 6000K | 2500 | | | PL- RGB | SMD 2835 | |
| P56/25-RGB P56/UT25-RGB | | | R G B | 750-850 | | | | |

SPL

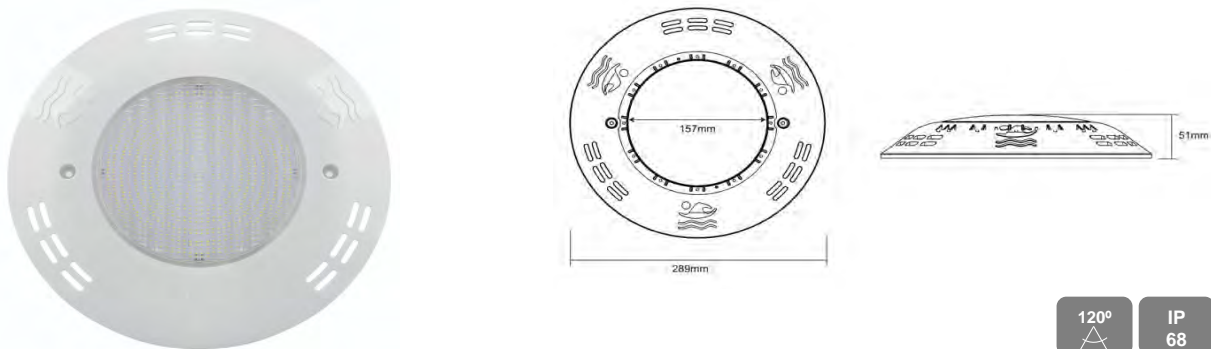

| Referência | Potência | Temp. Cor | Lumens | Voltagem | Base | Funcionamento | LED | Preço |
|------------|----------|--------------|--------|----------|------------|---------------|------|-------|
| SPL/15-RGB | 15W | R G B | | 12VAC/DC | Superfície | PL- RGB | 2835 | |
| SPL/30-6 | 30W | 6000K | 2500 | | | 2 - FIOS | | |
| SPL/15-6 | 15W | | 1250 | | | | | |

SPA



| Referência | Potência | Temp. Cor | Lumens | Voltagem | Base | Funcionamento | LED | Preço |
|------------|----------|--------------|--------|----------|------|---------------|-----------|-------|
| SPA/3-6 | 3W | 6000K | 350 | 12VAC/DC | | 2 - FIOS | 36 - 2835 | |
| SPA/3-RGB | | R G B | 320 | | | 4 - FIOS | | |

Controlador RGB Piscina



Referência
PL-RGB

Voltagem
12V AC/DC

Preço

Habitáculo para PAR 56



Obs: Compatível com os modelos PAR56. Com IP68.

Referência
HAB/PAR-C
HAB/PAR-V

Utilização
Concreto
Vinil

Material
ABS

Cabo Alimentação
2 x 1,5mm, L=1,5mt

Dimensão
Ø290 x 165mm

Preço

Projetores Lago Inox



Especificações técnicas:

Material: Inox 316
Tempo de vida: 30.000H
Cobertura: Transparente

TYPE 316
Stainless Steel
EPISTAR

60°



IP

68

FP

0,90

CRI

>80

| Referência | Potência | Lumens | Temp. Cor | Voltagem | Ligação | Dimensão | Led | Preço |
|------------|----------|--------|-----------|----------|---------|--------------|-----|-------|
| 098/3W | 3W | 250 | 6000K | 12V DC | 2 FIOS | Ø125 x 115mm | 3 | |
| 098/6W | 6W | 400 | | | | | | |
| 098/9W | 9W | 990 | | | | | | |
| 098/9RGB | | 489 | | | | | | |

Projektor Chão Inox



TYPE 316
Stainless Steel
EPISTAR

60°
IP 67
FP 0,90
CRI >80

| Referência | Potência | Lumens | Temp. Cor | Voltagem | Base / Corte | Dimensão | Led | Preço |
|------------|----------|--------|-----------|----------|--------------|--------------|------|-------|
| 099/3-3 | 3W | 300 | 3000K | 230V AC | Ø | Ø55 x 82mm | 1 | |
| 099/12W | 12W | 1320 | 6000K | 12V DC | Ø154 x 92mm | Ø170 x 95mm | 12*1 | |
| 099/54W | 54W | 5200 | | 24V DC | Ø220 x 135mm | Ø220 x 135mm | 18*3 | |
| 099/3RGB | 3W | | R G B | 12V DC | Ø70 x 85mm | Ø90 x 90mm | 3*1 | |



304
STAINLESS STEEL
EPISTAR



Rotation angle of light plate ±15°



10°
IP 68
FP 0,90
CRI >80

| Referência | Potência | Lumens | Temp. Cor | Voltagem | Base / Corte | Dimensão | Led | Preço |
|------------|----------|--------|-----------|----------|--------------|--------------|-----|-------|
| 100/3-3 | 3W | 300 | 3000K | 230V | Ø105 x 140mm | Ø120 x 140mm | 1 | |

Projektor Exterior Inox IP 67

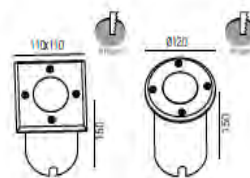

304
STAINLESS STEEL

| Referência | IP | IK | Temp. de Funcionamento | Voltagem | Corte | Dimensão | Preço |
|------------|----|----|------------------------|---------------|--------------|--------------------|-------|
| FL-GU10R | 67 | 10 | -40° ~ 45° | 100 - 240 VAC | Ø105 | Ø120 x A150mm | |
| FL-GU10Q | | | | | Ø105 x 105mm | 110 x 110 x A150mm | |

14

Projetores de Exterior

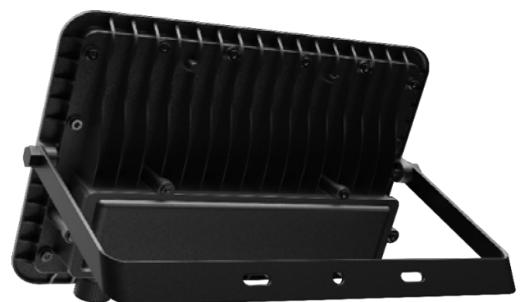

Projetores SMD



Especificações Técnicas

Material: Alumínio
 Tempo de vida: 30.000H
 Cobertura: Vidro
 Tipo drive: Interno



| Referência | Potência | Lumens | Temp. Cor | Voltagem | IP | Dimensão | Led SMD | Preço |
|-------------------------------|----------|----------------|----------------|--------------|----|-------------------|----------|-------|
| 057/ALSMD-6 | 10W | 860 | 6000K | 100 - 265VAC | 65 | 112 x 84 x 41mm | 2835-20 | |
| 059/ALSMD-6 060/ALSMD-3 | 30W | 2923 2800 | 6000K 3000K | | | 186 x 225 x 53mm | 2835-60 | |
| 150W/ALSMD-6 150WW/ALSMD-3 | 150W | 12508 12360 | 6000K 3000K | | | 395 x 280 x 160mm | 2835-300 | |
| 200WW/ALSMD-3 | 200W | 16320 | 3000K | | | 425 x 323 x 160mm | 2835-400 | |



Especificações Técnicas

Material: Alumínio
 Tempo de vida: 30.000H
 Cobertura: Vidro
 Tipo drive: Interno



| Referência | Potência | Lumens | Temp. Cor | Voltagem | IP | Dimensão | Led SMD | Preço |
|----------------------------------|----------|----------------|----------------|--------------|----|------------------|----------|-------|
| 057/ALSMD-6N 058/ALSMD-3N | 10W | 860 710 | 6000K 3000K | 175 - 265VAC | 65 | 112 x 84 x 41mm | 5630-20 | |
| 063/ALSMD-6N 063/ALSMD-3N | 20W | 1600 | 6000K 3000K | | | 115 x 87 x 28mm | 5630-40 | |
| 059/ALSMD-6N 060/ALSMD-3N | 30W | 2923 2800 | 6000K 3000K | | | 135 x 175 x 34mm | 5630-60 | |
| 061/ALSMD-6N 062/ALSMD-3N | 50W | 4505 4355 | 6000K 3000K | | | 220 x 180 x 35mm | 5630-100 | |
| 100W/ALSMD-6N 100WW/ALSMD-3N | 100W | 8589 8489 | 6000K 3000K | | | 275 x 225 x 45mm | 5630-200 | |
| 200W/ALSMD-6-N 200W/ALSMD-3-N | 200W | 16472 16320 | 6000K 3000K | | | 425 x 325 x 75mm | 5630 400 | |

Projetores brancos SMD



Especificações Técnicas

Material: Alumínio
 Tempo de vida: 30.000H
 Cobertura: Vidro
 Tipo drive: Interno



Obs: Alumínio Lacado branco.

| Referência | Potência | Lumens | Temp. Cor | Voltagem | IP | Dimensão | Led SMD | Preço |
|--------------------------------|----------|--------|----------------|--------------|----|------------------|----------|-------|
| 057/ALSMD-6-B 058/ALSMD-3-B | 10W | 800 | 6000K 3000K | 220 - 240VAC | 65 | 112 x 84 x 41mm | 5630-20 | |
| 063/ALSMD-6-B 063/ALSMD-3-B | 20W | 1600 | 6000K 3000K | | | 115 x 87 x 28mm | 5630-40 | |
| 059/ALSMD-6-B 060/ALSMD-3-B | 30W | 2400 | 6000K 3000K | | | 135 x 175 x 34mm | 5630-60 | |
| 061/ALSMD-6-B 062/ALSMD-3-B | 50W | 4000 | 6000K 3000K | | | 220 x 180 x 35mm | 5630-100 | |
| 100W/ALSMD-6B | 100W | 8000 | 6000K | | | 275 x 225 x 45mm | 5630-200 | |
| 200W/ALSMD-6B | 200W | 16472 | 6000K | | | 425 x 325 x 75mm | 5630 400 | |

Projetores SMD UGR<19 - Anti Reflexo

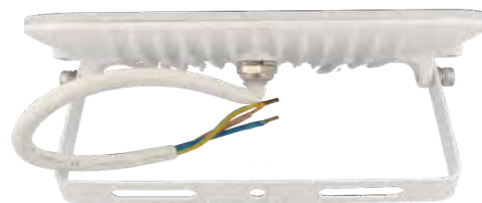

| | | | |
|--------------------|-------------------------------|--------------------|-------|
| Ângulo Abertura | 120 | CRI | 80 |
| Classe de Proteção | Class I | Índice de Proteção | IP65 |
| Material | Alumínio / Vidro Anti-Encand. | Índice de Impacto | IK 08 |
| Certificado | TUV, CE, RoHS, ErP, IEC | Factor Potência | >0,9 |

| Referência | Potência | Lumens | Temp. Cor | Voltagem | IP | Dimensão | Led SMD |
|------------------------------------|----------|--------|----------------|------------|----|--------------------|---------|
| 057/ALSMD-6-BAR 058/ALSMD-3-BAR | 10W | 1000 | 6000K 3000K | 200-265VAC | 65 | 118 x 85 x 20,5mm | 2835-15 |
| 059/ALSMD-6-BAR | 30W | 3000 | 6000K | | | 193 x 138 x 20,5mm | 2835-45 |
| 061/ALSMD-6-BAR 062/ALSMD-3-BAR | 50W | 5000 | 6000K 3000K | | | 235 x 165 x 20,5mm | 2835-70 |

Projetor RGB + CCT



| Referência | Potência | Temp. Cor | Voltagem | IP | Dimensão | Led SMD | Preço |
|---------------|----------|------------|------------|----|------------------|---------|-------|
| 30W/ALSMD-RGB | 30W | R G B +CCT | 160-265VAC | 65 | 150 x 181 x 27mm | 2835-60 | |

Projetores SMD UGR<19 Anti Reflexo c/ Sensor Movimento PIR

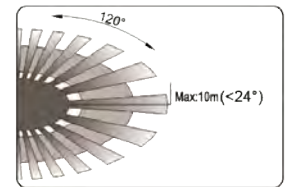
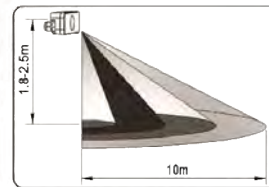
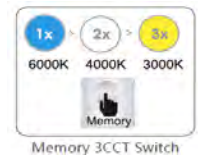
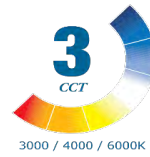

| | | | |
|--------------------|-------------------------------|--------------------|-------|
| Ângulo Abertura | 120 | CRI | >80 |
| Classe de Proteção | Class I | Índice de Proteção | IP65 |
| Material | Alumínio / Vidro Anti-Encand. | Índice de Impacto | IK 08 |
| Certificado | TUV, CE, RoHS, ErP,IEC | Factor Potência | >0,9 |

Altura de Instalação: 1,8-2,5m Distância de detecção: Max.10Mt

| Referência | Potência | Lumens | Temp. Cor | Voltagem | Sensor | Dimensão | Led SMD | Preço |
|------------|----------|--------|-----------|--------------|--------|------------------|---------|-------|
| 057/SP-CCT | 10W | 1000 | 3CCT | 200 - 265VAC | PIR | 118 x 85 x 25mm | 2835-30 | |
| 059/SP-CCT | 30W | 3000 | | | | 195 x 164 x 31mm | 2835-90 | |

Projektor de Trabalho a Bateria



| | |
|--------------------|----------------------------|
| Ângulo Abertura | 120 |
| Classe de Proteção | Class I |
| Material | Alumínio / Vidro Temperado |
| Certificado | TUV, CE, RoHS, ErP,IEC |
| CRI | 80 |
| Índice de Proteção | IP54 |
| Índice de Impacto | IK 08 |
| Factor Potência | >0,9 |

Funcionamento

50% luz: 6 Horas

100% luz: 4 Horas

Vermelho * Azul Luz de Aviso

| Referência | Potência | Lumens | Temp. Cor | Bateria | Carregamento | Dimensão | USB | Preço |
|------------|----------|--------|-----------|----------|--------------|-------------------|-------|-------|
| FL-10W-6 | 10W | 900 | 6000K | 10000mAH | 11 Horas | 235 x 150 x 225mm | DC 5V | |

Projetores Policarbonato



Especificações Técnicas

| | |
|----------------|-----------|
| Material: | Alumínio |
| Tempo de vida: | 30.000H |
| Cobertura: | Vidro |
| Equivalência: | Halogéneo |



| Referência | Potência | Lumens | Temp. de Cor | Voltagem | IP | Dimensão | Led COB | Preço |
|------------|----------|--------|--------------|--------------|----|------------------|---------|-------|
| 057/PLB | 10W | 1200 | 6000K | 200 - 265VAC | 65 | 133 x 179 x 57mm | 1 | |
| 058/PLB | | 1100 | 3000K | | | 178 x 215 x 81mm | | |
| 059/PLB | 30W | 3600 | 6000K | | | | | |



Especificações Técnicas

| | |
|----------------|--------------|
| Material: | Vidro |
| Tempo de vida: | 30.000H |
| Cobertura: | Transparente |



| Referência | Potência | Temperatura de Cor | Voltagem | IP | Dimensão | Led COB | Preço |
|------------|----------|----------------------------|--------------|----|------------------|---------|-------|
| 178/30PLM | 30W | R G B | 200 - 265VAC | 65 | 178 x 215 x 81mm | 1 | |

Projetores Alumínio



| | | | |
|--------------------|-------------------------|--------------------|-------|
| Ângulo Abertura | 90 | CRI | >80 |
| Classe de Proteção | Class I | Índice de Proteção | IP65 |
| Material | Alumínio / Lentes em PC | Índice de Impacto | IK 08 |
| Certificado | TUV, CE, RoHS, ErP,IEC | Factor Potência | >0,9 |

| Referência | Potência | Lumens | Temp. Cor | Voltagem | Dimensão | Led SMD | Preço |
|------------|----------|--------|-----------|------------|--------------------|---------|-------|
| FL-AK30W-6 | 30W | 3000 | 6000k | 175-265VAC | 167 x 128 x 18,5mm | 2835-66 | |
| FL-AK50W-6 | 50W | 5000 | | | 208 x 160 x 22,5mm | | |



| | | | |
|--------------------|-------------------------|--------------------|-------|
| Ângulo Abertura | 90 | CRI | >80 |
| Classe de Proteção | Class I | Índice de Proteção | IP65 |
| Material | Alumínio / Lentes em PC | Índice de Impacto | IK 08 |
| Certificado | TUV, CE, RoHS, ErP,IEC | Factor Potência | >0,9 |

| Referência | Potência | Lumens | Temp. Cor | Voltagem | Dimensão | Led SMD | Preço |
|--------------|----------|--------|-----------|------------|--------------------|---------|-------|
| FL-DK50W-CCT | 50W | 5000 | CCT | 175-265VAC | 210 x 160 x 43,6mm | 2835-84 | |

Projetor a Bateria

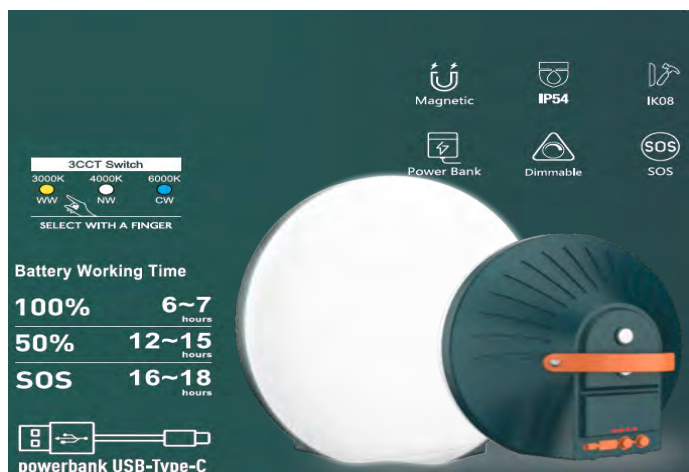

| | |
|--------------------|----------------------------|
| Ângulo Abertura | 120 |
| Classe de Proteção | Class I |
| Material | Alumínio / Vidro Temperado |
| Certificado | TUV, CE, RoHS, ErP,IEC |
| CRI | 80 |
| Índice de Proteção | IP54 |
| Índice de Impacto | IK 08 |
| Factor Potência | >0,9 |



| Referência | Potência | Lumens | Temp. Cor | Bateria | Carregamento | Dimensão | USB | Preço |
|------------|----------|--------|-----------|----------|--------------|------------------|-------|-------|
| FAAS7 | 7W | 1200 | CCT | 7800mAH | 10 Horas | 175 x 175 x 67mm | DC 5V | |
| FAAS12 | 12W | 1800 | | 10400mAH | | 205 x 205 x 73mm | | |

15

Projetores de Estádio



| | | | |
|-----------------|----------------|---------------------|-------|
| Ângulo Abertura | 90° | CRI | 80 |
| Material | Pure Aluminium | Índice de Protecção | IP67 |
| Certificado | CE, RoHS | Fator Potência | >0,95 |

| Referência | Potência | Lumens | Temp. Cor | Voltagem | Dimável | Preço | |
|------------|----------|---------|-----------|-----------|---------|-------|---------------|
| LE-5-600W | 600W | 90 000 | 5000K | 90-305VAC | sim | | Disponível |
| LE-5-1000W | 900W | 135 000 | 6000K | | | | Por Encomenda |

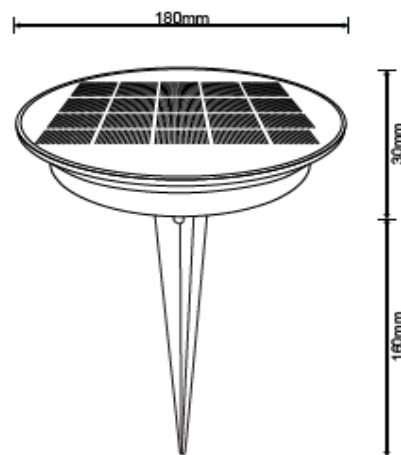

Led Jardim 1 x GU10



| Referência | Potência | Base | IP | Material | Preço |
|------------|--------------------|------|----|-------------------------------------|-------|
| GL-6002 | 220 - 240V Max.35W | GU10 | 65 | 316 Stainless steel, Tempered glass | |

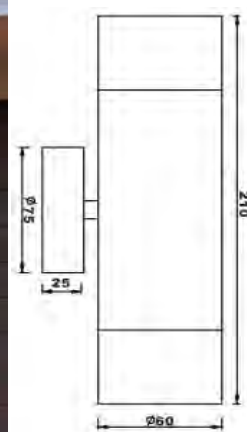

| Referência | Potência | Base | IP | Material | Preço |
|------------|--------------------|------|----|-------------------------------------|-------|
| GL-6001 | 220 - 240V Max.35W | GU10 | 65 | 316 Stainless steel, Tempered glass | |

Led Jardim

Especificações técnicas

Material: Alumínio
Tipo drive: Interno



| Referência | Potência | Lumens | Temp. Cor | Voltagem | Base | Dimensão | LED | Preço |
|------------|----------|--------|-----------|-------------|------|--------------|-------|-------|
| 685/W | 3W | 300 | 6000K | 85 - 265VAC | Cabo | Ø75 x L250mm | COB-1 | |



GL-803A

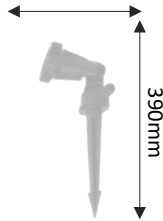

GL-0481

Potência
Voltagem
Base

Até 35W
210-265V
GU10



Índice de Proteção
Cor
Certificado

IP 65
Preto
CE, RoHS,ErP

| Referência | Material | Dimensão | Preço |
|------------|---------------------|--------------|-------|
| GL-803A | Nylon + Plastic | 78 x 390mm | |
| GL-0481 | Aluminium + Plastic | 65 x 268,5mm | |

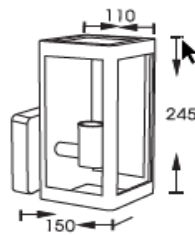

Material: Die-Cast Aluminium + PC Lens
Base: E27
Índice de Proteção: IP 65
Cor: Cinzento Escuro
Certificado: CE, RoHS,ErP



Lâmpada de Filamento E27 incluída

| Referência | Potência | Voltagem | Dimensões | Preço |
|------------|----------|----------|-------------------|-------|
| WALL/3007P | < 60W | 220-240V | 245 x 110 x 150mm | |

Especificações técnicas

Material: Alumínio/Plástico
Tipo drive: Interno



| Referência | Potência | Lumens | Temp. Cor | Voltagem | Dimensões | LED | Preço |
|-------------|----------|--------|-----------|-------------|-------------------|-----|-------|
| WALL/6869-2 | 10W | 700 | 3000K | 85 - 265VAC | 100 x 100 x 135mm | 2 | |

Led Jardim



| | |
|---------------------|------------------------------|
| Lumens | 840lm |
| Material | Die-Cast Aluminium + PC Lens |
| Quantidade de Led's | SMD |
| CRI | >80 |
| Índice de Impacto | IK 08 |
| Índice de Proteção | IP54 |
| Cor | Cinzeno Escuro |
| Certificado | CE, RoHS,ErP |



"L" Cover



"L2" Cover

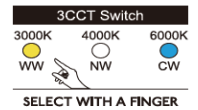

| Referência | Potência | Temp. Cor | Voltagem | Dimensões | Preço |
|--------------|----------|-----------|----------|--------------------|-------|
| WALL/3302-L | 12W | CCT | 220-240V | 240 x 106,5 x 65mm | |
| WALL/3302-L2 | | | | | |

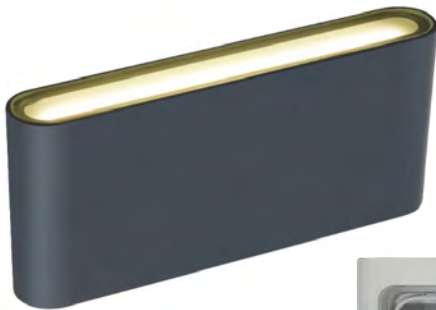

| | |
|---------------------|--------------------|
| Lumens | 680lm |
| Material | Aluminium + Glass |
| Quantidade de Led's | 16 x 2835 SMD Lens |
| CRI | >80 |
| Índice de Impacto | IK 08 |
| Índice de Proteção | IP54 |
| Cor | Cinzeno Escuro |
| Certificado | CE, RoHS,ErP |

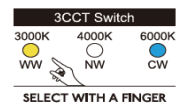
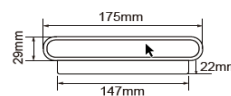

| Referência | Potência | Temp. Cor | Voltagem | Dimensões | Preço |
|------------|----------|-----------|------------|-----------------|-------|
| Wall/1109C | 12W | CCT | 175 ~ 265V | 175 x 90 x 29mm | |



| | |
|---------------------|------------------------------|
| Lumens | 360lm |
| Material | Die-Cast Aluminium + PC Lens |
| Quantidade de Led's | 2 x COB |
| CRI | >80 |
| Índice de Impacto | IK 08 |
| Índice de Proteção | IP54 |
| Cor | Cinzeno Escuro |
| Certificado | CE, RoHS,ErP |

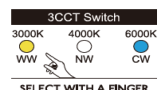
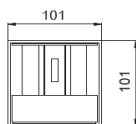

| Referência | Potência | Temp. Cor | Voltagem | Dimensões | Preço |
|------------|----------|-----------|----------|-------------|-------|
| Wall/1102C | 6W | CCT | 175-265V | 101 x 101mm | |
| Wall/1102B | | | | | |

Balizadores Jardim



| | |
|--------------------|-------------------------|
| Lumens | 700lm |
| Material | Die-Cast Aluminium + PC |
| CRI | >80 |
| Índice de Proteção | IP54 |
| Cor | Cinza Escuro |
| Certificado | CE, RoHS, ErP |



| Referência | Potência | Temp. Cor | Voltagem | Dimensões | Preço |
|--------------------------|----------|---|----------|--------------|-------|
| GL-6701RGBW GL-6701WW | 10W | R G B + 3000k 3000K | 220-240V | Ø160 x 300mm | |

Parede Jardim

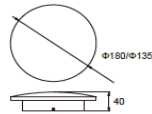

| | |
|--------------------|-------------------------|
| Lumens | 550lm |
| Material | Die-Cast Aluminium + PC |
| CRI | >80 |
| Índice de Proteção | IP54 |
| Cor | Cinza Escuro |
| Certificado | CE, RoHS, ErP |

| Referência | Potência | Temp. Cor | Voltagem | Dimensões | Preço |
|-------------|----------|-----------|----------|--------------|-------|
| WALL/1003-3 | 7W | 3000K | 175-265V | Ø135 x L40mm | |



| | |
|--------------------|----------------------------|
| Lumens | 480lm |
| Material | Die-Cast Aluminium + Glass |
| CRI | >80 |
| Índice de Proteção | IP54 |
| Cor | Cinza Escuro |
| Certificado | CE, RoHS, ErP |

| Referência | Potência | Lumens | Temp. Cor | Voltagem | Dimensões | Preço |
|------------|----------|--------|-----------|----------|-------------------|-------|
| GOMA500 | 6W | 480 | 3000K | 175-240V | 135 x 210 x 500mm | |
| GOMA800 | | | | | 135 x 210 x 800mm | |

Luz Solar com Sensor Inteligente



| | | | |
|--------------|--------------------------------------|------------------------|--------|
| Painel Solar | 5,5V/1,2W / Monocrystalline Silicon | Quantidade de Led´s | 96 pcs |
| Tipo Bateria | 3.7V/2200mAh Li-ion Battery(include) | Índice de Protecção | IP65 |
| Material | ABS + PS Plastic | Tempo de Carga | 8H |
| Certificado | CE, RoHS | Tempo de Funcionamento | 10H |

| Referência | Temp. Cor | Preço |
|------------|-----------|-------|
| GLS-FLAME | 1800K | |



| | |
|---------------------|--------------------------------------|
| Painel Solar | Monocrystalline Silicon |
| Tipo Bateria | 3.2V/1500mAh Li-ion Battery(include) |
| Material | ABS+PC |
| Certificado | CE, RoHS |
| Quantidade de Led´s | 10 pcs |
| Índice de Protecção | IP65 |
| Sensor delay time | 30-35s |
| Sensor distância | 5-7mt |

Obs: Ninguém na área do Sensor (2-6mt): A luz irá acender apenas a 5%
 Alguém na área do Sensor (2-6mt): A luz irá acender a 100%

| Referência | Potência | Temp. Cor | Voltagem | Dimensões | Preço |
|------------|----------|-----------|----------|------------------|-------|
| SL/3W-4 | 2W | 4000K | 5,5V | 100 x 138 x 69mm | |

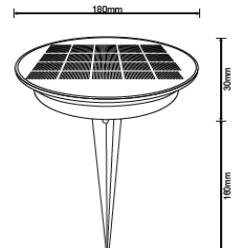

| | |
|------------------------|--------------------------------------|
| Painel Solar | Monocrystalline Silicon |
| Tipo Bateria | 3.2V/3800mAh Li-ion Battery(include) |
| Material | ABS + PS Plastic |
| Certificado | CE, RoHS |
| Quantidade de Led´s | 64 pcs SMD2835 |
| Índice de Protecção | IP68 |
| Tempo de Carga | 8H |
| Tempo de Funcionamento | 8H (Após carregamento completo) |

| Referência | Potência | Temp. Cor | Voltagem | Dimensões | Preço |
|------------|----------|-------------|----------|-------------|-------|
| SL/32001 | 2,6W | 4500K+2000K | 5,5V | 180 x 190mm | |

Luz Solar com Sensor Inteligente



| | |
|------------------------|--------------------------------------|
| Painel Solar | Monocrystalline Silicon |
| Tipo Bateria | 3.7V/2200mAh Li-ion Battery(include) |
| Material | ABS + PS Plastic |
| Certificado | CE, RoHS |
| Quantidade de Led's | 12x2pcs SMD2835 |
| Índice de Proteção | IP65 |
| Tempo de Carga | 6H |
| Tempo de Funcionamento | 6H (Após carregamento completo) |

Acende automaticamente à noite (10-40Lux)

| Referência | Potência | Temp. Cor | Voltagem | Dimensões | Preço |
|------------|----------|-----------|----------|-------------------|-------|
| SL/3001 | 3,6W | 6000K | 6V | 126 x 176 x 720mm | |



| | |
|------------------------|--------------------------------------|
| Painel Solar | Monocrystalline Silicon |
| Tipo Bateria | 3.7V/2200mAh Li-ion Battery(include) |
| Material | ABS + PS Plastic |
| Certificado | CE, RoHS |
| Quantidade de Led's | 138 pcs SMD2835 |
| Índice de Proteção | IP65 |
| Tempo de Carga | 8H |
| Tempo de Funcionamento | 6H (Após carregamento completo) |

| Referência | Potência | Temp. Cor | Voltagem | Dimensões | Preço |
|------------|----------|-----------|----------|------------------|-------|
| SL/3024 | 2W | 6000K | 5,5V | 118 x 85 x 155mm | |

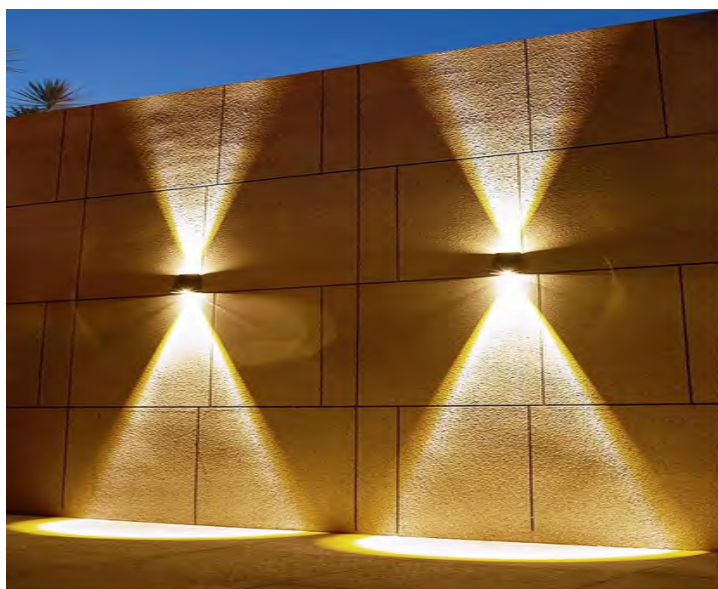

Projektor Solar



| | | | |
|---------------------|------------------------------|---------------------|-------|
| Ângulo Abertura | 90 | CRI | >80 |
| Classe de Protecção | Class III | Índice de Protecção | IP65 |
| Material | Puro Alumínio / Lentes em PC | Índice de Impacto | IK 08 |
| Certificado | TUV, CE, RoHS, ErP, IEC | Fator Potência | >0,9 |

| Referência | Potência | Lumens | Temp. Cor | Solar | Bateria | Dimensão | Led SMD | Preço |
|------------|----------|--------|-----------|--------|-------------|--------------------|---------|-------|
| SL-60W-CCT | 60W | 1200 | CCT | 15W/6V | DC3,2V/10Ah | 210 x 160 x 43,6mm | | |
| SL-100W-6 | 100W | 2000 | 6000K | 20W/6V | DC3,2V/15Ah | 255 x 185 x 43,6mm | 2835 | |
| SL-400W-6 | 400W | 8000 | | 40W/6V | DC3,2V/30Ah | 409 x 301 x 43,6mm | | |

Painel de Rua Solar com Sensor



PHILIPS



Ninguém na área a luz acende a 1/3 da potência.
Quando a aproximação acende a 100%

| | | | |
|-----------------|----------------|---------------------|----------|
| Ângulo Abertura | 120 | CRI | 80 |
| Instalação | 3-4 Mt | Índice de Protecção | IP65 |
| Tempo Carga | 8 Horas | Factor Potência | >0,9 |
| Material | Pure Aluminium | Certificado | CE, RoHS |

| Referência | Potência | Lumens | Temp. Cor | Solar | Bateria | Dimensão | Led SMD | Preço |
|------------|----------|--------|-----------|----------------|--------------|--------------------|----------|-------|
| LRS/15W-6S | 15W | 1500 | | Policristalino | 4,2V, 15,4AH | 450 x 225 x 50mm | 3030-28 | |
| LRS/30W-6S | 30W | 3000 | 6000K | | | 670 x 320 x 50mm | 3030-56 | |
| LRS/50W-6S | 50W | 7500 | | Monocristalino | 12,6V, 14AH | 789 x 367 x 63,5mm | 3030-120 | |

Luz Solar com Sensor Inteligente



| | |
|------------------------|--------------------------------------|
| Painel Solar | Monocrystalline Silicon |
| Tipo Bateria | 3.7V/4000mAh Li-ion Battery(include) |
| Material | Alu + Anti-Glare PC Diffuser |
| Certificado | CE, RoHS |
| Sensor | Microwave Sensor |
| Índice de Proteção | IP54 |
| Tempo de Carga | 6 ~ 8H |
| Tempo de Funcionamento | 12 ~ 15H |

| Referência | Potência | Lumens | Temp. Cor | Voltagem | CRI | Dimensões |
|------------|----------|--------|-----------|----------|-----|-------------------|
| SL-8001-60 | 3W | 200 | 3000K | 5,5V | 80 | 118 x 132 x 600mm |
| SL-8001-80 | | | | | | 118 x 132 x 800mm |



| | |
|------------------------|--------------------------------------|
| Painel Solar | Monocrystalline Silicon |
| Tipo Bateria | 3.7V/4000mAh Li-ion Battery(include) |
| Material | Alu + Anti-Glare PC Diffuser |
| Certificado | CE, RoHS |
| Sensor | Microwave Sensor |
| Índice de Proteção | IP54 |
| Tempo de Carga | 6 ~ 8H |
| Tempo de Funcionamento | 12 ~ 15H |

| Referência | Potência | Lumens | Temp. Cor | Voltagem | CRI | Dimensões | Preço |
|------------|----------|--------|-----------|----------|-----|-------------------|-------|
| SL-8001-W | 3W | 200 | 3000K | 5,5V | 80 | 118 x 135 x 241mm | |

Luz Solar Ambiente



| | |
|------------------------|--|
| Painel Solar | Monocrystalline Silicon |
| Tipo Bateria | 3.7V/4x1200mAh Li-ion Battery(include) |
| Material | ABS + Plastic |
| Certificado | CE, RoHS |
| Sensor | 18 pcs SMD2835 |
| Índice de Proteção | IP65 |
| Tempo de Carga | Solar - 14 ~ 16H / Type C - 8 ~ 9H |
| Tempo de Funcionamento | 25% - 40H // 50% - 15H // 100% - 4H |

| Referência | Potência | Lumens | Temp. Cor | Voltagem | CRI | Dimensões | Preço |
|------------|----------|--------|-----------|----------|-----|------------------|-------|
| SL-2102 | 3W | 330 | 3000K | 5,5V | 80 | 135 x 135 x 82mm | |
| SL-2104 | | | | | | | |

17

Steplights

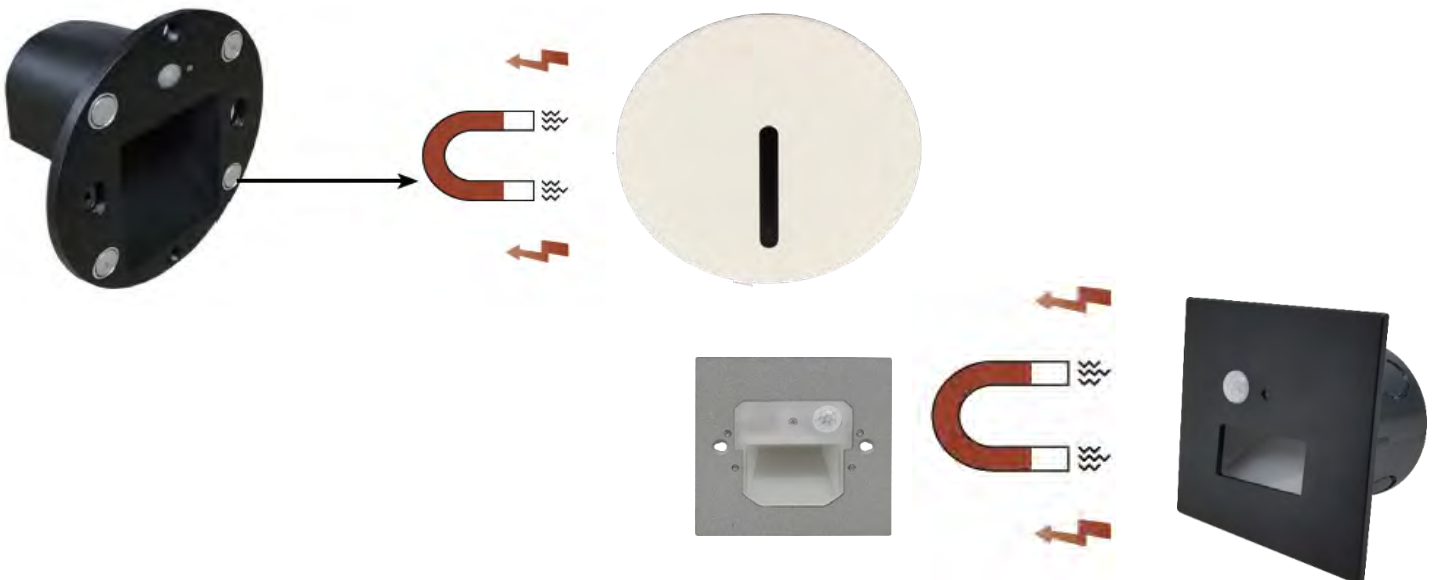

Steps HP

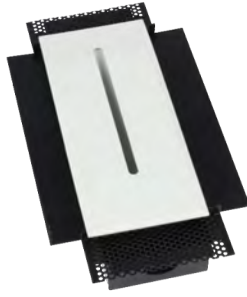
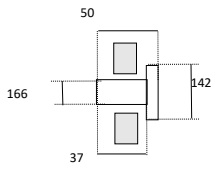
**Especificações técnicas**

Material: Alumínio/Branco
 Cobertura: Transparente
 Tipo de Led: Epistar HP
 Quant. Leds: 1
 Tipo drive: Externo



Obs: Inclui molas de fixação

| Referência | Potência | Lumens | Temp. Cor | Voltagem | Corte | Dimensão | Preço |
|------------|----------|--------|-----------|-------------|------------|------------|-------|
| 646/W | 3W | 200 | 6000K | 85 - 265VAC | 166 x 54mm | 142 x 60mm | |

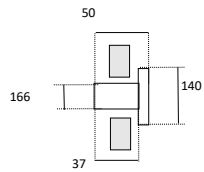
**Especificações técnicas**

Material: Alumínio/Branco
 Cobertura: Transparente
 Tipo de Led: Epistar HP
 Quant. Leds: 1
 Tipo drive: Externo



Obs: Inclui molas de fixação

| Referência | Potência | Lumens | Temp. Cor | Voltagem | Corte | Dimensão | Preço |
|------------|----------|--------|-----------|-------------|------------|------------|-------|
| 647/W | 3W | 200 | 6000K | 85 - 265VAC | 166 x 53mm | 142 x 61mm | |

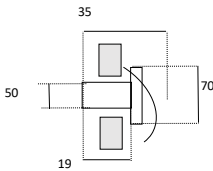
**Especificações técnicas**

Material: Alumínio/Branco
 Cobertura: Não
 Tipo de Led: Epistar HP
 Quant. Leds: 1
 Tipo drive: Externo



Obs: Inclui molas de fixação

| Referência | Potência | Lumens | Temp. Cor | Voltagem | Corte | Dimensão | Preço |
|------------|----------|--------|-----------|-------------|-------|----------|-------|
| 650/W | | 100 | 6000K | 85 - 265VAC | Ø50mm | Ø70mm | |
| 650/WW | 3W | 85 | 3000K | | | | |

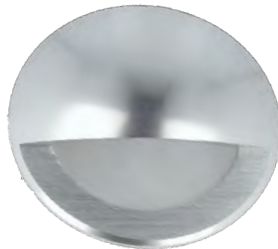
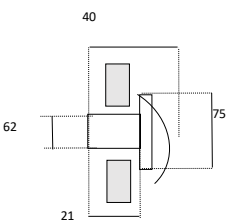
**Especificações técnicas**

Material: Alumínio/Escovado
 Cobertura: Opalina
 Tipo de Led: Epistar HP
 Quant. Leds: 1
 Tipo drive: Externo



| Referência | Potência | Lumens | Temp. Cor | Voltagem | Corte | Dimensão | Preço |
|------------|----------|--------|-----------|-------------|-------|----------|-------|
| 653/W | | 300 | 6000K | 85 - 265VAC | Ø64mm | Ø74mm | |
| 653/WW | 3W | 270 | 3000K | | | | |

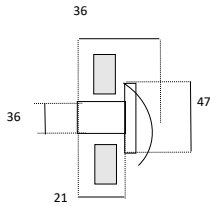

Especificações técnicas
 Material: Alumínio/Escovado
 Cobertura: Opalina
 Tipo de Led: Epistar HP
 Quant. Leds: 1
 Tipo drive: Externo



| Referência | Potência | Lumens | Temp. Cor | Voltagem | Corte | Dimensão | Preço |
|------------|----------|--------|-----------|-------------|-------|----------|-------|
| 654/W | 3W | 300 | 6000K | 85 - 265VAC | Ø36mm | Ø47mm | |
| 654/WW | | 270 | 3000K | | | | |

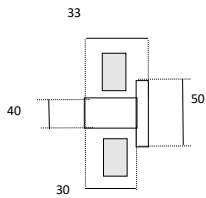

Especificações técnicas
 Material: Alumínio/Lacado Branco
 Cobertura: Opalina
 Tipo de Led: Epistar HP
 Quant. Leds: 1
 Tipo drive: Externo



| Referência | Potência | Lumens | Temp. Cor | Voltagem | Corte | Dimensão | Preço |
|------------|----------|--------|-----------|-------------|-----------|-----------|-------|
| 655/W | 3W | 300 | 6000K | 85 - 265VAC | 65 x 40mm | 80 x 50mm | |
| 655/WW | | 270 | 3000K | | | | |

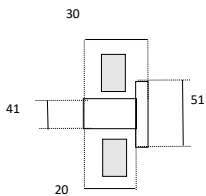

Especificações técnicas
 Material: Alumínio/Escovado
 Cobertura: Não
 Tipo de Led: Epistar HP
 Quant. Leds: 1
 Tipo drive: Externo



| Referência | Potência | Lumens | Temp. Cor | Voltagem | Corte | Dimensão | Preço |
|------------|----------|--------|-----------|-------------|-------|----------|-------|
| 656/W | 1W | 100 | 6000K | 85 - 265VAC | Ø41mm | Ø51mm | |
| 656/WW | | 85 | 3000K | | | | |

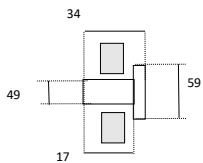

Especificações técnicas
 Material: Alumínio/Escovado
 Cobertura: Não
 Tipo de Led: Epistar HP
 Quant. Leds: 1
 Tipo drive: Externo



Obs: Inclui molas de fixação

| Referência | Potência | Lumens | Temp. Cor | Voltagem | Corte | Dimensão | Preço |
|------------|----------|--------|-----------|-------------|-------|----------|-------|
| 659/W | 3W | 250 | 6000K | 85 - 265VAC | Ø49mm | Ø59mm | |

Steps 3CCT IP66

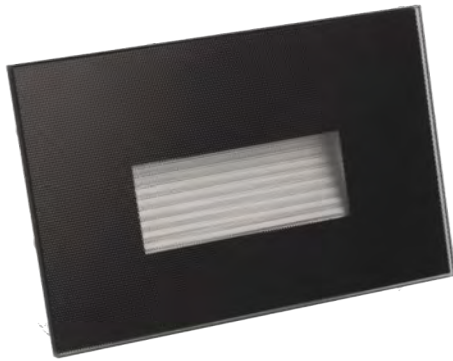
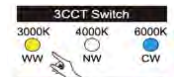

Obs: Ideal p/ aplicar no exterior. Mudança de temperatura de cor no interior.



| Referência | Potência | Lumens | Temp. Cor | Voltagem | Corte | Dimensão | Cor | Preço |
|---------------|----------|--------|-----------|--------------|------------------|-----------------|--------|-------|
| WALL/120P-CCT | | | | | | | Preto | |
| WALL/120B-CCT | 5W | 450 | 3 - CCT | 175 - 265VAC | 87,5 x 53 x 55mm | 105 x 81 x 50mm | Branco | |
| WALL/38P-CCT | | | | | | | Preto | |

Caixa de Encastre

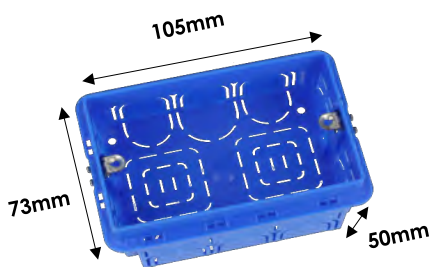

| Referência | Dimensão | Cor | Preço |
|------------|-----------------|------|-------|
| WALL/BOX | 105 x 73 x 50mm | Azul | |

Steps Modulares IP54



Standard EU



Base: WALL/615-3



WALL/R2



WALL/S1

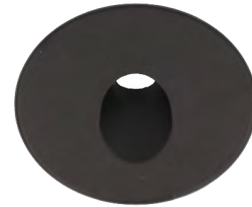

WALL/R1

| | |
|---------------------|-------------------------|
| Material | Die-Cast Aluminium + PC |
| CRI | >80 |
| Índice de Protecção | IP44 |
| Certificado | CE, RoHS,ErP,SELV |

| Referência | Potência | Lumens | Temp. Cor | Voltagem | Corte | Dimensão | Cor | Preço |
|------------|----------|--------|-----------|--------------|-------|----------|--------|-------|
| WALL/615-3 | 3W | 180 | 3000K | 175 - 265VAC | Ø59mm | | Preto | |
| WALL/S1-B | | | | | | Ø85mm | Branco | |
| WALL/R1-B | | | | | | | | |
| WALL/R2-B | | | | | | | | |
| WALL/S1-P | | | | | | | Preto | |
| WALL/S3-P | | | | | | | | |
| WALL/R1-P | | | | | | | | |
| WALL/R2-P | | | | | | | | |

Steps Modulares Com Sensor



Standard EU



Base: WALL/815



WALL/S1S



WALL/S6S



WALL/S3S

| | |
|---------------------|-------------------------|
| Material | Die-Cast Aluminium + PC |
| CRI | >80 |
| Índice de Protecção | IP44 |
| Certificado | CE, RoHS,ErP,SELV |

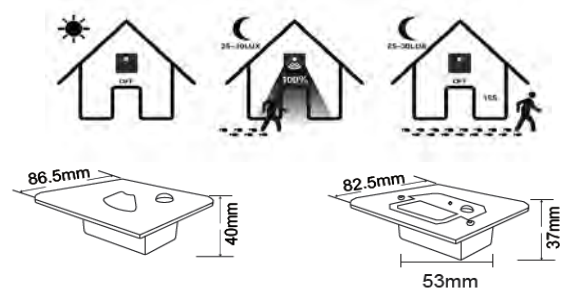

| Referência | Potência | Lumens | Temp. Cor | Voltagem | Corte | Dimensão | Cor | Preço |
|------------|----------|--------|-----------|--------------|-------|-----------|--------|-------|
| WALL/815 | 1,5W | 100 | CCT | 175 - 265VAC | 59mm | | Cinza | |
| WALL/S1S-B | | | | | | 85 x 85mm | Branco | |
| WALL/S3S-B | | | | | | | | |
| WALL/S6S-B | | | | | | | | |
| WALL/S1S-P | | | | | | | Preto | |
| WALL/S3S-P | | | | | | | | |
| WALL/S6S-P | | | | | | | | |

Steps Modulares IP65



| Referência | Potência | Lumens | Temp. Cor | Voltagem | Corte | Dimensão | Cor | Preço |
|---------------|----------|--------|-----------|--------------|-------|----------|--------|-------|
| WALL/C902-B01 | 3W | 200 | 3000K | 100 - 265VAC | Ø60mm | Ø85mm | Branco | |
| WALL/C902-B02 | | | | | | | | |
| WALL/C902-B03 | | | | | | | | |
| WALL/C902-B04 | | | | | | | | |
| WALL/C902-W01 | 3W | 200 | 3000K | 100 - 265VAC | Ø60mm | Ø85mm | Preto | |
| WALL/C902-W02 | | | | | | | | |
| WALL/C902-W03 | | | | | | | | |
| WALL/C902-W04 | | | | | | | | |

18

Painéis de Encastar

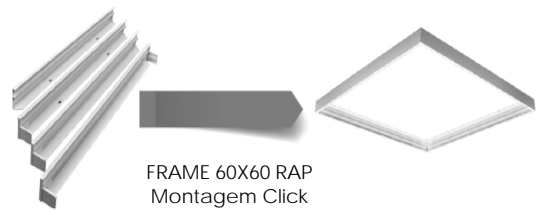

FRAME 60X60 RAP
Montagem Click



Painéis Redondos



Painéis com difusor
LGP e sem pontos
de fuga de Luz

120°



IP

40

FP

0,5

CRI

>80

Obs: As dimensões são meramente indicativas, sujeitas a confirmação.

| Potência | Ref. Branco | Preço | Ref. Nickel | Preço | Temp. Cor | Lumens | Voltagem | Corte | Dimensão | Led SMD |
|----------|-------------|-------|--------------|-------|-----------|--------|--------------|-------------|-------------|---------|
| 5W | 086/5LGP-6 | | 086/5LGPN-6 | | 6000K | 425 | 100 - 265VAC | Ø70mm | Ø83 x 11mm | 2835-25 |
| | 086/5LGP-4 | | 086/5LGPN-4 | | 4000K | 410 | | | | |
| | 086/5LGP-3 | | 086/5LGPN-3 | | 3000K | 400 | | | | |
| 6W | 086/6LGP-6 | | 086/6LGPN-6 | | 6000K | 550 | | Ø105mm | Ø120 x 11mm | 2835-30 |
| | 086/6LGP-4 | | 086/6LGPN-4 | | 4000K | 530 | | | | |
| | 086/6LGP-3 | | 086/6LGPN-3 | | 3000K | 520 | | | | |
| 9W | 086/9LGP-6 | | 086/9LGPN-6 | | 6000K | 765 | | Ø130mm | Ø150 x 11mm | 2835-45 |
| | 086/9LGP-4 | | 086/9LGPN-4 | | 4000K | 750 | | | | |
| | 086/9LGP-3 | | 086/9LGPN-3 | | 3000K | 750 | | | | |
| 12W | 086/12LGP-6 | | 086/12LGPN-6 | | 6000K | 1020 | | Ø155mm | Ø170 x 11mm | 2835-60 |
| | 086/12LGP-4 | | 086/12LGPN-4 | | 4000K | 1005 | | | | |
| | 086/12LGP-3 | | 086/12LGPN-3 | | 3000K | 1000 | | | | |
| 15W | 086/15LGP-6 | | 086/15LGPN-6 | | 6000K | 1275 | Ø170mm | Ø190 x 11mm | 2835-75 | |
| | 086/15LGP-4 | | 086/15LGPN-4 | | 4000K | 1260 | | | | |
| | 086/15LGP-3 | | 086/15LGPN-3 | | 3000K | 1260 | | | | |
| 18W | 086/18LGP-6 | | 086/18LGPN-6 | | 6000K | 1530 | Ø205mm | Ø225 x 11mm | 2835-90 | |
| | 086/18LGP-4 | | 086/18LGPN-4 | | 4000K | 1515 | | | | |
| | 086/18LGP-3 | | 086/18LGPN-3 | | 3000K | 1500 | | | | |
| 20W | 086/20LGP-6 | | 086/20WAE | | 6000K | 1700 | Ø220mm | Ø240 x 11mm | 2835-100 | |
| | 086/20LGP-4 | | 086/20WAE | | 4000K | 1650 | | | | |
| | 086/20LGP-3 | | 086/20WWAE | | 3000K | 1600 | | | | |
| 24W | 086/24LGP-6 | | 086/24LGPN-6 | | 6000K | 2040 | Ø280mm | Ø295 x 11mm | 2835-120 | |
| | 086/24LGP-4 | | 086/24LGPN-4 | | 4000K | 2025 | | | | |
| | 086/24LGP-3 | | 086/24LGPN-3 | | 3000K | 2015 | | | | |

Painéis Quadrados



Painéis com difusor
LGP e sem pontos
de fuga de Luz

120°



IP

40

FP

0,5

CRI

>80

Obs: As dimensões são meramente indicativas, sujeitas a confirmação.

| Potência | Ref. Branco | Preço | Ref. Nickel | Preço | Temp. Cor | Lumens | Voltagem | Corte | Dimensão | Led SMD |
|----------|-------------|-------|--------------|-------|-----------|--------|--------------|-------------|-------------|---------|
| 5W | 083/5LGP-6 | | 083/5LGPN-6 | | 6000K | 425 | 100 - 265VAC | 75 x 75mm | 90 x 90mm | 2835-25 |
| | 083/5LGP-4 | | 083/5LGPN-4 | | 4000K | 410 | | | | |
| | 083/5LGP-3 | | 083/5LGPN-3 | | 3000K | 400 | | | | |
| 6W | 083/6LGP-6 | | 083/6LGPN-6 | | 6000K | 550 | | 105 x 105mm | 120 x 120mm | 2835-30 |
| | 083/6LGP-4 | | 083/6LGPN-4 | | 4000K | 540 | | | | |
| | 083/6LGP-3 | | 083/6LGPN-3 | | 3000K | 530 | | | | |
| 9W | 083/9LGP-6 | | 083/9LGPN-6 | | 6000K | 760 | | 130 x 130mm | 150 x 150mm | 2835-45 |
| | 083/9LGP-4 | | 083/9LGPN-4 | | 4000K | 750 | | | | |
| | 083/9LGP-3 | | 083/9LGPN-3 | | 3000K | 740 | | | | |
| 15W | 083/15LGP-6 | | 083/15LGPN-6 | | 6000K | 1275 | | 170 x 170mm | 195 x 195mm | 2835-75 |
| | 083/15LGP-4 | | 083/15LGPN-4 | | 4000K | 1260 | | | | |
| | 083/15LGP-3 | | 083/15LGPN-3 | | 3000K | 1250 | | | | |
| 18W | 083/18LGP-6 | | 083/18LGPN-6 | | 6000K | 1530 | 205 x 205mm | 225 x 225mm | 2835-100 | |
| | 083/18LGP-4 | | 083/18LGPN-4 | | 4000K | 1515 | | | | |
| | 083/18LGP-3 | | 083/18LGPN-3 | | 3000K | 1505 | | | | |
| 24W | 083/24LGP-6 | | 083/24LGPN-6 | | 6000K | 2040 | 280 x 280mm | 305 x 305mm | 2835-120 | |
| | 083/24LGP-4 | | 083/24LGPN-4 | | 4000K | 2025 | | | | |
| | 083/24LGP-3 | | 083/24LGPN-3 | | 3000K | 2000 | | | | |

Painéis Redondos IP44 6W / 12W / 18W / 24W



Especificações técnicas

Acabamento: Lacado Branco Mate
 Cobertura: Opalina
 Tipo drive: Externo



Obs: As dimensões são meramente indicativas, sujeitas a confirmação.

| Referência | Potência | Lumens | Temp. Cor | Voltagem | Corte | Dimensão | Led SMD | Preço |
|------------|----------|--------|-----------|-------------|--------|----------|---------|-------|
| 086/R6-3 | 6W | 440 | 3000K | 165- 265VAC | Ø75mm | Ø90x9mm | 2835-30 | |
| 086/R12-6 | 12W | 1000 | 6000K | | Ø125mm | Ø145x9mm | 2835-60 | |
| 086/R12-3 | | 950 | 3000K | | | | | |
| 086/R18-6 | 18W | 1650 | 6000K | | Ø155mm | Ø175x9mm | 2835-90 | |
| 086/R18-3 | | 1600 | 3000K | | | | | |

Painel Redondo com Drive Interno IP44



Especificações técnicas

Acabamento: Lacado Branco Mate
 Cobertura: Opalina
 Tipo drive: Interno



Obs: As dimensões são meramente indicativas, sujeitas a confirmação.

| Referência | Potência | Lumens | Temp. Cor | Voltagem | Corte | Dimensão | Led SMD | Preço |
|-------------|----------|--------|-----------|-----------|--------|-------------|---------|-------|
| 086/18PW DI | 18W | 1620 | 4000K | 85-265VAC | Ø155mm | Ø175 x 10mm | 2835-90 | |

Painéis Ajustáveis 6W / 15W / 20W



Especificações técnicas

Acabamento: Lacado Branco Mate
 Cobertura: Opalina
 Tempo de Vida: 30.000H LED
 Tipo drive: Interno



| Referência | Potência | Lumens | Temp. Cor | Voltagem | Corte | Dimensão | Led SMD | Preço |
|---------------|----------|--------|-----------|------------|-----------|-------------|----------|-------|
| 086/9W-4REG | 9W | 720 | 4000K | 100-240VAC | Ø20-100mm | Ø118 x 20mm | 2835-60 | |
| 086/15W-28REG | 15W | 1180 | 2800K | | Ø40-155mm | Ø175 x 20mm | 2835-90 | |
| 086/15W-4REG | | 1200 | 4000K | | | | | |
| 086/20W-28REG | 20W | 1580 | 2800K | | Ø60-200mm | Ø228 x 20mm | 2835-120 | |

Painéis Ajustáveis



| Referência | Potência | Lumens | Temp. Cor | Voltagem | Corte | Dimensão | Led SMD |
|------------|----------|--------|-----------|-----------|-------------|-------------|---------|
| KE-6-4 | 6W | 600 | 4000K | 85-265VAC | Ø75mm | Ø90 x 25mm | 2835 |
| KE-9-4 | 9W | 900 | | | | | |
| KE-12-4 | 12W | 1200 | | | | | |
| KE-18-4 | 18W | 1800 | | | | | |
| KE-24-4 | 24W | 2400 | | | | | |
| KE-36-4 | 36W | 3600 | | | Ø75 - 205mm | Ø225 x 25mm | |

Painel de Led Hi-Performance SideLit - 60 x 60cm / 120 x 30cm



Especificações técnicas

Acabamento: Lacado Branco Mate
 Cobertura: Opalina
 Tempo de Vida: 30.000H LED
 Tipo drive: Externo



Obs: Desig. C/A - com abas para encastrar. As dimensões são indicativas, sujeitas a confirmação.

| | | | |
|--------------------|------------------------------|--------------------|-------|
| Ângulo Abertura | 120° | CRI | 80 |
| Classe de Proteção | Class II | Índice de Proteção | IP44 |
| Material | Alumínio / Difusor PMMA | Índice de Impacto | IK 04 |
| Certificado | TUV SUD, CE, RoHS, SAA, SELV | Fator Potência | >0,9 |

| Referência | Potência | Lumens | Temp. Cor | Voltagem | Corte | Dimensão | Led SMD | Preço |
|------------------|----------|--------|-----------|-------------|------------|--------------|----------|-------|
| 089/40PMMA-4 C/A | 40W | 5000 | 4000K | 85 - 265VAC | 595x595mm | 620 x 620mm | 4014-204 | |
| 089/40PMMA-6 C/A | | | 6000K | | | | | |
| 089/40PMMA-4 | | | 4000K | | | | | |
| 089/40PMMA-6 | | | 6000K | | | | | |
| 090/40PMMA-4 C/A | 40W | 5000 | 4000K | 85 - 265VAC | 1195x295mm | 1220 x 320mm | 4014-240 | |
| 090/40PMMA-6 C/A | | | 6000K | | | | | |
| 090/40PMMA-4 | | | 4000K | | | | | |
| 090/40PMMA-6 | | | 6000K | | | | | |

Painel de Led Hi-Performance BackLit - 60 x 60cm

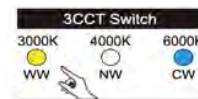

| | | | |
|--------------------|----------------------------|--------------------|-------|
| Ângulo Abertura | 120° | CRI | 80 |
| Classe de Proteção | Class II | Índice de Proteção | IP44 |
| Material | Aluminium / Difusor PS | Índice de Impacto | IK 04 |
| Certificado | CE/RoHS/EMC/SAA/SASO/ISO90 | Fator Potência | >0,9 |

| Referência | Potência | Lumens | Temp. Cor | Voltagem | Dimensão | Led SMD | Preço |
|--------------|----------|--------|-----------|--------------|-------------|---------|-------|
| 089/40BL-CCT | 40W | 5000 | 3CCT | 100 - 250VAC | 595 x 595mm | SMD4014 | |

Painel de Led Quadrado 30 x 30cm



As dimensões são indicativas, sujeitas a confirmação.

Especificações técnicas

Acabamento: Lacado Branco Mate
 Cobertura: Opalina
 Tipo drive: Externo



| Referência | Potência | Lumens | Temp. Cor | Voltagem | Dimensão | Preço |
|----------------|----------|--------|-----------|--------------|-------------|-------|
| 089/24-30x30-W | 24W | 2200 | 6000K | 200 - 250VAC | 295 x 295mm | |

Painel de Led Retangular Encastrar 60 x 30cm



Especificações técnicas

Acabamento: Lacado Branco Mate
 Cobertura: Opalina
 Tipo drive: Externo



Obs: Painel com abas para encastrar. As dimensões são indicativas, sujeitas a confirmação.

| Referência | Potência | Lumens | Temp. Cor | Voltagem | Corte | Dimensão | Led SMD | Preço |
|----------------------------------|----------|--------|-----------|--------------|-----------|------------------------|----------|-------|
| 090/24PMMA-4 090/24PMMA-4 C/A | 24W | 2400 | 4000K | 200 - 250VAC | 295x595mm | 295x595mm 320x620mm | 2835-120 | |

Aro para painel 60 x 60cm / 120 x 30cm (frame)

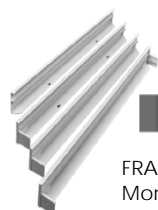

FRAME 60X60 RAP
Montagem Click



FRAME 60X60

Obs: Ideal para aplicação exterior de painel. As dimensões são indicativas, sujeitas a confirmação.

| Referência | Cor | Material | Voltagem | Dimensão |
|------------------|--------|----------|------------|---------------|
| FRAME 60X30 RAP | Branco | Aluminio | 595X295mm | 630x330x50mm |
| FRAME 60X60 RAP | | | | 630x630x50mm |
| FRAME 120X30 RAP | Cinza | Aluminio | 1195X295mm | 1230x330x50mm |
| FRAME 120X30AL | | | | |

19

Painéis de Superfície

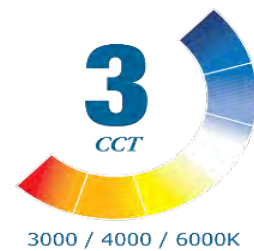

Painéis de Superfície Redondos



Especificações técnicas

Acabamento: Lacado Branco Mate
 Cobertura: Opalina
 Tipo drive: Externo

120°

IP 40

FP
0,55CRI
>80

| Referência | Potência | Lumens | Temp. Cor | Voltagem | Base | Dimensão | SMD | Preço |
|-------------|----------|--------|-----------|--------------|---------|-----------|----------|-------|
| 661/12LGP-6 | 12W | 1080 | 6000K | 200 - 250VAC | Redondo | Ø175x38mm | 2835-60 | |
| 661/12LGP-4 | | 1070 | 4000K | | | | | |
| 661/12S83 | | 1060 | 3000K | | | | | |
| 662/18LGP-6 | 18W | 1600 | 6000K | 200 - 250VAC | Redondo | Ø225x38mm | 2835-90 | |
| 662/18LGP-4 | | 1550 | 4000K | | | | | |
| 662/18S83 | | 1500 | 3000K | | | | | |
| 663/24LGP-6 | 24W | 1800 | 6000K | 200 - 250VAC | Redondo | Ø300x38mm | 2835-120 | |
| 663/24LGP-4 | | 1750 | 4000K | | | | | |
| 663/24S83 | | 1700 | 3000K | | | | | |



Especificações técnicas

Acabamento: Lacado Branco Mate
 Cobertura: Opalina
 Tipo drive: Externo

120°

IP 44

FP
0,55CRI
>80

| Referência | Potência | Lumens | Temp. Cor | Voltagem | Base | Dimensão | SMD | Preço |
|------------|----------|--------|-----------|-------------|---------|-----------|----------|-------|
| 086/RS12-6 | 12W | 1000 | 6000K | 165- 265VAC | Redondo | Ø145x35mm | 2835-60 | |
| 086/RS12-3 | | 950 | 3000K | | | | | |
| 086/RS18-3 | 18W | 1600 | 3000K | | | | | |
| 086/RS24-3 | 24W | 2050 | 3000K | | | Ø230x35mm | 2835-120 | |

Painéis de Superfície Quadrados



Especificações técnicas

Acabamento: Lacado Branco Mate
 Cobertura: Opalina
 Tipo drive: Externo

120°

IP 40

FP
0,55CRI
>80

| Referência | Potência | Lumens | Temp. Cor | Voltagem | Base | Dimensão | SMD | Preço |
|---------------|----------|--------|-----------|--------------|----------|--------------|----------|-------|
| 666/6SQ86 | 6W | 450 | 6000K | 200 - 250VAC | Quadrado | 120x120x38mm | 2835-30 | |
| 666/6SQ84 | | 440 | 4000K | | | | | |
| 666/6SQ83 | | 430 | 3000K | | | | | |
| 664/12S86 | 12W | 1080 | 6000K | 200 - 250VAC | Quadrado | 175x175x38mm | 2835-60 | |
| 664/12SQLGP-4 | | 1070 | 4000K | | | | | |
| 664/12S83 | | 1060 | 3000K | | | | | |
| 665/18SQLGP-6 | 18W | 1600 | 6000K | 200 - 250VAC | Quadrado | 225x225x38mm | 2835-90 | |
| 665/18SQLGP-4 | | 1550 | 4000K | | | | | |
| 665/18SQ83 | | 1500 | 3000K | | | | | |
| 667/24SQLGP-6 | 24W | 1800 | 6000K | 200 - 250VAC | Quadrado | 300x300x38mm | 2835-120 | |
| 667/24SQLGP-4 | | 1750 | 4000K | | | | | |
| 667/24SQ83 | | 1700 | 3000K | | | | | |

Painéis de Superfície Redondo/Quadrado

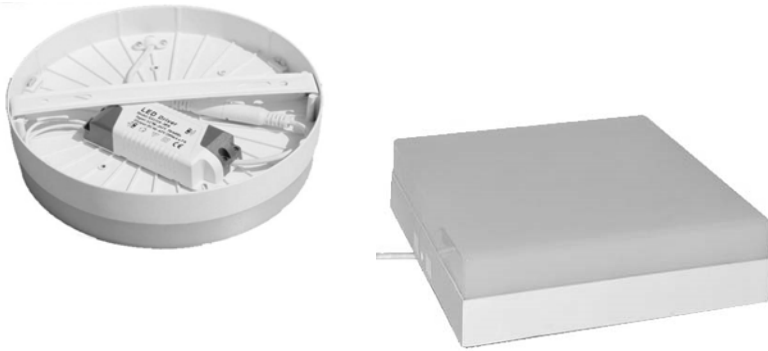

Especificações técnicas

Acabamento: Lacado Branco Mate
 Cobertura: Opalina
 Tipo drive: Externo
 Tempo de Vid: 30.000H LED

120°



IP 40

FP
0,80CRI
>80

| Referência | Potência | Lumens | Temp. Cor | Voltagem | Base | Dimensão | SMD | Preço |
|------------|----------|--------|-----------|--------------|----------|------------------|---------|-------|
| 662/18PWRS | 18W | 1680 | 4000K | 165 - 265VAC | Redondo | 180 x 55mm | 2835-90 | |
| 665/18PWSQ | | | | | Quadrado | 180 x 180 x 55mm | | |

Painel de Superfície Redondo

DELICATED APPEARANCE
 Material: ABS plastic housing,
 3.0 nanometer light guide plate



INTERGRATED BODY
 Intergrated body,
 small volumn, light weight.

FUNCTION SELECTION
 Single color / DIP 3CCT control
 / 3CCT wall switch control



120°



IP 42

FP

CRI

| Referência | Potência | Lumens | Temp. Cor | Voltagem | Base | Dimensão | SMD |
|------------|------------------|--------|-----------|-------------|---------|------------|----------|
| 089/50-CCT | 50W | 5000 | 3CCT | 185- 265VAC | Redondo | 600 x 27mm | 2835-240 |
| 089/KIT50 | Kit de suspensão | | | | | 400 x 25mm | 2835-180 |
| 089/32-CCT | 32W | 3200 | | | | 230 x 27mm | 2835-120 |
| 089/KIT32 | Kit de suspensão | | | | | | |
| 089/18-CCT | 18W | 1800 | | | | | |

20

Painéis com Sensor

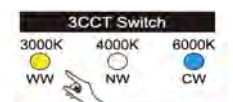

Painéis CCT + Sensor Micro-Wave



Especificações técnicas

Acabamento: Lacado Branco Mate
 Tempo de vida: 30.000H Led
 Cobertura: Opalina
 Tipo de Led: Alto Brilho
 Tempo de Estabilização: 35 segundos

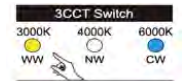

| Referência | Potência | Lumens | Temp. Cor | Voltagem | Corte | Dimensão | Led SMD | Preço |
|--------------|----------|--------|-----------|-----------|-------------|-------------|---------|-------|
| 086/18CCT3-S | 18W | 1530 | CCT | 85-265VAC | Ø65 - 180mm | Ø225 x 20mm | 2835-90 | |

Painéis com Sensor IR



Especificações técnicas

Acabamento: Lacado Branco Mate
 Tempo de vida: 30.000H Led
 Cobertura: Opalina
 Tipo de Led: Alto Brilho
 Tempo de Estabilização: 35 segundos



| Referência | Potência | Lumens | Temp. Cor | Voltagem | Corte | Dimensão | Led SMD | Preço |
|-------------|----------|--------|-----------|----------|-------------|------------|---------|-------|
| 086/18PWRSN | 18W | 1680 | 4000K | 85-265V | Ø55 - 200mm | 225 x 30mm | 2835-90 | |



21

Hay Bays



Hay Bays



PHILIPS
MW
MEAN WELL



| | | | |
|--------------------|-------------------------------------|--------------------|-------|
| Ângulo Abertura | 90 | CRI | 80 |
| Classe de Proteção | Class I | Índice de Proteção | IP65 |
| Material | Pure Aluminium | Índice de Impacto | IK 08 |
| Certificado | Dekra, TUV, CE, RoHS, ErP, SGS, SAA | Fator Potência | >0,9 |

| Referência | Potência | Lumens | Temp. Cor | Voltagem | Fixação | Dimensão | Led SMD | Preço |
|--------------|----------|--------|-----------|-------------|----------------|--------------|----------|-------|
| HAY/BAY 100N | 100 W | 13 000 | | | | Ø368 x 187mm | 3030-133 | |
| HAY/BAY 150N | 150 W | 19 500 | 5000K | 90 - 305VAC | Aste/Suspensão | Ø368 x 187mm | 3030-210 | |
| HAY/BAY 200N | 200 W | 26 000 | | | | Ø423 x 187mm | 3030-315 | |



PHILIPS
SOSEN
LED DRIVER

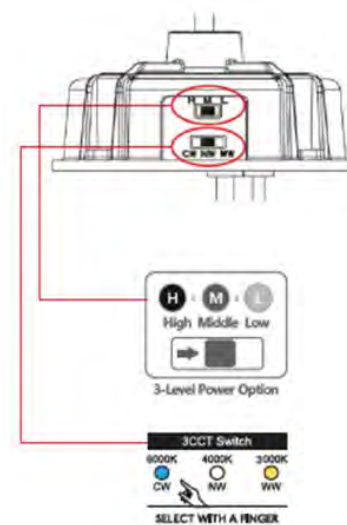

| | | | |
|--------------------|------------------------------|--------------------|-------|
| Ângulo Abertura | 90 | CRI | 80 |
| Classe de Proteção | Class I | Índice de Proteção | IP65 |
| Material | Pure Aluminium | Índice de Impacto | IK 09 |
| Certificado | TUV, CE, RoHS, ErP, SGS, SAA | Fator Potência | >0,9 |

| Referência | Potência | Lumens | Temp. Cor | Voltagem | Fixação | Dimensão | Led SMD | Preço |
|---------------------|----------------|--------|-----------|--------------|----------------|--------------|---------|-------|
| HAY/BAY 200W PA+CCT | 120w-160w-200w | 17 000 | CCT | 175 - 277VAC | Aste/Suspensão | Ø273 x 117mm | 2835 | |

Hay Bays



PHILIPS
SOSEN
 LED DRIVER



| | | | |
|--------------------|------------------------------|--------------------|-------|
| Ângulo Abertura | 90 | CRI | 80 |
| Classe de Proteção | Class I | Índice de Proteção | IP65 |
| Material | Pure Aluminium | Índice de Impacto | IK 09 |
| Certificado | TUV, CE, RoHS, ErP, SGS, SAA | Fator Potência | >0,9 |

| Referência | Potência | Lumens | Temp. Cor | Voltagem | Fixação | Dimensão | Led SMD | Preço |
|--------------|---------------|--------|-----------|--------------|----------------|--------------|----------|-------|
| HAY/BAY 100P | 100 W | 15 000 | | | | Ø260 x 160mm | 2835-140 | |
| HAY/BAY 150P | 80-120-150 W | 22 500 | CCT | 180 - 305VAC | Aste/Suspensão | Ø310 x 160mm | 2835-210 | |
| HAY/BAY 200P | 100-150-200 W | 30 000 | | | | Ø350 x 180mm | 2835-280 | |



PHILIPS
SOSEN
 LED DRIVER

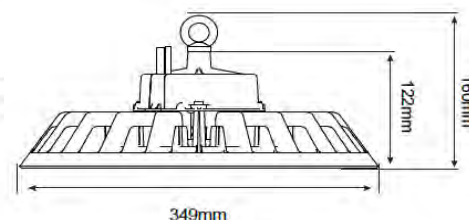
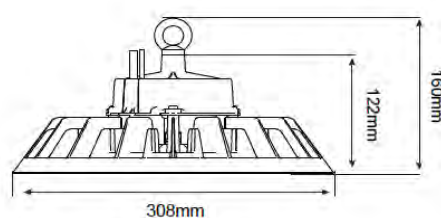
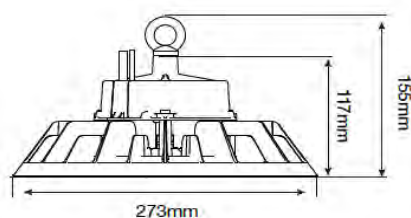

| | | | |
|--------------------|------------------------------|--------------------|-------|
| Ângulo Abertura | 120 | CRI | 80 |
| Classe de Proteção | Class I | Índice de Proteção | IP65 |
| Material | Pure Aluminium | Índice de Impacto | IK 09 |
| Certificado | TUV, CE, RoHS, ErP, SGS, SAA | Fator Potência | >0,9 |

| Referência | Potência | Lumens | Temp. Cor | Voltagem | Fixação | Dimensão | Led SMD | Preço |
|--------------|----------|--------|-----------|--------------|----------------|--------------|----------|-------|
| HAY/BAY 100K | 100 W | 17 000 | | | | Ø273 x 117mm | 2835-140 | |
| HAY/BAY 150K | 150 W | 22 500 | 5700K | 120 - 277VAC | Aste/Suspensão | Ø308 x 122mm | 2835-210 | |
| HAY/BAY 200K | 200 W | 30 000 | | | | Ø349 x 122mm | 2835-280 | |

Suportes para Hay Bays



| Referência | Descrição | Preço |
|-------------------|--------------------------------------|-------|
| SUP/HBAY 150/200W | Suporte para Hay Bays de 150W e 200W | |
| SUP/HBAY 100W | Suporte para Hay Bays de 100W | |

Lineares

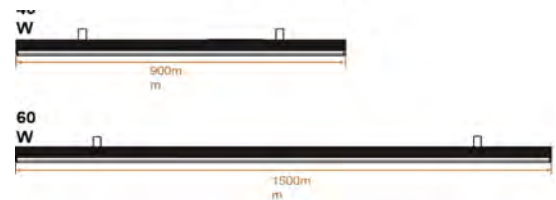

| | | | |
|--------------------|-------------------------|--------------------|-------|
| Ângulo Abertura | 110 | CRI | 80 |
| Classe de Proteção | Class II | Índice de Proteção | IP40 |
| Material | Pure Aluminium | Índice de Impacto | IK 09 |
| Certificado | TUV, CE, RoHS, ErP, SAA | Fator Potência | >0,9 |

| Referência | Potência | Lumens | Temp. Cor | Voltagem | Fixação | Dimensão | Led SMD | Preço |
|------------|----------|--------|-----------|--------------|----------------|------------------|----------|-------|
| LN/HB40 | 40 W | 5 600 | CCT | 120 - 277VAC | Aste/Suspensão | 900 x 75 x 80mm | 2835-140 | |
| LN/HB60 | 60 W | 8 400 | | | | 1500 x 75 x 80mm | 2835-210 | |



22

Fitas LED 12V



4,8W/Mt.

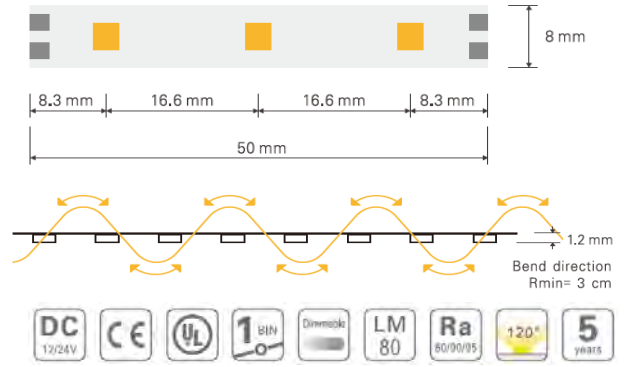

Obs.: A nossa fita de 12V/24V é vendida em rolos de 5 metros

| Referência | Potência | Led SMD | Lumens/Mt. | Temp. Cor | Voltagem | IP | CRI | Preço/mt |
|------------|----------|---------|------------|-----------|----------|----|-----|----------|
| 256/C | 4,8W/mt | 3528-60 | 550 | 6000K | 12VDC | 20 | | |
| 255/860 | | | 720 | | | | | |
| 255/840 | | 2835-60 | 700 | 4000K | | | | |
| 255/827 | | | 690 | 2800K | | | | |
| 267/RS | | 3528-60 | 500 | 3000K | | | | |
| 266/RS | | | 610 | 6000K | | | | |
| 256/860 | | | 720 | 6000K | | | | |
| 256/840 | | | 672 | 4000K | | | | |
| 256/827 | | | | 2800K | | | | |
| 287/S | | 3528-60 | | Azul | | | | |

5,7W/Mt.

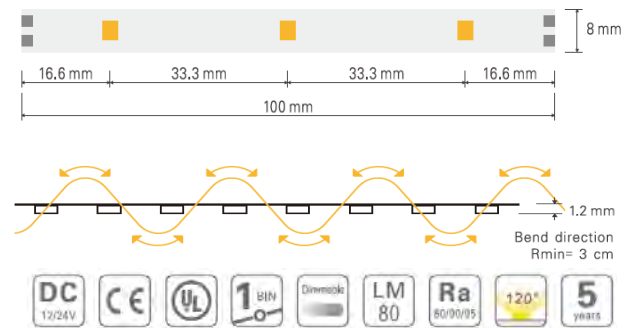

Obs.: A nossa fita de 12V/24V é vendida em rolos de 5 metros

| Referência | Potência | Led SMD | Lumens/Mt. | Temp. Cor | Voltagem | IP | CRI | Preço/mt |
|------------|----------|---------|------------|-----------|----------|----|-----|----------|
| 239/12-6 | 5,7W/mt | 2835-30 | 599 | 6000K | 12VDC | 20 | 80 | |
| 239/12-28 | | | 522 | 2800K | | | | |



7,2W/Mt.

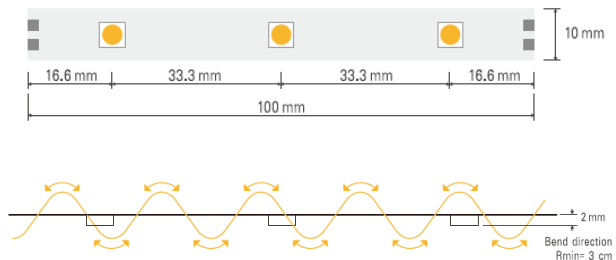

Obs.: A nossa fita de 12V/24V é vendida em rolos de 5 metros

| Referência | Potência | Led SMD | Lumens/Mt. | Temp. Cor | Voltagem | IP | CRI | Preço/mt |
|------------|----------|---------|------------|-----------|----------|----|-----|----------|
| 270/RS | 7,2W/mt | 5050-30 | 600 | 6000K | 12VDC | 65 | 80 | |
| 270/S | | | | 6000K | | | | |
| 298 | | | | 6000K | | | | |
| 298/WW | | | | 3000K | | | | |

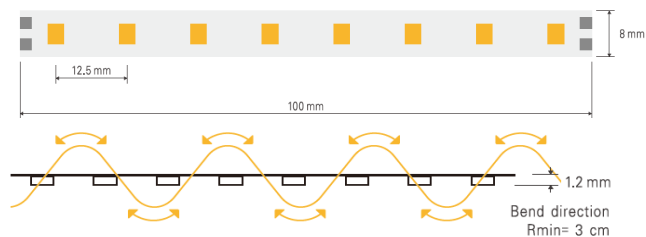

Obs.: A nossa fita de 12V/24V é vendida em rolos de 5 metros

| Referência | Potência | Led SMD | Lumens/Mt. | Temp. Cor | Voltagem | IP | CRI | Preço/mt |
|------------|----------|---------|------------|-----------|----------|----|-----|----------|
| 240/860 | 7,2W/mt | 2835-80 | 1 152 | 6000K | 12VDC | 20 | 80 | |
| 240/840 | | | 1 100 | 4000K | | | | |
| 240/830 | | | 1 080 | 3000K | | | | |
| 240/828 | | | 1 080 | 2800K | | | | |
| 241/W | | | 1 152 | 6000K | | | | |
| 241/840 | | | 1 100 | 4000K | | | | |
| 241/828 | 1 080 | 2800K | | | | | | |

3D 12W/Mt.



Esta fita é vendida em rolos de 2.5 metros

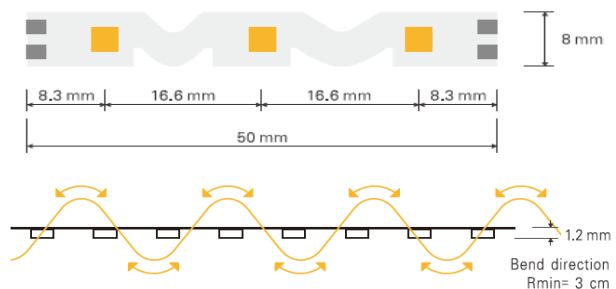

Obs.: Fita ideal p/ ângulos retos devido ao seu formato permite fazer curvas e ângulos de 90°, assim como contornar uma circunferência.

| Referência | Potência | Led SMD | Lumens/Mt. | Temp. Cor | Voltagem | IP | CRI | Preço/mt |
|------------|----------|---------|------------|-----------|----------|----|-----|----------|
| 244/3DPW | 12W/mt | 2835-60 | 1 250 | 4000K | 12VDC | 20 | 80 | |

12W/Mt.

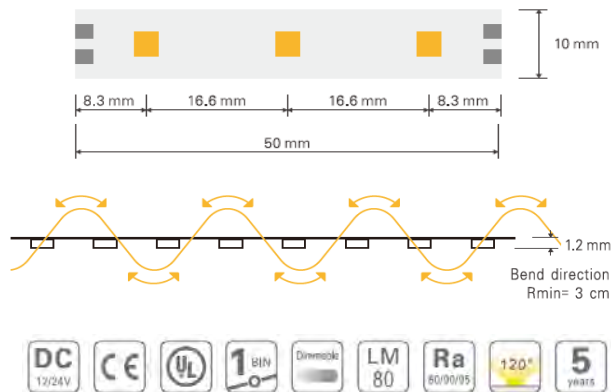

Obs.: A nossa fita de 12V/24V é vendida em rolos de 5 metros

| Referência | Potência | Led SMD | Lumens/Mt. | Temp. Cor | Voltagem | IP | CRI | Preço/mt | |
|------------|----------|---------|------------|-----------|----------|----|-----|----------|----|
| 244/W | 12W/mt | 2835-60 | 1 350 | 6000K | 12VDC | | 80 | | |
| 244/840 | | | 1 250 | 4000K | | | | | |
| 244/WW | | | 1 150 | 3000K | | | | | 20 |
| 244/824 | | | 1 150 | 2400K | | | | | |
| 244/822 | | | 1 150 | 2200K | | | | | |
| 245/W | 12W/mt | 2835-60 | 1 350 | 6000K | 12VDC | 65 | 80 | | |
| 245/840 | | | 1 250 | 4000K | | | | | |
| 245/WW | | | 1 150 | 3000K | | | | | |
| 245/824 | | | 1 150 | 2400K | | | | | |
| 245/822 | | | 1 150 | 2200K | | | | | |

13W/Mt.

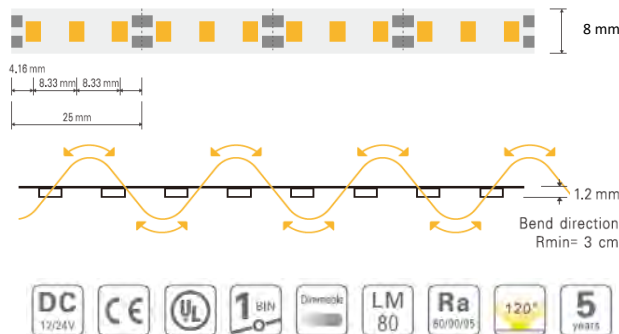

Obs.: A nossa fita de 12V/24V é vendida em rolos de 5 metros

| Referência | Potência | Led SMD | Lumens/Mt. | Temp. Cor | Voltagem | IP | CRI | Preço/mt | |
|------------|----------|----------|------------|-----------|----------|----|-----|----------|----|
| 246/860 | 13W/mt | 2835-120 | 1 550 | 6000K | 12VDC | | 80 | | |
| 246/840 | | | 1 450 | 4000K | | | | | 20 |
| 246/830 | | | 1 350 | 3000K | | | | | |
| 247/860 | 13W/mt | 2835-120 | 1 550 | 6000K | 12VDC | 65 | 80 | | |
| 247/840 | | | 1 450 | 4000K | | | | | |
| 247/830 | | | 1 350 | 3000K | | | | | |



14,4W/Mt.

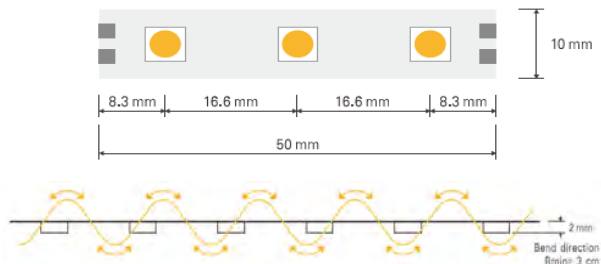

Obs.: A nossa fita de 12V/24V é vendida em rolos de 5 metros

| Referência | Potência | Led SMD | Lumens/Mt. | Temp. Cor | Voltagem | IP | CRI | Preço/mt |
|------------|----------|---------|------------|-----------|----------|----|-----|----------|
| 273/S4 | | | 1 150 | 4000K | | | | |
| 262/R | | | 900 | Vermelho | | | | |
| 262/G | | | 900 | Verde | | | | |
| 262/B | 14,4W/mt | 5050-60 | 900 | Azul | 12VDC | 65 | 80 | |
| 262/Y | | | 900 | Amarelo | | | | |
| 296 | | | 1 150 | 6000K | | 68 | | |
| 296/WW | | | 1 150 | 3000K | | | | |

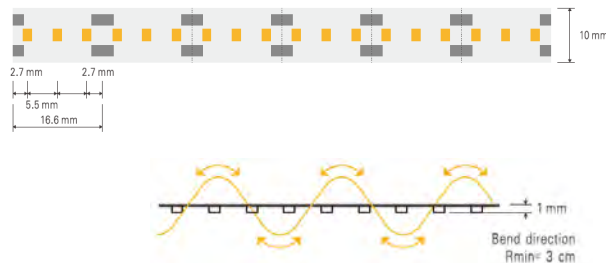

Obs.: A nossa fita de 12V/24V é vendida em rolos de 5 metros

| Referência | Potência | Led SMD | Lumens/Mt. | Temp. Cor | Voltagem | IP | CRI | Preço/mt |
|------------|----------|----------|------------|-----------|----------|----|-----|----------|
| 232/PW | 14,4W/mt | 2216-180 | 1 300 | 4000K | 12VDC | 20 | 90 | |

18W/Mt.

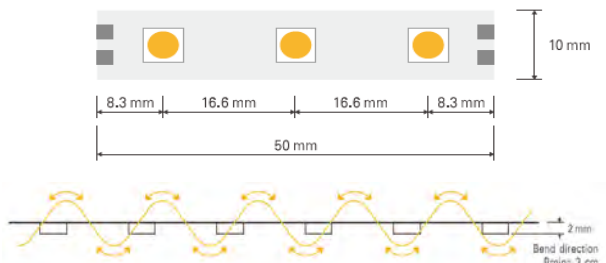

Obs.: A nossa fita de 12V/24V é vendida em rolos de 5 metros

| Referência | Potência | Led SMD | Lumens/Mt. | Temp. Cor | Voltagem | IP | CRI | Preço/mt |
|------------|----------|---------|------------|-----------|----------|----|-----|----------|
| 243/840 | 18W/mt | 5630-60 | 1 800 | 4000K | 12VDC | 65 | 80 | |
| 243/WW | | | 1 700 | 3000K | | | | |

19,2W/Mt.

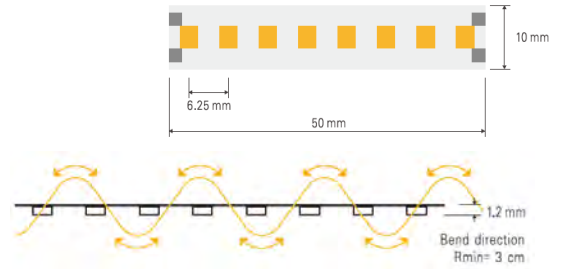

Obs.: A nossa fita de 12V/24V é vendida em rolos de 5 metros

| Referência | Potência | Led SMD | Lumens/Mt. | Temp. Cor | Voltagem | IP | CRI | Preço/mt |
|------------|----------|----------|------------|-----------|----------|----|-----|----------|
| 242N/860 | 19,2W/mt | 2835-160 | 2 496 | 6000K | 12VDC | 20 | 80 | |
| 242N/840 | | | 2 400 | 4000K | | | | |
| 242N/830 | | | 2 326 | 3000K | | | | |
| 243N/860 | | | 2 496 | 6000K | | | | |
| 243N/840 | | | 2 400 | 4000K | | | | |
| 243N/830 | | | 2 326 | 3000K | | | | |

22W/Mt.

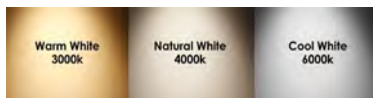
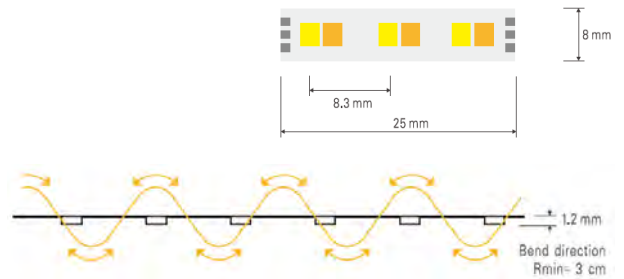

Obs.: A nossa fita de 12V/24V é vendida em rolos de 5 metros

| Referência | Potência | Led SMD | Lumens/Mt. | Temp. Cor | Voltagem | IP | CRI | Preço/mt |
|------------|----------|----------|------------|-----------|----------|----|-----|----------|
| 232/CCT | 22W/mt | 2216-240 | 2 100 | CCT | 12VDC | 20 | 80 | |



RGB 7,2W/Mt.

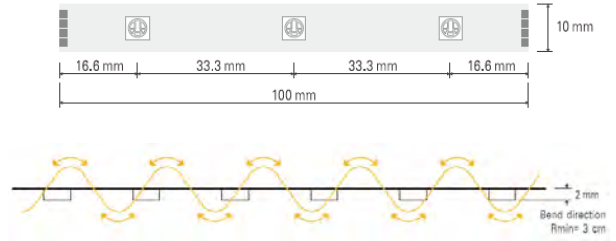
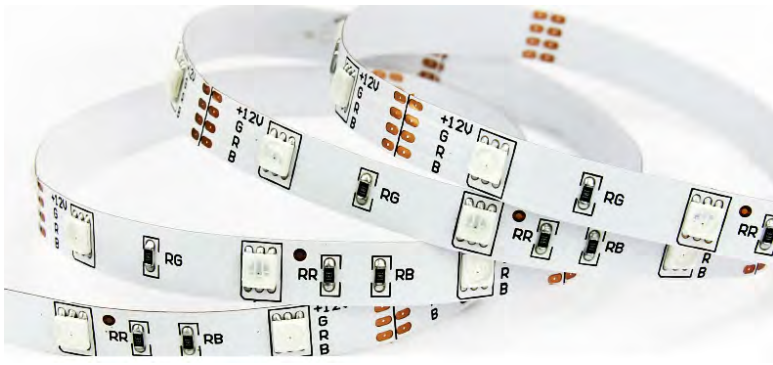

Obs.: A nossa fita de 12V/24V é vendida em rolos de 5 metros

| Referência | Potência | Led SMD | Lumens/Mt. | Temp. Cor | Voltagem | IP | CRI | Preço/mt |
|------------|----------|---------|--------------|--------------|----------|----|-----|----------|
| 297 | 7.2W/Mt. | 5050-30 | 500 (3cores) | R G B | 12VDC | 68 | 80 | |

RGB COB 14W/Mt.

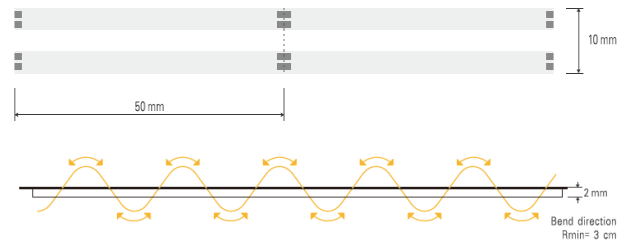

Obs.: A nossa fita de 12V/24V é vendida em rolos de 5 metros

| Referência | Potência | Led SMD | Lumens/Mt. | Temp. Cor | Voltagem | IP | CRI | Preço/mt |
|-------------|----------|-------------|------------|--------------|----------|----|-----|----------|
| 512/COB-RGB | 14W/ Mt | 756 Led/Mt. | | R G B | 12VDC | 20 | 90 | |

RGB 14,4W/Mt.

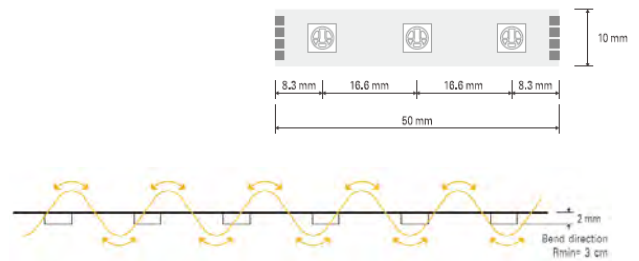
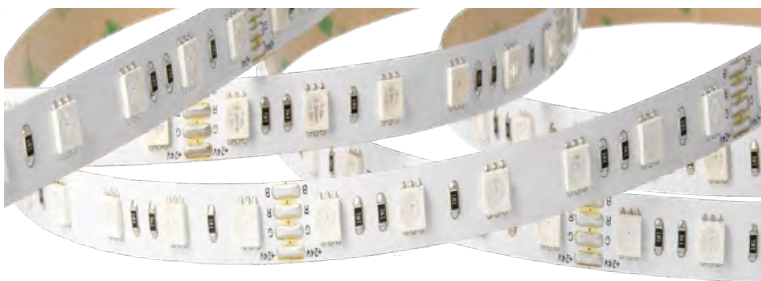

Obs.: A nossa fita de 12V/24V é vendida em rolos de 5 metros

| Referência | Potência | Led SMD | Lumens/Mt. | Temp. Cor | Voltagem | IP | CRI | Preço/mt |
|------------|------------|---------|--------------|--------------|----------|----|-----|----------|
| 299/SN | 14,4W/ Mt. | 5050-60 | 1000(3cores) | R G B | 12VDC | 20 | 80 | |

RGB+W / RGB+CCT 18W

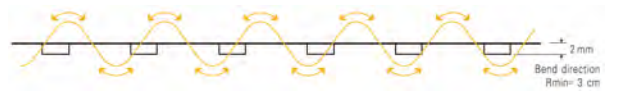
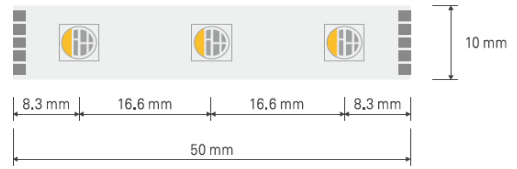
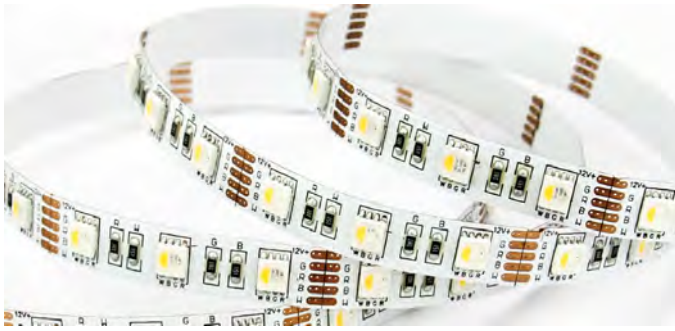

Single-Chip



Obs.: A nossa fita de 12V/24V é vendida em rolos de 5 metros

| Referência | Potência | Led SMD | Lumens/Mt. | Temp. Cor | Voltagem | IP | CRI | Preço/mt |
|------------|------------|---------|--------------|---------------|----------|----|-----|----------|
| 313 | 18W/mt | | 1250 (6000K) | R G B + 6000K | | | | |
| 314 | | 5050-60 | 1050 (3000K) | R G B + 3000K | 12VDC | 20 | 80 | |
| 314/S-12 | 19,2W/ Mt. | | 1300 (3000K) | R G B + 3000K | | 65 | | |



23

Fitas LED 24V

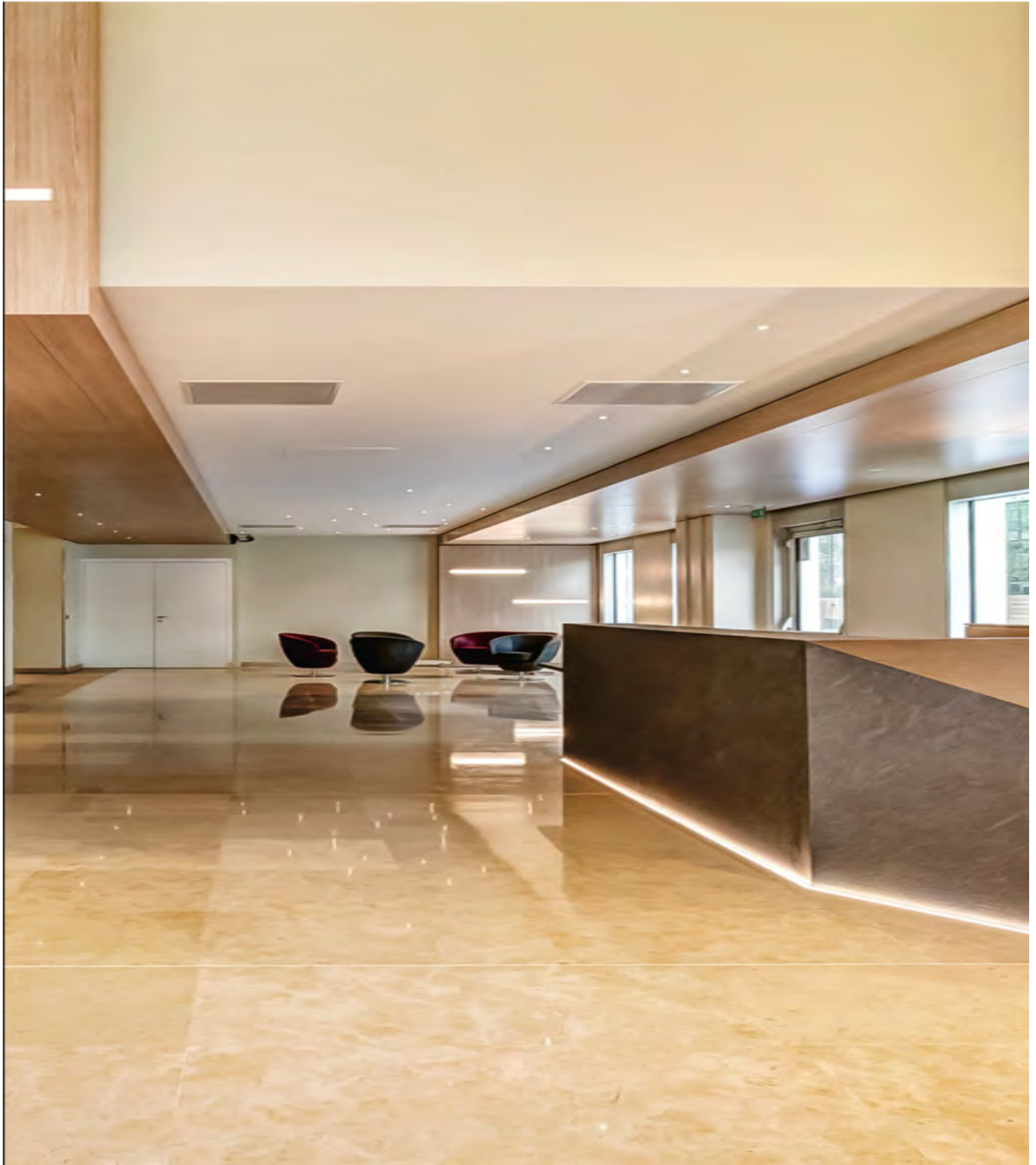

4,8W/Mt.

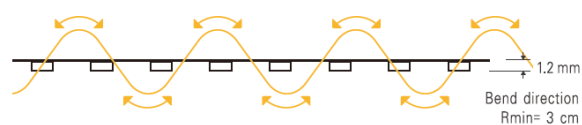
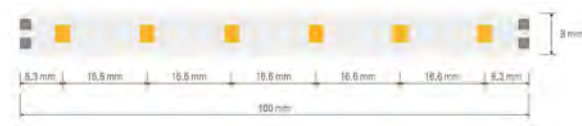
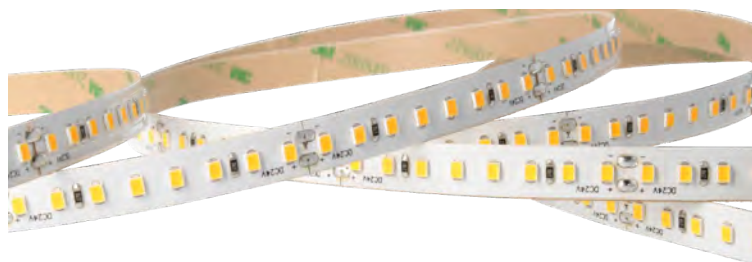

Obs.: A nossa fita de 12V/24V é vendida em rolos de 5 metros

| Referência | Potência | Led SMD | Lumens/Mt. | Temp. Cor | Voltagem | IP | CRI | Preço/mt |
|------------|----------|---------|------------|-----------|----------|----|-----|----------|
| 255/860-24 | | | 720 | 6000K | | | | |
| 255/840-24 | | | 696 | 4000K | | 20 | | |
| 255/827-24 | | | 672 | 2700K | | | | |
| 255/824-24 | | | 660 | 2400K | | | | |
| 256/860-24 | 4,8W | 2835-60 | 720 | 6000K | 24VDC | | 80 | |
| 256/840-24 | | | 696 | 4000K | | 65 | | |
| 256/827-24 | | | 672 | 2700K | | | | |
| 256/822-24 | | | 660 | 2400K | | | | |

7,2W/Mt.

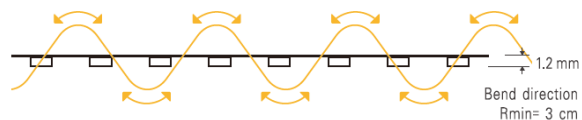
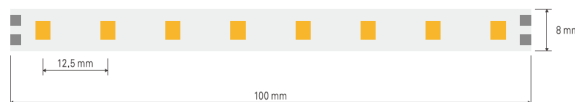

Obs.: A nossa fita de 12V/24V é vendida em rolos de 5 metros

| Referência | Potência | Led SMD | Lumens/Mt. | Temp. Cor | Voltagem | IP | CRI | Preço/mt |
|------------|----------|---------|------------|-----------|----------|----|-----|----------|
| 240/860-24 | | | 1 152 | 6000K | | | | |
| 240/840-24 | | | 1 129 | 4000K | | 20 | | |
| 240/830-24 | | | 1 002 | 3000K | | | | |
| 240/828-24 | | | 1 002 | 2800K | | | | |
| 240/822-24 | | | 1 002 | 2200K | | | | |
| 241/860-24 | 7,2W | 2835-80 | 1 152 | 6000K | 24VDC | | 80 | |
| 241/840-24 | | | 1 129 | 4000K | | 65 | | |
| 241/830-24 | | | 1 002 | 3000K | | | | |
| 241/828-24 | | | 1 002 | 2800K | | | | |
| 241/822-24 | | | 1 002 | 2200K | | | | |

8,64W/Mt.

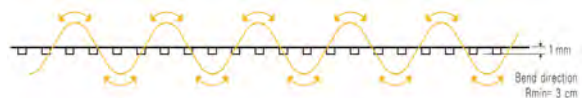

Obs.: A nossa fita de 12V/24V é vendida em rolos de 5 metros

| Referência | Potência | Led SMD | Lumens/Mt. | Temp. Cor | Voltagem | IP | CRI | Preço/mt |
|------------|------------|----------|------------|-----------|----------|----|-----|----------|
| 233/24-6 | | | 800 | 6000K | | | | |
| 233/24-4 | 8,64W/ Mt. | 2216-210 | 770 | 4000K | 24VDC | 20 | 90 | |
| 233/24-3 | | | 790 | 2800K | | | | |

9,5W/Mt.

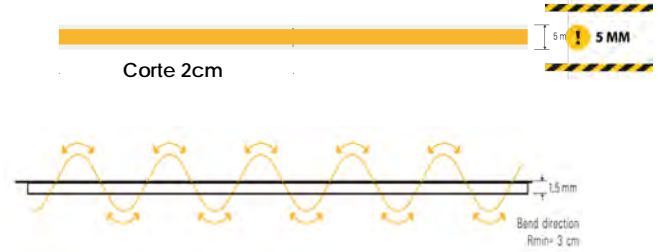

DC 24V CE 1 BIN Dimmable Ra 90 140° 3 years

Obs.: A nossa fita de 12V/24V é vendida em rolos de 5 metros

| Referência | Potência | Led SMD | Lumens/Mt. | Temp. Cor | Voltagem | IP | CRI | Preço/mt |
|--------------|-----------|-------------|------------|-----------|----------|----|-----|----------|
| 500/COB5M-6 | 9,5W/ Mt. | 400 Led/Mt. | 950 | 6000K | 24VDC | 20 | 90 | |
| 500/COB5M-4 | | | | 4000K | | | | |
| 500/COB5M-3 | | | | 3000K | | | | |
| 500/COB5M-27 | | | | 2700K | | | | |

COB 10W/Mt.

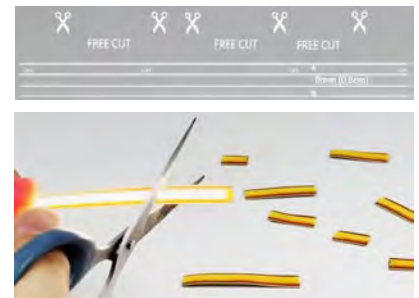
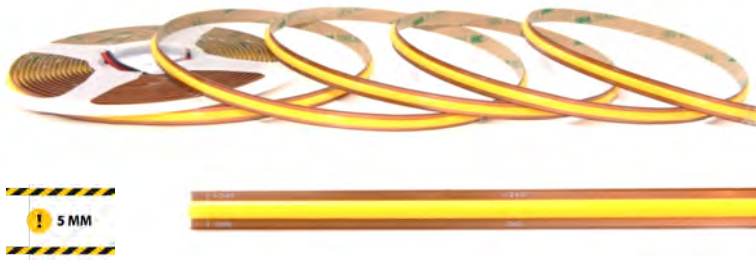

DC 24V CE 1 BIN Dimmable Ra 90 140° 3 years

Obs.: A nossa fita de 12V/24V é vendida em rolos de 5 metros

| Referência | Potência | Led SMD | Lumens/Mt. | Temp. Cor | Voltagem | IP | CRI | Preço/mt |
|---------------|----------|-------------|------------|-----------|----------|----|-----|----------|
| 500/COB5MC-6 | 10W/ Mt. | 400 Led/Mt. | 950 | 6000K | 24VDC | 20 | 90 | |
| 500/COB5MC-4 | | | 930 | 4000K | | | | |
| 500/COB5MC-27 | | | 900 | 2700K | | | | |

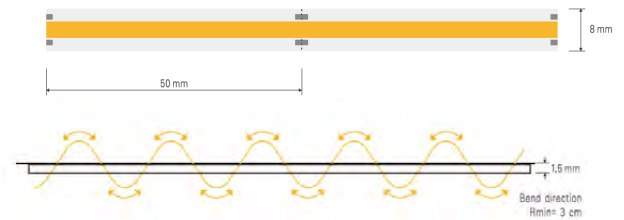

DC 24V CE 1 BIN Dimmable Ra 90 140° 3 years

Obs.: A nossa fita de 12V/24V é vendida em rolos de 5 metros

| Referência | Potência | Led SMD | Lumens/Mt. | Temp. Cor | Voltagem | IP | CRI | Preço/mt |
|-------------|------------|-------------|------------|-----------|----------|----|-----|----------|
| 500/COB-6 | 10,5W/ Mt. | | 1 005 | 6000K | 24VDC | 20 | 90 | |
| 500/COB-4 | | | 987 | 4000K | | | | |
| 500/COB-3 | | | 910 | 3000K | | | | |
| 500/COB-27 | | | 896 | 2700K | | | | |
| 500/COB-R | 11W/ Mt | 480 Led/Mt. | 900 | Vermelho | 24VDC | | 90 | |
| 500/COB-G | | | | Verde | | | | |
| 500/COB-B | | | | Azul | | | | |
| 500/COB-Y | | | | Amarelo | | | | |
| 500/COB-6S | 10W/ Mt. | | 995 | 6000K | 24VDC | 65 | | |
| 500/COB-4S | | | 987 | 4000K | | | | |
| 500/COB-3S | | | 896 | 3000K | | | | |
| 500/COB-27S | | | 890 | 2700K | | | | |

FCOB 10W/Mt.

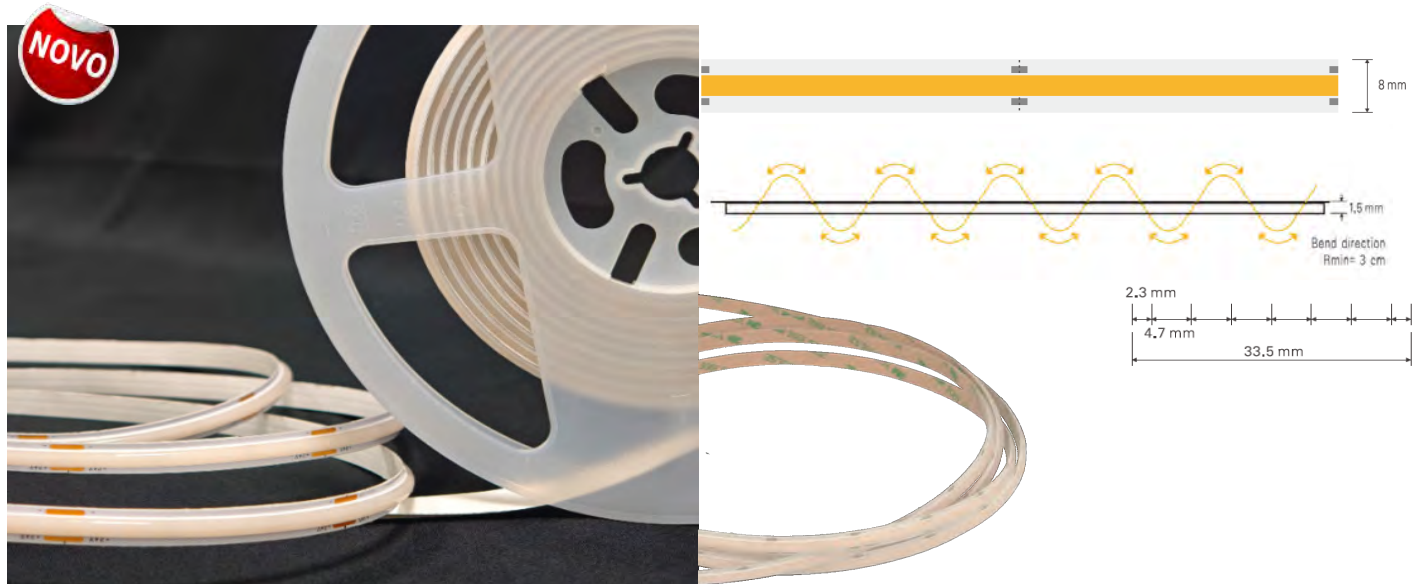

Obs.: A nossa fita de 12V/24V é vendida em rolos de 5 metros

| Referência | Potência | Led SMD | Lumens/Mt. | Temp. Cor | Voltagem | IP | CRI | Preço/mt |
|--------------|----------|-------------|------------|-----------|----------|----|-----|----------|
| 500/FSCOB-6 | | | 1 025 | 6000K | | | | |
| 500/FSCOB-4 | 10W/ Mt. | 252 Led/Mt. | 995 | 4000K | 24VDC | 20 | 90 | |
| 500/FSCOB-3 | | | 980 | 3000K | | | | |
| 500/FSCOB-27 | | | 950 | 2700K | | | | |



COB 11W/Mt. e 12W/Mt. (rolo 50mt.)

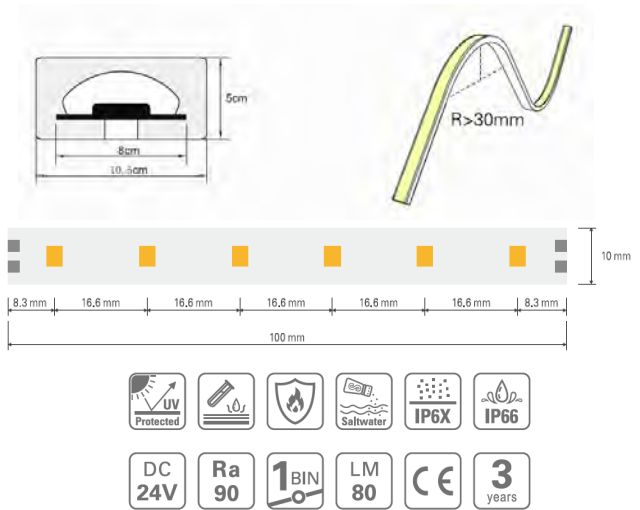

| Referência | Potência | Led SMD | Lumens/Mt. | Temp. Cor | Voltagem | IP | CRI | Preço/mt |
|--------------|-----------|-------------|------------|-----------|----------|----|-----|----------|
| 500/COB11-4M | 11W/ Mt. | 480 Led/Mt. | 805 | 4000K | 24VDC | 66 | 90 | |
| 500/COB11-3M | | | 785 | 2700K | | | | |
| 248/50RGB-24 | 12,5W/ Mt | 3838-60 | | R G B | | | | |

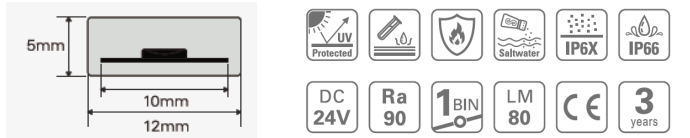
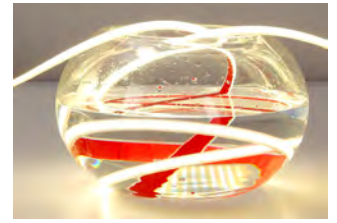
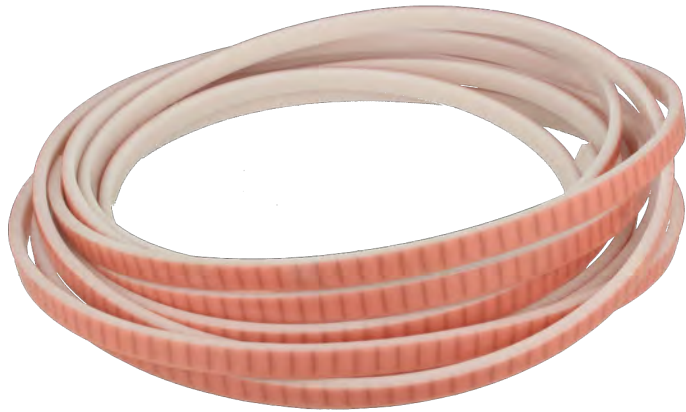

| Referência | Potência | Led SMD | Lumens/Mt. | Temp. Cor | Voltagem | IP | CRI | Preço/mt |
|-------------|----------|----------|------------|-----------|----------|----|-----|----------|
| 248/50WW-24 | 12W/ Mt | 2216-280 | 1 100 | 2700K | 24VDC | 68 | 90 | |

11,52W/Mt.

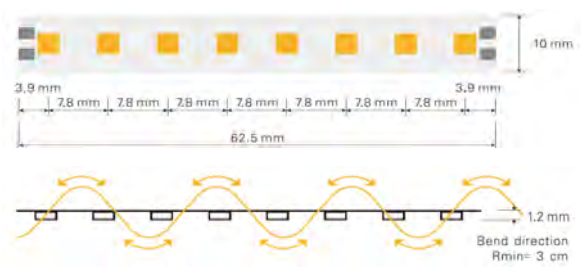

Obs.: A nossa fita de 12V/24V é vendida em rolos de 5 metros

| Referência | Potência | Led SMD | Lumens/Mt. | Temp. Cor | Voltagem | IP | CRI | Preço/mt |
|------------|------------|----------|------------|-----------|----------|----|-----|----------|
| 238/24-6 | | | 1 728 | 6000K | | 20 | | |
| 237/24-6S | 11,52W/Mt. | 2835-128 | 1 728 | 6000K | 24VDC | 65 | 80 | |
| 237/24-4S | | | 1 628 | 4000K | | | | |

12W/Mt.

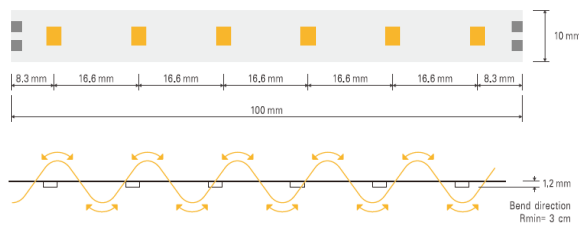

Obs.: A nossa fita de 12V/24V é vendida em rolos de 5 metros.
A referência 248/860-24 e 248/827-24 é vendida em rolos de 10 metros.



| Referência | Potência | Led SMD | Lumens/Mt. | Temp. Cor | Voltagem | IP | CRI | Preço/mt |
|------------|----------|---------|------------|-----------|----------|----|-----|----------|
| 244/W24 | | | 1 350 | 6000K | | | | |
| 244/24-840 | | | 1 250 | 4000K | | | | |
| 244/WW24 | | | 1 150 | 3000K | | 20 | | |
| 244/24-824 | | | 1 150 | 2400K | | | | |
| 244/24-822 | | | 1 150 | 2200K | | | | |
| 245/W24 | 12W/ Mt. | 2835-60 | 1 350 | 6000K | 24VDC | | 80 | |
| 245/840-24 | | | 1 250 | 4000K | | | | |
| 245/830-24 | | | 1 150 | 3000K | | 65 | | |
| 245/824-24 | | | 1 150 | 2400K | | | | |
| 245/822-24 | | | 1 150 | 2200K | | | | |
| 248/860-24 | | | 1 350 | 6000K | | 68 | | |
| 248/827-24 | | | 1 150 | 2700K | | | | |

12W/Mt. 3D

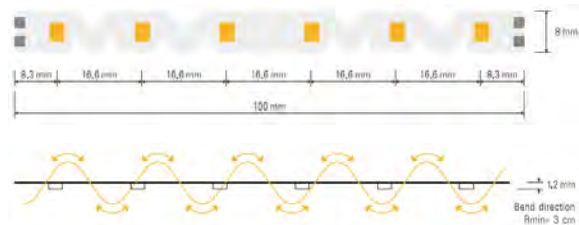

Obs.: A nossa fita de 12V/24V é vendida em rolos de 5 metros

| Referência | Potência | Led SMD | Lumens/Mt. | Temp. Cor | Voltagem | IP | CRI | Preço/mt |
|-------------|----------|---------|------------|-----------|----------|----|-----|----------|
| 244/3DPW-24 | 12W/ Mt. | 2835-60 | 1 150 | 4000K | 24VDC | 20 | 80 | |
| 244/3DWW-24 | | | 1 000 | 3000K | | | | |

13W/Mt.

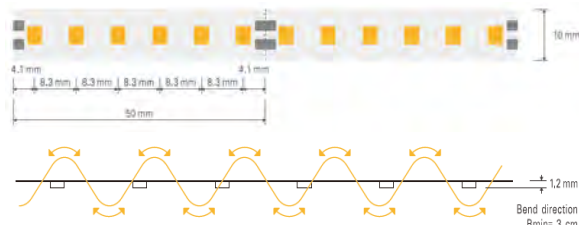
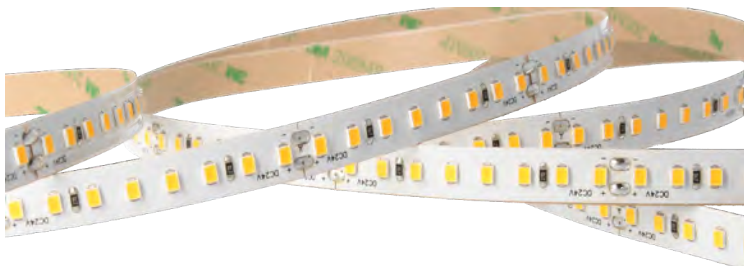

Obs.: A nossa fita de 12V/24V é vendida em rolos de 5 metros

| Referência | Potência | Led SMD | Lumens/Mt. | Temp. Cor | Voltagem | IP | CRI | Preço/mt |
|------------|----------|----------|------------|-----------|----------|----|-----|----------|
| 246/860-24 | | | 1 550 | 6000K | | | | |
| 246/840-24 | | | 1 450 | 4000K | | 20 | | |
| 246/830-24 | | | 1 350 | 3000K | | | | |
| 247/860-24 | 13W/ Mt. | 2835-120 | 1 550 | 6000K | 24VDC | | 80 | |
| 247/840-24 | | | 1 450 | 4000K | | 65 | | |
| 247/830-24 | | | 1 350 | 3000K | | | | |

15W/Mt.

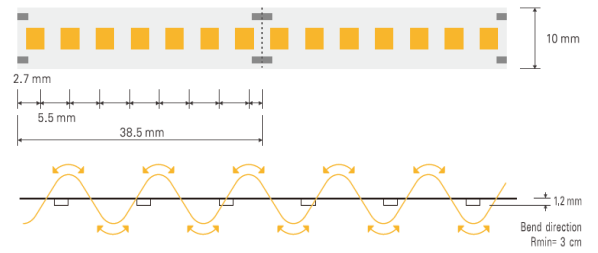

Obs.: A nossa fita de 12V/24V é vendida em rolos de 5 metros

| Referência | Potência | Led SMD | Lumens/Mt. | Temp. Cor | Voltagem | IP | CRI | Preço/mt |
|------------|----------|----------|------------|-----------|----------|----|-----|----------|
| 249/860-24 | 15W/Mt. | 2835-182 | 1 847 | 6000K | 24VDC | 20 | 90 | |
| 249/840-24 | | | 1 840 | 4000K | | | | |
| 249/830-24 | | | 1 840 | 3000K | | | | |
| 249/827-24 | | | 1 755 | 2700K | | | | |
| 249/822-24 | | | 1 587 | 2200K | | | | |
| 250/860-24 | | | 1 950 | 6000K | | | | |
| 250/840-24 | | | 1 840 | 4000K | | | | |
| 250/830-24 | | | 1 787 | 3000K | | | | |
| 250/827-24 | | | 1 755 | 2700K | | | | |
| 250/822-24 | | | 1 755 | 2200K | | | | |

COB 16W/Mt.

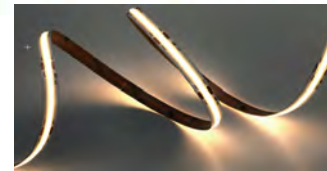
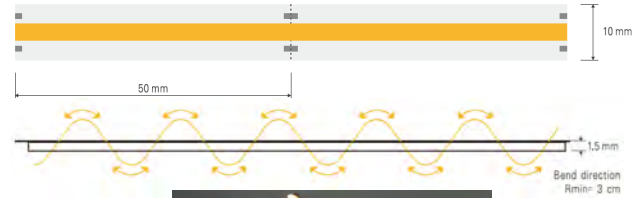

Obs.: A nossa fita de 12V/24V é vendida em rolos de 5 metros

| Referência | Potência | Led SMD | Lumens/Mt. | Temp. Cor | Voltagem | IP | CRI | Preço/mt |
|---------------|------------|-------------|------------|-----------|----------|----|-----|----------|
| 500/COB16-6 | 16W/ Mt. | 480 Led/Mt. | 1 680 | 6000K | 24VDC | 20 | 90 | |
| 500/COB16-4 | | | 1 680 | 4000K | | | | |
| 500/COB16-3 | | | 1 650 | 3000K | | | | |
| 500/COB16-27 | | | 1 650 | 2700K | | | | |
| 500/COB16-23 | | | 1 610 | 2300K | | | | |
| 500/COB16-6S | | | 1 680 | 6000K | | | | |
| 500/COB16-4S | | | 1 680 | 4000K | | | | |
| 500/COB16-3S | | | 1 650 | 3000K | | | | |
| 500/COB16-27S | | | 1 650 | 2700K | | | | |
| 500/COB16-23S | | | 1 610 | 2300K | | | | |
| 501/860-24 | 14,4W/ Mt. | | 1 550 | 6000K | | 67 | | |
| 501/827-24 | 16W/ Mt. | | 1 350 | 2700K | | | | |

19,2W/Mt.

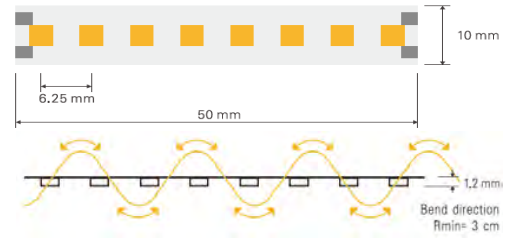

Obs.: A nossa fita de 12V/24V é vendida em rolos de 5 metros

| Referência | Potência | Led SMD | Lumens/Mt. | Temp. Cor | Voltagem | IP | CRI | Preço/mt |
|-------------|------------|----------|------------|-----------|----------|----|-----|----------|
| 242N/860-24 | 19,2W/ Mt. | 2835-160 | 2 496 | 6000K | 24VDC | 20 | 80 | |
| 242N/840-24 | | | 2 400 | 4000K | | | | |
| 242N/830-24 | | | 2 326 | 3000K | | | | |
| 243N/860-24 | 19,2W/ Mt. | 2835-160 | 2 496 | 6000K | 24VDC | 65 | 80 | |
| 243N/840-24 | | | 2 400 | 4000K | | | | |
| 243N/830-24 | | | 2 326 | 3000K | | | | |

3CCT 22W/Mt.

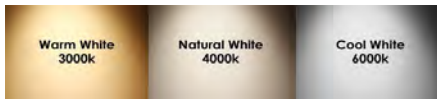
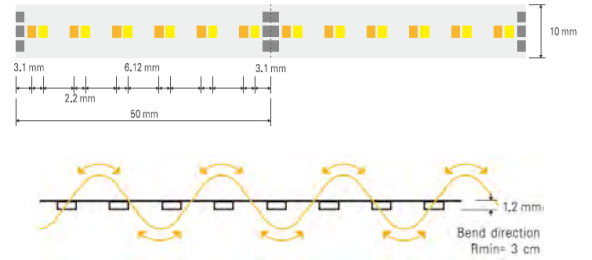
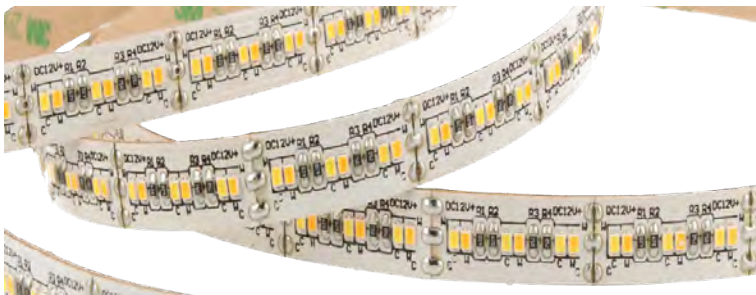

Obs.: A nossa fita de 12V/24V é vendida em rolos de 5 metros



| Referência | Potência | Led SMD | Lumens/Mt. | Temp. Cor | Voltagem | IP | CRI | Preço/mt |
|------------|----------|----------|------------|-------------------|----------|----|-----|----------|
| 232/CCT-24 | 22W/mt | 2216-240 | 2 100 | 3000K+4000K+6000K | 24VDC | 20 | 80 | |

26W/Mt.

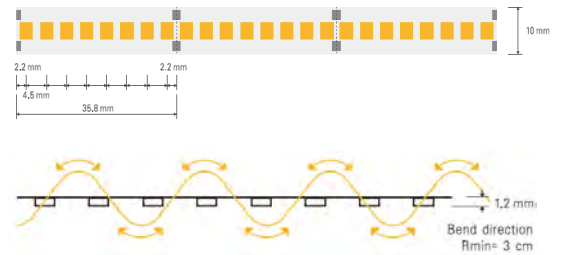

Obs.: A nossa fita de 12V/24V é vendida em rolos de 5 metros

| Referência | Potência | Led SMD | Lumens/Mt. | Temp. Cor | Voltagem | IP | CRI | Preço/mt |
|-------------|----------|----------|------------|-----------|----------|----|-----|----------|
| 236N/860-24 | 26W | 2835-224 | 3 770 | 6000K | 24VDC | 20 | 80 | |
| 236N/840-24 | | | 3 700 | 4000K | | | | |
| 236N/828-24 | | | 3 630 | 2800K | | | | |

RGB 8W/Mt.

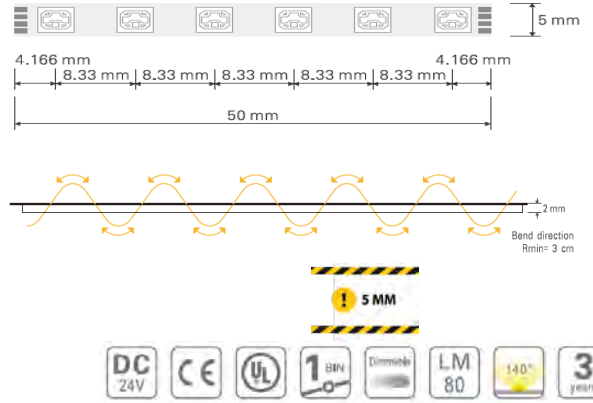

| Referência | Potência | Led SMD | Lumens/Mt. | Temp. Cor | Voltagem | IP | CRI | Preço/mt |
|------------|----------|----------|------------|----------------------------|----------|----|-----|----------|
| 246/5M-RGB | 8W/ Mt | 3838-120 | | R G B | 24VDC | 20 | 80 | |

RGB COB 10W/Mt.

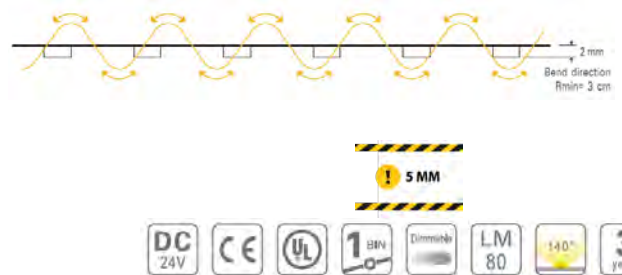

Obs.: A nossa fita de 12V/24V é vendida em rolos de 5 metros

| Referência | Potência | Led SMD | Lumens/Mt. | Temp. Cor | Voltagem | IP | CRI | Preço/mt |
|----------------|----------|---------|------------|----------------------------|----------|----|-----|----------|
| 500/COB5M-RGB | 10W/ Mt. | 576 | | R G B | 24VDC | 20 | 80 | |
| 500/COB5M-RGBS | | | | | | 65 | | |

RGB 12W/Mt.



Obs.: A nossa fita de 12V/24V é vendida em rolos de 5 metros

| Referência | Potência | Led SMD | Lumens/Mt. | Temp. Cor | Voltagem | IP | CRI | Preço/mt |
|------------|----------|---------|------------|----------------------------|----------|----|-----|----------|
| 248/RGB-24 | 12W/ Mt. | 3838-60 | | R G B | 24VDC | 68 | 80 | |

RGB 13W/Mt.

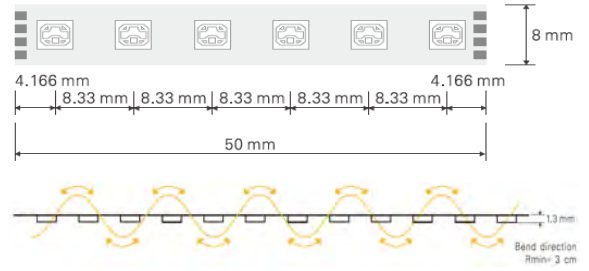

Obs.: A nossa fita de 12V/24V é vendida em rolos de 5 metros

| Referência | Potência | Led SMD | Lumens/Mt. | Temp. Cor | Voltagem | IP | CRI | Preço/mt |
|------------|----------|----------|------------|-----------|----------|----|-----|----------|
| 246/RGB-24 | 13W/ Mt. | 3838-120 | | R G B | 24VDC | 20 | 80 | |
| 247/RGB-24 | | | | | | 65 | | |

RGB COB 14W/Mt.

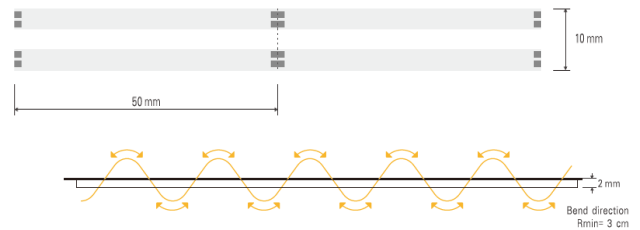

Obs.: A nossa fita de 12V/24V é vendida em rolos de 5 metros

| Referência | Potência | Led SMD | Lumens/Mt. | Temp. Cor | Voltagem | IP | CRI | Preço/mt |
|--------------|----------|-------------|------------|-----------|----------|----|-----|----------|
| 500/COB-RGB | 14W/ Mt | 840 Led/Mt. | | R G B | 24VDC | 20 | 90 | |
| 500/COB-RGBS | | | | | | 65 | | |

RGB 14,4W/Mt.

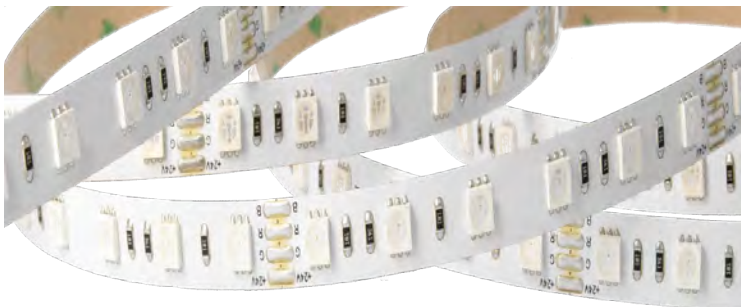

Obs.: A nossa fita de 12V/24V é vendida em rolos de 5 metros

| Referência | Potência | Led SMD | Lumens/Mt. | Temp. Cor | Voltagem | IP | CRI | Preço/mt |
|------------|------------|---------|------------|-----------|----------|----|-----|----------|
| 292/RGB24 | 14,4W/ Mt. | 5050-60 | | R G B | 24VDC | 20 | 80 | |
| 299/RGB24 | | | | | | 65 | | |

RGB 18W/Mt.

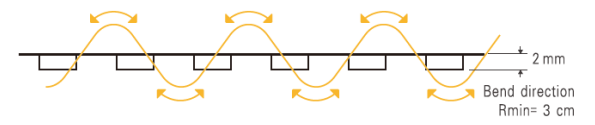
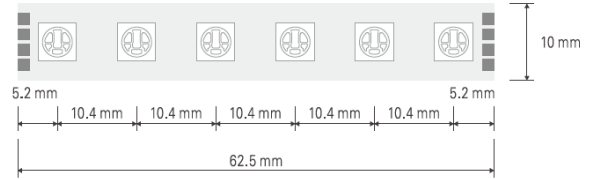

| Referência | Potência | Led SMD | Lumens/Mt. | Temp. Cor | Voltagem | IP | CRI | Preço/mt |
|------------|------------|---------|------------|-----------|----------|----|-----|----------|
| 293/RGB-24 | 18,4W/ Mt. | 5050-96 | 1 250 | R G B | 24VDC | 20 | 80 | |

RGB+W / RGB+CCT 18W/Mt.

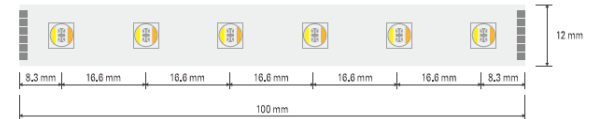

| Referência | Potência | Led SMD | Lumens/Mt. | Temp. Cor | Voltagem | IP | CRI | Preço/mt |
|------------|------------|---------|------------|---------------------------|----------|----|-----|----------|
| 315/24 | 19,2W/ Mt. | 5050-60 | 1 250 | R G B + 3000K+4000K+6000K | 24VDC | 20 | 80 | |
| 313/24 | 17,2W/ Mt. | 5050-60 | 1 300 | R G B +6000K | | | | |

RGB+W / RGB+CCT COB 18W/Mt.

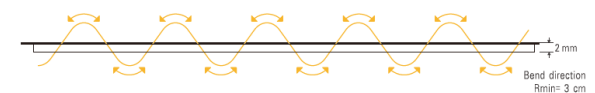

Obs.: A nossa fita de 12V/24V é vendida em rolos de 5 metros

| Referência | Potência | Led SMD | Lumens/Mt. | Temp. Cor | Voltagem | IP | CRI | Preço/mt |
|-------------|----------|---------------|------------|---------------------------|----------|----|-----|----------|
| 315/COB-24 | | | 1 300 | R G B + 3000K+4000K+6000K | | | | |
| 313/COB-24 | 18W/ Mt | COB-784led/mt | 1 250 | R G B +6000K | 24VDC | 20 | 90 | |
| 315/COB-24S | | | 1 300 | R G B + 3000K+4000K+6000K | | 65 | | |

WallWasher 15W/Mt. e 42W/Mt. (Premium)



Obs.: A nossa fita de 12V/24V é vendida em rolos de 5 metros

| Referência | Potência | Led SMD | Lumens/Mt. | Temp. Cor | Voltagem | IP | CRI | Preço/mt |
|------------|--------------------------|---------|------------|---------------------------------------|----------|----|-----|----------|
| 502/827-24 | 15W/ Mt. | 2835-42 | 1 350 | 2700K | 24VDC | 67 | 80 | |
| 502/860-24 | | | | 6000K | | | | |
| 502/RGB-24 | 42W/ Mt. | 3030-36 | | R G B | | | | |
| 502/KIT | Kit para Fita modelo 502 | | | Composto por 1 Topo C/Furo e 1 S/Furo | | | | |

UV 12W/Mt.



| Referência | Potência | Led SMD | Lumens/Mt. | Temp. Cor | Voltagem | IP | CRI | Preço/mt |
|------------|----------|---------|------------|-----------|----------|----|-----|----------|
| 244/UV | 12W/ Mt. | 2835-60 | 405nm | UV | 24VDC | 20 | 80 | |

MEAT 13W/Mt.



Obs.: A nossa fita de 12V/24V é vendida em rolos de 5 metros

| Referência | Potência | Led SMD | Lumens/Mt. | Temp. Cor | Voltagem | IP | CRI | Preço/mt |
|-------------|----------|----------|------------|-----------|----------|----|-----|----------|
| 244/MEAT120 | 13W/ Mt. | 2835-120 | | 3100K | 24VDC | 20 | 80 | |
| 245/MEAT | | | | 66 | | | | |

RGB Digital 14,4W/Mt. e 23,4W/Mt. (Premium)

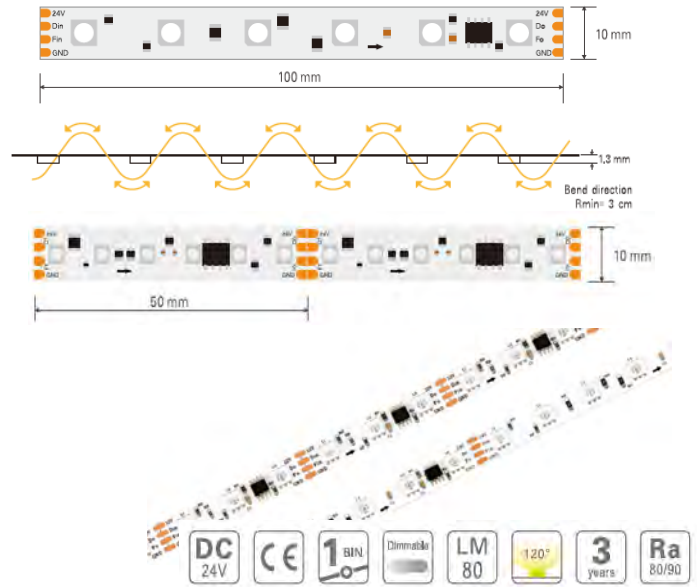

Obs.: A nossa fita de 12V/24V é vendida em rolos de 5 metros

| Referência | Potência | Led SMD | Lumens/Mt. | Temp. Cor | Voltagem | IP | CRI | Preço/mt |
|------------|----------|----------|------------|-----------|----------|----|-----|----------|
| 278 | 14,4W | 5050-60 | 10/mt | R G B | 24VDC | 20 | 80 | |
| 279 | 23,4W | 2835-120 | 20/mt | | | | | |



SP53AE+RB4



Obs.: A nossa fita de 12V/24V é vendida em rolos de 5 metros

| Referência | Potência | Led SMD | Lumens/Mt. | Temp. Cor | Voltagem | IP | CRI | Preço/mt |
|------------|----------|---------|------------|-------------|----------|----|-----|----------|
| 279/COB-DS | 23,4W | COB | 24/mt | R G B + CCT | 24V | 20 | 80 | |

| Referência | Potência | Led SMD | Descrição | Base | Dimensão | Preço |
|------------|----------|-----------|-----------------|----------|------------|-------|
| SP53AE+RB4 | 5-24VDC | 600PX Max | SPI RGB+CCT IoT | Plástico | 78X56X20mm | |

Digital 10W/Mt.

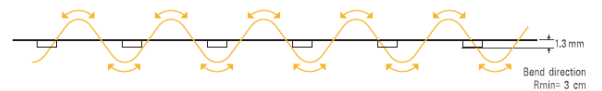
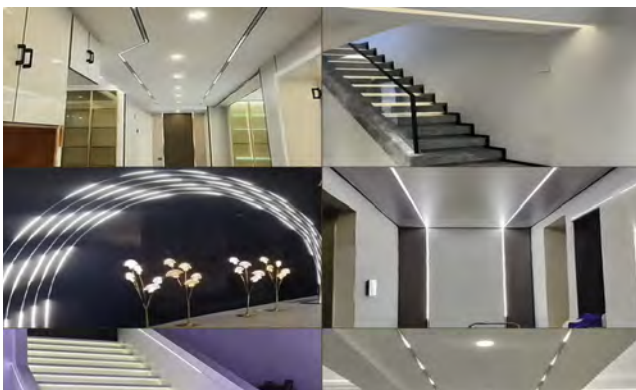

Obs.: A nossa fita de 12V/24V é vendida em rolos de 5 metros

| Referência | Potência | Led SMD | Lumens/Mt. | Temp. Cor | Voltagem | IP | CRI | Preço/mt |
|------------|----------|----------|------------|-----------|----------|----|-----|----------|
| 280/827-24 | 10W | 2835-120 | 8/mt | 2700K | 24VDC | 20 | 80 | |
| 280/840-24 | | | | 4000K | | | | 107 |

24

Fitas LED 230V

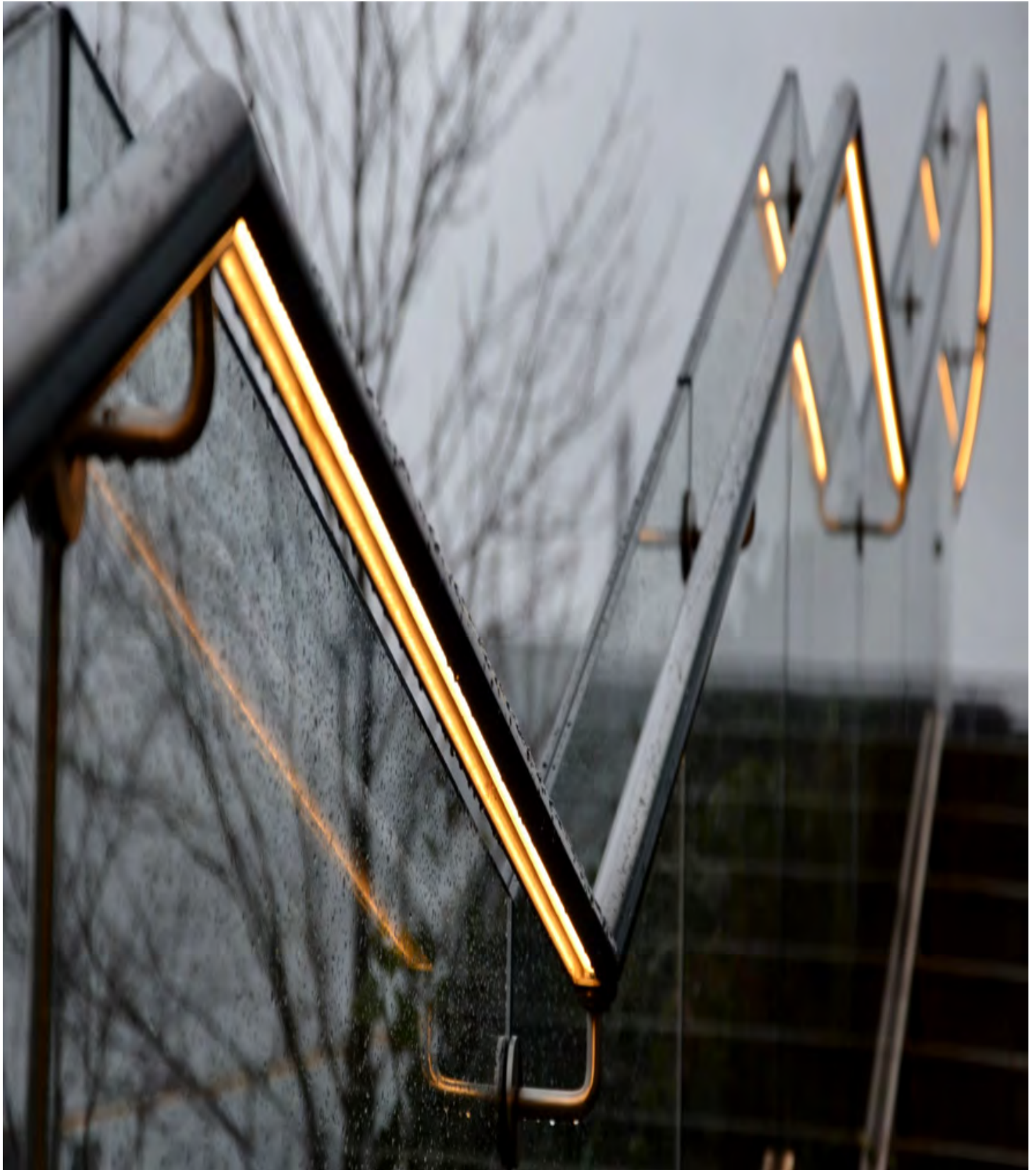

COB 11W/Mt.

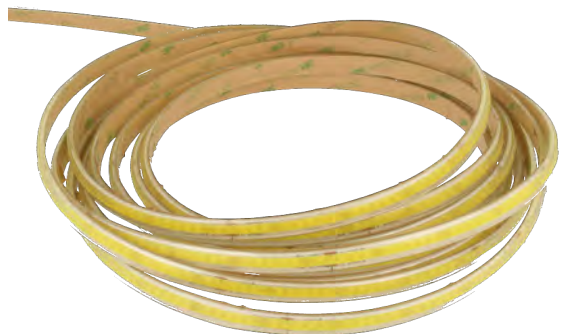

12,5cm



| Referência | Potência | Lumens/Mt. | Temp. Cor | Preço/Mt |
|-------------|--------------|------------|---------------|----------|
| 555/COB10-6 | 11W/ Mt. | 1 100 | 6000K | |
| 555/COB10-4 | | 1 050 | 4000K | |
| 555/COB10-3 | | 1 000 | 3000K | |
| Led SMD | Voltagem | Corte | Dimensão | |
| COB | 200 - 250VAC | 12,5 | 9,95 x 5,52mm | |

Obs: Precisa de Kit ligação 559/COB.
Não são aceites devoluções de cortes de fita.

559/COB-10

Kit Ligação - 50MT Fita

COB 10W/MT.



50CM



| Referência | Potência | Lumens/Mt. | Temp. Cor | Preço/Mt |
|-------------|--------------|------------|----------------|-------------------------|
| 555/COBM-6 | 10W/ Mt. | 1 250 | 6000K | |
| 555/COBM-4 | | 1 200 | 4000K | |
| 555/COBM-27 | | 1 100 | 2700K | |
| 555/COBM-R | | | Vermelho | |
| 555/COBM-B | | | Azul | |
| Led SMD | Voltagem | Corte | Dimensão | |
| COB | 200 - 250VAC | 50cm | 11,84 x 5,94mm | |
| 559/COB | | | | Kit Ligação - 50MT Fita |

Obs: Precisa de Kit ligação 559/COB.
Não são aceites devoluções de cortes de fita.

Acessórios

Obs: Braçadeira c/ 2 furos para aplicação de todas as fitas 230VAC.



559/1

Braçadeira

Obs: Topos para aplicação de todas as fitas 230VAC.



559/2

Topo Final

| Referência | Tipo | Preço |
|------------|------|-------|
|------------|------|-------|

COB 12W/MT.



NOVO

| Referência | Potência | Lumens/Mt. | Temp. Cor | Preço/Mt |
|------------|--------------|------------|-----------|----------|
| 557/COB-4 | 12W/ Mt. | 1 392 | 4000K | |
| 557/COB-3 | | 1 308 | 3000K | |
| Led SMD | Voltagem | Corte | Dimensão | Material |
| COB-296Led | 200 - 250VAC | 12,5cm | 10,5mm | Silicone |

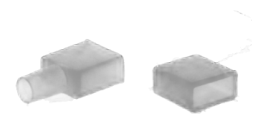
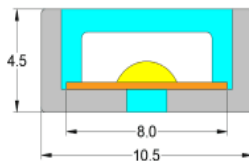

Obs: Precisa de Kit ligação 557/KIT

Fita Led 230VAC SMD2835



| Referência | Potência | Lumens/Mt. | Temp. Cor | Preço/Mt |
|------------|--------------|------------|-----------|----------|
| 557/860 | | 1 850 | 6000K | |
| 557/840 | 17W/ Mt. | 1 820 | 4000K | |
| 557/830 | | 1 821 | 2700K | |
| Led SMD | Voltagem | Corte | Dimensão | Material |
| 2835-120 | 200 - 250VAC | 10cm | 12mm | Silicone |

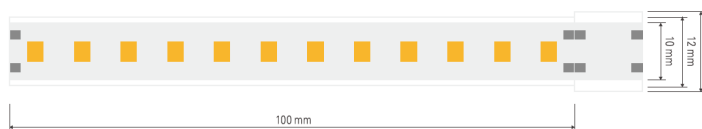

| Referência | Descrição | Preço |
|------------|----------------------------------|-------|
| 557/KIT | Kit C/ Topo Inicial + Topo Final | |



Compatível com: SW-S3 + SW-RT4



| Referência | Potência | Temp. Cor | Led SMD | Voltagem | Material | Corte | Dimensão | Preço/Mt |
|------------|----------|-----------|---------|--------------|----------|-------|----------|----------|
| 557/RGB | 10W/Mt. | R G B | 2835-96 | 200 - 250VAC | Silicone | 50cm | 14 x 5mm | |

| Referência | Descrição | Preço |
|-------------|----------------------------------|-------|
| 557/KIT-RGB | Kit C/ Topo Inicial + Topo Final | |

Controlador Dimmer 230VAC P/Fita Led

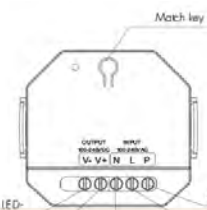

Sinal de Entrada
Alcance
Compatibilidade

RF(2,4GHz)
>30 Mt
Comando Gama SW

Temp. Func. 3x.+55°C
Índice de Proteção IP20
Certificado CE , RoHS , EMC , LVD

| Referência | Alimentação | Saída | Saída Máx. | Push | Função | Dimensão | Preço |
|------------|-------------|----------------|-------------------|------|--------|----------------|-------|
| SW-S1-HV | 100-240VAC | 1 Canal x 1.7A | 100-240VAC / 360W | Sim | Dimmer | 52 x 52 x 27mm | |

25

El Wire - Neon Flex



Fio Electroluminescente (El Wire)

Obs: O fio El Wire funciona somente com conversor, não é possível conectar directamente. A tensão varia consoante o comprimento do fio. Este fio é vendido ao metro, com quantidade mínima de 3 metros. Não se aceitam devoluções de cortes de fio.



| Referência | Cor | Voltagem | Preço |
|------------|----------|----------|-------|
| 596 | Limão | 80-90VAC | |
| 597 | Laranja | | |
| 598 | Sky Blue | | |
| 599 | Vermelho | | |
| 600 | Pink | | |
| 602 | Verde | | |
| 603 | Azul | | |
| 604 | Violeta | | |

| Frequência | C° Funcionamento | Dimensão | Material |
|---------------|--------------------|----------|----------|
| 1000 - 2000HZ | -40° a 80° Celsius | Ø 2,3mm | Silicone |

Conversores para El Wire



| Referência | Potência | Voltagem | Funcionalidade | Dimensão | Preço |
|------------|--------------|----------|----------------|----------------|-------|
| 611 | 5 mt El Wire | 12VDC | Estático | 53 x 33 x 29mm | |



| Referência | Potência | Voltagem | Funcionalidade | Dimensão |
|------------|---------------|----------|----------------|----------------|
| 612 | 10 mt El Wire | 12VDC | Estático | 53 x 33 x 29mm |



| Referência | Potência | Voltagem | Funcionalidade | Dimensão |
|------------|---------------|----------|----------------|----------------|
| 606 | 10 mt El Wire | 230VAC | Estático | 70 x 47 x 45mm |



| Referência | Potência | Voltagem | Funcionalidade | Dimensão |
|------------|---------------|----------|----------------|-----------------|
| 607 | 30 mt El Wire | 230VAC | Estático | 136 x 90 x 27mm |



| Referência | Potência | Voltagem | Funcionalidade | Dimensão |
|------------|---------------|----------|----------------|------------------|
| 608 | 50 mt El Wire | 230VAC | Estático | 141 x 100 x 33mm |



| Referência | Potência | Voltagem | Funcionalidade | Dimensão |
|------------|-----------------|----------|----------------|------------------|
| 609 | 1000 mt El Wire | 230VAC | Estático | 148 x 100 x 34mm |

Neon Flex 24V

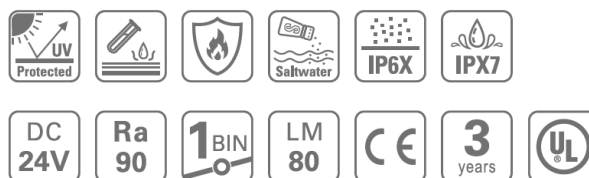
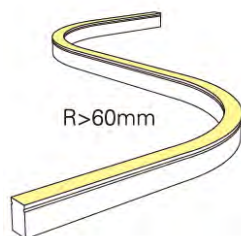
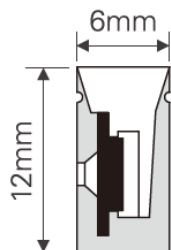

Obs: Rolo de 50 mt, quantidade mínima 1 mt. Versão "5M" vendida em rolos de 5 metros. Não são aceites devoluções de cortes de Neon.

| Referência | Potência | Lumens | Temp. Cor | Led | Voltagem | Corte | Dimensão Ø | Preço/Mt |
|--------------|----------|-----------|-----------|--------------|----------|-------|------------|----------|
| NE24V-3 | | | 3000K | | | | | |
| NE24V-4 | | | 4000K | | | | | |
| NE24V-5 | | | 5000K | | | | | |
| NE24V-RED | | | Vermelho | | | | | |
| NE24V-BLUE | 12W | 850 Lm/Mt | Azul | SMD 2835-120 | 24VDC | 5cm | 6 x 12mm | |
| NE24V-RGB | | | R G B | | | | | |
| NE24V-3-5M | | | 3000K | | | | | |
| NE24V-4-5M | | | 4000K | | | | | |
| NE24V-RGB-5M | | | R G B | | | | | |

Accessórios Neon Flex



| Referência | Acessório | Descrição | Dimensão | Preço/Mt |
|------------|-----------|-------------------------------------|-------------------|----------|
| 777/NE24 | Perfil | Perfil de Alumínio dobrável | 1000 x 8 x 12,2mm | |
| 777/5M | Perfil | Perfil de Alumínio | 1000 x 8 x 13,5mm | |
| Referência | Acessório | Descrição | Dimensão | Preço |
| TP-NE24 | Kit | Kit ligação composto por dois topos | 20 x 14 x 17mm | |

Neon Flex 24V

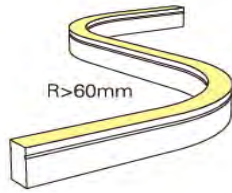
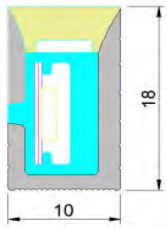

Obs: Rolo de 50 mt, vendido ao metro. Não são aceites devoluções de cortes de Neon.

| Referência | Potência | Lumens | Temp. Cor | Dimensões | Preço/Mt |
|---------------|-----------|-------------------------------------|-----------|-----------|----------|
| NE24V-1018-27 | 12W | 750 Lm/Mt | 2700K | 18 x 10mm | |
| Referência | Acessório | Descrição | | | |
| TP-NE1018 | KIT | Kit ligação composto por dois topos | | | |



Neon Flex 24V

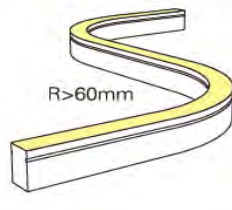
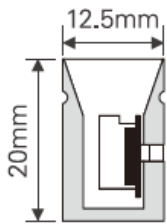
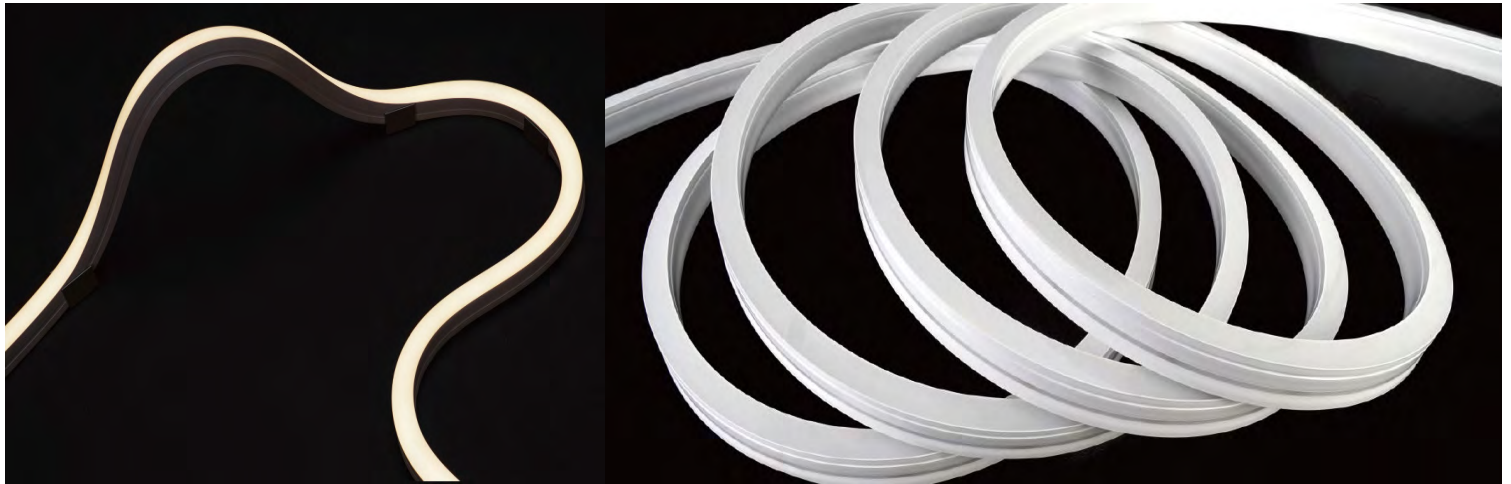

| | | | | | | |
|--|--|--|--|--|--|--|
| | | | | | | |
| | | | | | | |

Obs: Rolo de 50 mt, vendido ao metro. Não são aceites devoluções de cortes de Neon.

| Referência | Potência | Lumens | Temp. Cor | Dimensões | Preço/Mt |
|---------------|----------|-----------|-----------|-------------|----------|
| NE24V-1220-27 | 12W | 750 Lm/Mt | 2700K | 20 x 12,5mm | |

| Referência | Acessório | Descrição |
|------------|-----------|-------------------------------------|
| TP-NE1220 | KIT | Kit ligação composto por dois topos |

Neon Flex 24V

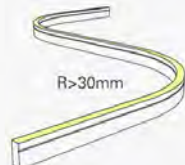
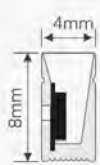

| | | | | | | |
|--|--|--|--|--|--|--|
| | | | | | | |
| | | | | | | |

Obs: Rolo de 50 mt, vendido ao metro. Não são aceites devoluções de cortes de Neon.

| Referência | Potência | Lumens | Temp. Cor | Dimensões | Preço/Mt |
|---------------|----------|-----------|-----------|-----------|----------|
| NE24V-0408-27 | 10W | 750 Lm/Mt | 2700K | 8 x 4mm | |
| NE24V-0408-4 | | | 4000K | | |

| Referência | Acessório | Descrição | Preço |
|------------|-----------|-------------------------------------|-------|
| TP-NE0408 | KIT | Kit ligação composto por dois topos | |
| AC-NE0408 | Fixadores | Fixadores de Alumínio | |

Neon Flex 360°

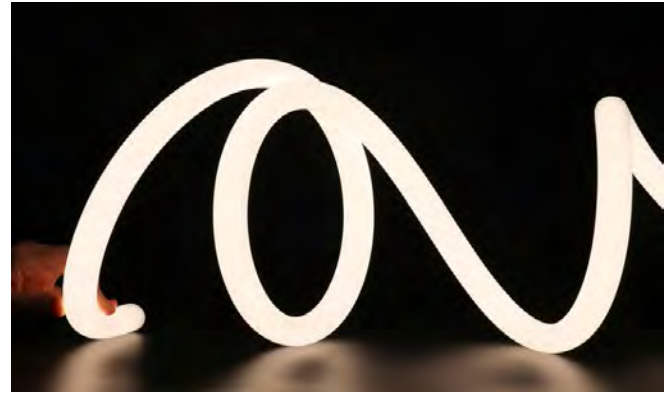

Obs: Vendido em rolos de 5mt.

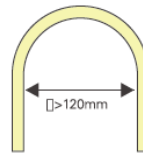
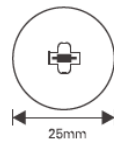

| Referência | Potência | Lumens | Temp. Cor | Led | Voltagem | Corte | Preço/mt |
|------------|----------|-----------|-----------|--------------|----------|--------|----------|
| NE24-D25-4 | 14W | 1005Lm/Mt | 4000K | SMD 2835-320 | 24VDC | 6,25cm | |
| NE24-D25-3 | | 994 Lm/Mt | 3000K | | | | |

Acessórios Neon Flex

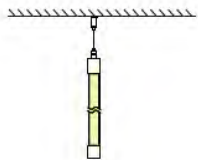

Vertical pendant accessory Kit



| Referência | Observação | Preço |
|------------|-------------------|-------|
| FP-D25-1 | Pendente Vertical | |

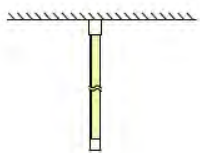

Vertical surface mounted accessory kit



| Referência | Observação | Preço |
|------------|---------------------|-------|
| FP-D25-3 | Superfície Vertical | |

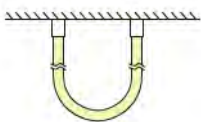

Double ended Vertical surface mounted accessory kit



| Referência | Observação | Preço |
|------------|---------------------------------------|-------|
| FP-D25-5 | Superfície Vertical c/ dois fixadores | |

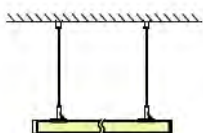

Horizontal pendant accessory Kit

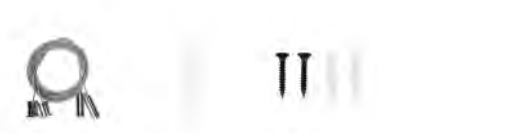

| Referência | Observação | Preço |
|------------|----------------------|-------|
| FP-D25-6 | Suspensão Horizontal | |

Tubo de Silicone

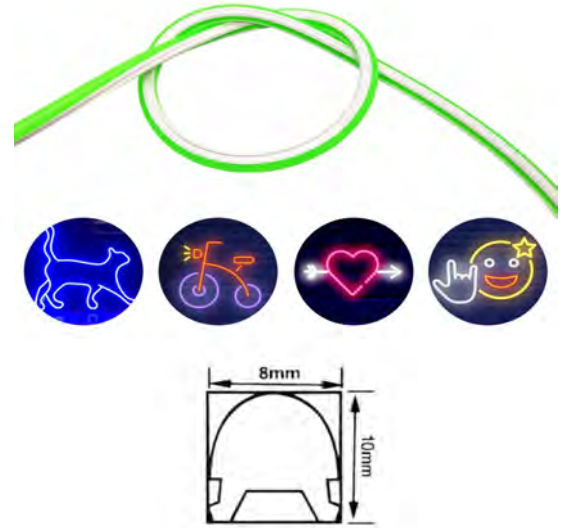

Obs: Rolo de 100 mt, vendido ao metro. Compatível com Fita Led de 5mm e 8mm. Não são aceites devoluções de cortes.

| Referência | Cor | Dimensões | Preço/Mt |
|------------|----------|-----------|----------|
| ST-WHITE | Branco | 10 x 8mm | |
| ST-RED | Vermelho | | |
| ST-GREEN | Verde | | |
| ST-BLUE | Azul | | |
| ST-YELLOW | Amarelo | | |



| Referência | Tipo | Descrição | Dimensão | Preço |
|------------|----------|-----------|----------|-------|
| Fresa-A | Acrílico | Fresa | 8mm | |
| Fresa-M | Madeira | | | |



KIT Dimmer



Obs: Comando touch; Dimming suave de 0-100%; Tecnologia Wireless 2,4GHz com capacidade até 30 metros.

| Referência | Potência | Saída | Saída Máx. | Push Dim | Material | Dimensão | Preço |
|---------------|----------|--------------|----------------------------|----------|----------|----------------|-------|
| SW-R6-1+SW-V1 | 12-24VDC | 1 Canal x 8A | 12VDC - 96W / 24VDC - 192W | Sim | Plástico | 97 x 33 x 18mm | |

| | |
|---------------------|---------------------|
| Sinal de saída | RF(2,4GHz) |
| Alimentação | 3VDC (CR2032) |
| Duração em Standby | 1 Ano |
| Alcance | >30 Mt |
| Temp. Funcionamento | min. -30 max. +55°C |
| Dimensões | 107 x 58,5 x 9mm |
| Peso | 34g |

KIT RGB+W

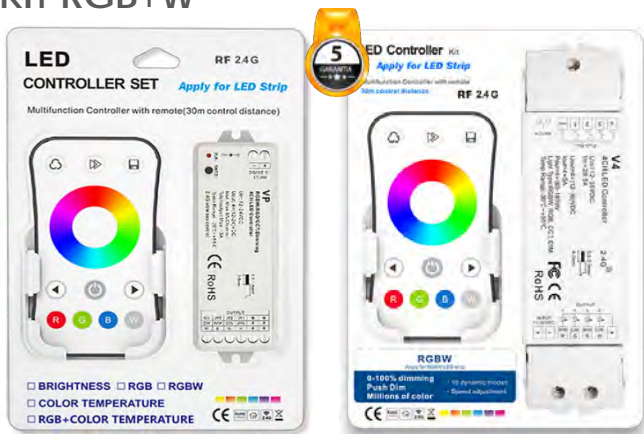

Obs: Comando touch; RGB até 16 Milhões de cores; Inclui 10 Modos Dinâmicos; Tecnologia Wireless 2,4GHz com capacidade até 30 mt.

| Referência | Potência | Saída | Saída Máx. | Push Dim | Função | Dimensão | Preço |
|------------|----------|---------------|-----------------------------|----------|--------|-------------|-------|
| SW-R8+VP | 12-24VDC | 4 Canais x 4A | 12VDC - 192W / 24VDC - 384W | Não | RGB+W | 114x38x20mm | |
| SW-R8+V3 | | 3 Canais x 4A | 12VDC - 144W / 24VDC - 288W | | | | |

| | |
|---------------------|---------------------|
| Sinal de saída | RF(2,4GHz) |
| Alimentação | 3VDC (CR2032) |
| Duração em Standby | 1 Ano |
| Alcance | >30 Mt |
| Temp. Funcionamento | min. -30 max. +55°C |
| Dimensões | 107 x 58,5 x 9mm |
| Peso | 34g |

Comando 1 zona - RGB+W / SPI



Obs: Comando touch; Dimming suave de 0-100%; Tecnologia Wireless 2,4GHz com capacidade até 30 metros.

| Referência | Compatibilidade | Função | Dimensão | Preço |
|------------|-----------------------------------|--------|-------------------|-------|
| SW-R9 | SW-VP / SW-V4 / SW-V5 / SW-WT-SPI | RGB+W | 122 x 53 x 17,5mm | |

| | |
|---------------------|---------------------|
| Sinal de saída | RF(2,4GHz) |
| Alimentação | 3VDC (CR2032) |
| Duração em Standby | 1 Ano |
| Alcance | >30 Mt |
| Temp. Funcionamento | min. -30 max. +55°C |
| Dimensões | 107 x 58,5 x 9mm |
| Peso | 34g |

Comando 1 zona - RGB+W / SPI



| | |
|---------------------|-----------------------------|
| Sinal de saída | RF(2,4GHz) |
| Alimentação | 3VDC (CR2032) |
| Duração em Standby | 1 Ano |
| Alcance | >30 Mt |
| Temp. Funcionamento | min. -30 max. +55°C |
| Zonas de Controlo | 1 Zona |
| Índice de Proteção | IP20 |
| Certificado | CE , RoHS , EMC , LVD , RED |

Obs: Comando touch RGB até 16 Milhões de cores; Inclui 10 Modos Dinâmicos; Tecnologia Wireless 2,4GHz com capacidade até 30 mt.

| Referência | Compatibilidade | Função | Dimensão | Preço |
|------------|-----------------------------------|--------|-------------------|-------|
| SW-RT1 | Todos os Controladores da Gama SW | Dimmer | 122 x 53 x 17,5mm | |
| SW-RT4 | SW-VP / SW-V4 / SW-V5 | RGB+W | | |

Comando 4 zonas - RGB+W / CCT / DIMMER / RGB+CCT



| | | | |
|--------------------|----------------|---------------------|-----------------------------|
| Sinal de saída | RF(2,4GHz) | Temp. Funcionamento | min. -30 max. +55°C |
| Alimentação | 3VDC (AAA x 2) | Zonas de Controlo | 4 Zonas |
| Duração em Standby | 2 Anos | Certificado | CE , RoHS , EMC , LVD , RED |
| Alcance | >30 Mt | Índice de Proteção | IP20 |

| Referência | Compatibilidade | Função | Dimensão | Preço |
|------------|-----------------------------------|---------|-------------------|-------|
| SW-RT6 | Todos os controladores da gama SW | Dimmer | 122 x 53 x 17,5mm | |
| SW-RT7 | SW-VP / SW-V4 / SW-V5 | CCT | | |
| SW-RT9 | SW-VP / SW-V4 / SW-V5 | RGB+W | | |
| SW-RT10 | SW-V5 | RGB+CCT | | |

Comando 1 u 4 zonas ON-OFF e Dimmer



R11

R1-1



| | |
|---------------------|----------------------|
| Sinal de saída | RF(2,4GHz) |
| Alimentação | 3VDC (AAA x 2) |
| Duração em Standby | 2 Anos |
| Alcance | >30 Mt |
| Temp. Funcionamento | min. -30 max. +55°C |
| Zonas de controlo | 4 Zonas / 1 Zona |
| Certificado | CE , EMC , LVD , RED |
| Índice de Proteção | IP20 |

| Referência | Compatibilidade | Função | Dimensão | Preço |
|------------|-----------------------------------|-----------------|-----------------|-------|
| SW-RU4 | Todos os controladores da gama SW | ON/OFF e Dimmer | 135 x 40 x 11mm | |
| SW-R11 | | | | |
| SW-R1-1 | | | | |

Comando 8 Zonas - Dimmer



| | |
|---------------------|----------------------------|
| Sinal de saída | RF(2,4GHz) |
| Alimentação | 3VDC (AAA x 2) |
| Duração em Standby | 1 Ano |
| Alcance | >30 Mt |
| Temp. Funcionamento | min. -30 max. +55°C |
| Zonas de Controlo | 8 Zonas |
| Índice de Proteção | IP20 |
| Certificado | CE , RoHS, EMC , LVD , RED |

Obs: Comando touch RGB até 16 Milhões de cores; Inclui 10 Modos Dinâmicos; Tecnologia Wireless 2,4GHz com capacidade até 30 mt.

| Referência | Compatibilidade | Função | Dimensão | Preço |
|------------|-----------------------------------|--------|-------------------|-------|
| SW-RT8 | Todos os controladores da gama SW | Dimmer | 122 x 53 x 17,5mm | |

Comando 8 Zonas - RGB+W



| | |
|---------------------|----------------------------|
| Sinal de saída | RF(2,4GHz) |
| Alimentação | 3VDC (AAA x 2) |
| Duração em Standby | 1 Ano |
| Alcance | >30 Mt |
| Temp. Funcionamento | min. -30 max. +55°C |
| Zonas de Controlo | 8 Zonas |
| Índice de Proteção | IP20 |
| Certificado | CE , RoHS, EMC , LVD , RED |

Obs: Comando touch RGB até 16 Milhões de cores; Inclui 10 Modos Dinâmicos; Tecnologia Wireless 2,4GHz com capacidade até 30 mt.

| Referência | Compatibilidade | Função | Dimensão | Preço |
|------------|-----------------------|--------|-------------------|-------|
| SW-RS8 | SW-VP / SW-V4 / SW-V5 | RGB+W | 141 x 50 x 17,5mm | |



Comando de Parede Superfície RGB-RGB+W / DIMMER



T24B



T20B



T25B



Sinal de saída
Alimentação
Duração em Standby
Alcance

RF(2,4GHz)
3VDC (AAA x 2)
2 Anos
>30 Mt

Temp. Funcionamento
Zonas de Controlo
Índice de Proteção
Certificado

min. -30 max. +55°C
4 Zonas
IP20
CE , RoHS, EMC , LVD , RED

| Referência | Compatibilidade | Função | Dimensão | Preço |
|--------------------|-----------------------------------|---------|---------------|-------|
| SW-T20B SW-T20P | Todos os controladores da gama SW | Dimmer | 122x53x17,5mm | |
| SW-T24B | SW-VP / SW-V4 / SW-V5 | RGB+W | | |
| SW-T25B | SW-V5 / SW-WT5 | RGB+CCT | | |

Comando de Parede Encastre RGB / RGB+W / DIMMER



T14



T15



T16



Sinal de saída
Alimentação
Duração em Standby
Alcance

RF(2,4GHz) + DMX512
100-240V
2 Anos
>30 Mt

Temp. Funcionamento
Zonas de controlo
Certificado
Índice de Proteção

min. -30 max. +55°C
4 Zonas
CE , RoHS, EMC , LVD , RED
IP20

| Referência | Compatibilidade | Função | Dimensão | Preço |
|------------|-----------------------------------|---------|------------------|-------|
| SW-T14 | SW-VP / SW-V4 / SW-V5 | RGB+W | 86 x 86 x 36,5mm | |
| SW-T15 | SW-V5 / SW-WT5 | RGB+CCT | | |
| SW-T16 | Todos os controladores da gama SW | Dimmer | | |

Controlador RGB / RGB+W / CCT / DIMMER 12-24VDC



| | | | |
|----------------------|-------------|---------------------|-------------------------|
| Sinal de Entrada | RF (2,4GHz) | Temp. Funcionamento | min. -30 max. +55°C |
| Nível de Intensidade | 4096 Níveis | Proteção | Polaridade Invertida |
| Gama de intensidade | 0 - 100% | Certificado | CE, RoHS, EMC, LVD, RED |
| Alcance | >30 Mt | Índice de Proteção | IP20 |

| Referência | Alimentação | Saída | Saída Máx. | Push Dim | Função | Dimensão | Preço |
|------------|-------------|---------------|-----------------------------|----------|---------------|-----------------|-------|
| SW-V1 | | 1 Canal x 8A | 12VDC - 96W / 24VDC - 192W | Sim | Dimmer | 97 x 33 x 18mm | |
| SW-V1-L | | 1 Canal x 15A | 12VDC - 180W / 24VDC - 360W | Sim | Dimmer | 160 x 45 x 27mm | |
| SW-WT1 | | 2 Canais x 5A | 12VDC - 120W / 24VDC - 240W | Sim | DIM + CCT | 114 x 38 x 20mm | |
| SW-VP | 12-24VDC | 4 Canais x 4A | 12VDC - 192W / 24VDC - 384W | Não | RGB+W/CCT/DIM | 114 x 38 x 20mm | |
| SW-V4 | | 4 Canais x 5A | 12VDC - 240W / 24VDC - 480W | Sim | RGB+W/CCT/DIM | 160 x 45 x 27mm | |
| SW-V5 | | 5 Canais x 5A | 12VDC - 300W / 24VDC - 600W | Sim | RGB + CCT | 160 x 45 x 27mm | |
| SW-WT5 | | 5 Canais x 3A | 12VDC - 180W / 24VDC - 360W | Não | RGB + CCT | 114 x 38 x 20mm | |

Controlador RGB / Dimmer 230VAC

Funciona S/Neutro

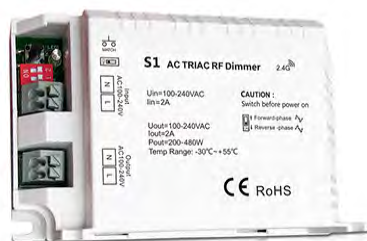

| | | | |
|---------------------|-------------|---------------------|-------------------------|
| Sinal de Entrada | RF (2,4GHz) | Temp. Funcionamento | min. -30 max. +55°C |
| Alcance | >30 Mt | Índice de Proteção | IP20 |
| Gama de intensidade | 0 - 100% | Certificado | CE, RoHS, EMC, LVD, RED |

| Referência | Alimentação | Saída | Saída Máx. | Push Dim | Função | Dimensão | Preço |
|------------|-------------|----------------|---------------|----------|--------|-----------------|-------|
| SW-S1 | | 1 Canal x 2A | 240VAC - 480W | Não | | 103 x 67 x 31mm | |
| SW-S1B | | 1 Canal x 1,5A | 240VAC - 360W | Sim | Dimmer | 52 x 52 x 26mm | |
| SW-S1-F | 100-240VAC | 1 Canal x 1,5A | 240VAC - 360W | Sim | | 52 x 52 x 26mm | |
| SW-S1-HV | | 1 Canal x 1,7A | 240VAC - 360W | Sim | | 52 x 52 x 26mm | |
| SW-S1-BWT | | 1 Canal x 1,5A | 240VAC - 360W | Sim | Dimmer | 52 x 52 x 26mm | |
| SW-S3-WT | | 3 Canal x 1,5A | 240VAC - 720W | Sim | RGB | 160 x 45 x 27mm | |

Controlador ON / OFF 230VAC



tuya



Smart life, smart living



| | | | |
|------------------|----------------|---------------------|---------------------|
| Sinal de Entrada | RF (2,4GHz) | Temp. Funcionamento | min. -30 max. +55°C |
| Alcance | >30 Mt | Índice de Proteção | IP20 |
| Compatibilidade | Comando SW-RU4 | Certificado | CE, RoHS, EMC, LVD |

| Referência | Alimentação | Saída | Saída Máx. | Push Dim | Função | Dimensão | Preço |
|------------|-------------|----------------|------------------------|----------|----------|----------------|-------|
| SW-SS-C | 100-240VAC | 1 Canal x 3A | 100-240VAC / 300W-720W | Sim | ON / OFF | 52 x 52 x 27mm | |
| SW-SS-BWT | 100-240VAC | 1 Canal x 1,5A | 100-240VAC / 150W-360W | Sim | ON / OFF | | tuya |

Controlador Dimmer 0-10V



Smart life, smart living



| | | | |
|------------------|------------------------|---------------------|---------------------|
| Sinal de Entrada | RF (2,4GHz) | Temp. Funcionamento | min. -30 max. +55°C |
| Alcance | >30 Mt | Índice de Proteção | IP20 |
| Compatibilidade | Comando Dimmer gama SW | Certificado | CE, RoHS, EMC, LVD |

| Referência | Alimentação | Saída | Saída Máx. | Push Dim | Função | Dimensão | Preço |
|------------|-------------|----------------|---------------|----------|--------|------------|-------|
| SW-L1 | 85-265VAC | 1 Canal x 1,5A | 240VAC - 360W | Sim | Dimmer | 52x52x27mm | |
| SW-L1WT | 85-265VAC | 1 Canal x 1,5A | 240VAC - 360W | Sim | Dimmer | | tuya |

Controlador Motor Estore TUYA + Comando RF

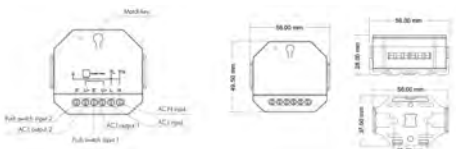

| | |
|---------------------|------------------------|
| Sinal de saída | TUYA App + RF (2,4GHz) |
| Alcance | >30 Mt |
| Temp. Funcionamento | min. -10 max. +55°C |
| Índice de Proteção | 20 |
| Peso | 66g |



| Referência | Potência | Potência Saída | Push Dim | Material | Dimensão | Preço |
|------------|-----------------|----------------------|-----------------|----------|----------------|-------|
| SW-CM-SSWT | 100-240VAC | 480W | Sim | Plástico | 56 x 56 x 35mm | |
| Referência | Compatibilidade | Função | Dimensão | Preço | | |
| SW-RVC | SW-CM-SSWT | Comando para Estores | 139 x 36 x 12mm | | | |

Controlador ZIGBEE 3.0 12/24VDC - 2 / 4 Canais

ZigBee 3.0

Constant voltage LED Controller

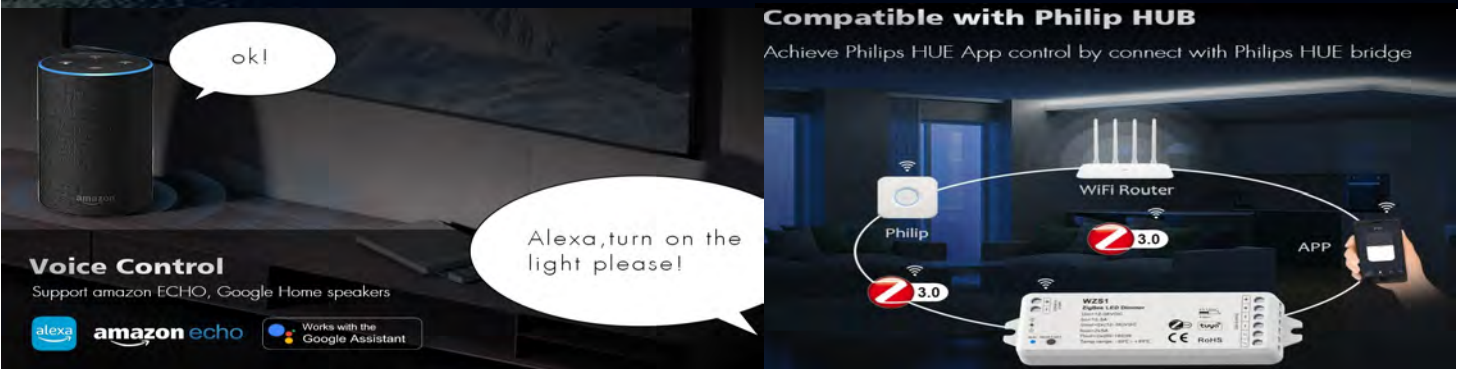
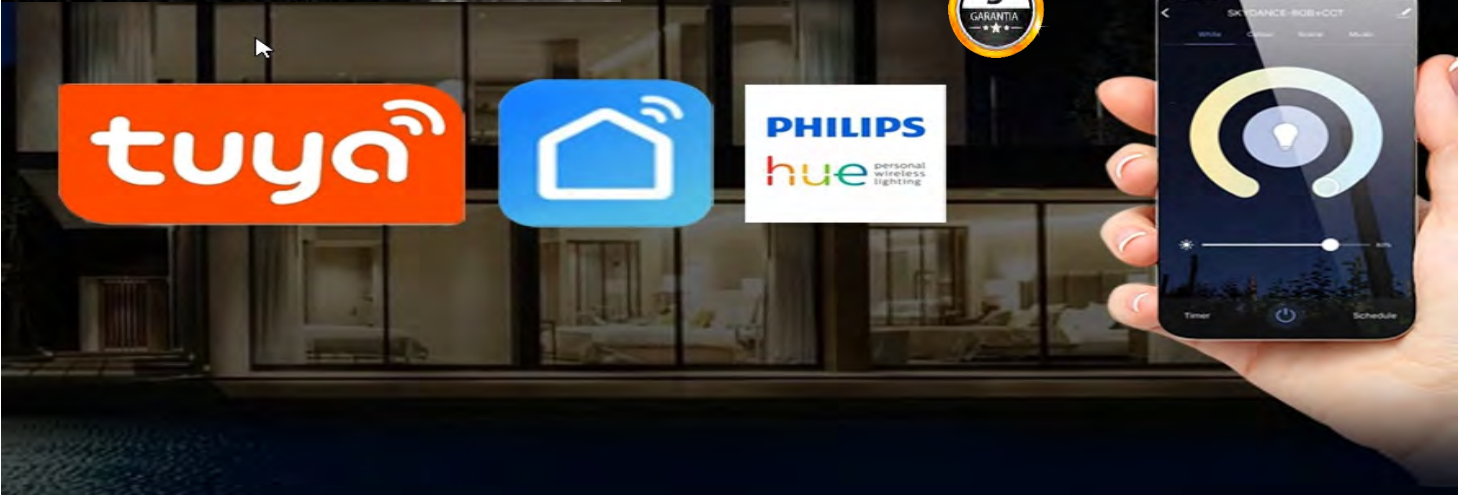

| | | | |
|------------------|-----------------|---------------------|-----------------------|
| Sinal de Entrada | Zigbee 3.0 | Temp. Funcionamento | min. -30 max. +55°C |
| Alcance | >30 Mt | Índice de Proteção | IP20 |
| Compatibilidade | Comando gama SW | Certificado | CE , RoHS , EMC , LVD |

| Referência | Alimentação | Saída | Saída Máx. | Função | Dimensão | Preço |
|------------|-------------|---------------|-----------------------------|---|-----------------|-------|
| SW-WZS1 | 12-24VDC | 2 Canais x 5A | 12VDC - 120W / 24VDC - 240W | Dimmer  | 160 x 45 x 27mm | |
| SW-WZS4 | | 4 Canais x 3A | 12VDC - 144W / 24VDC - 288W | RGB+W  | | |



AC input N AC input L

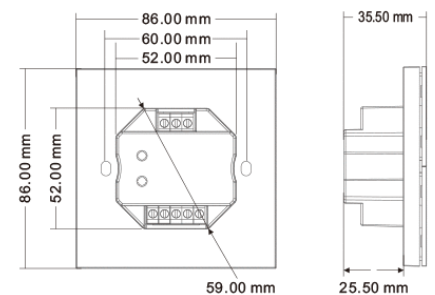
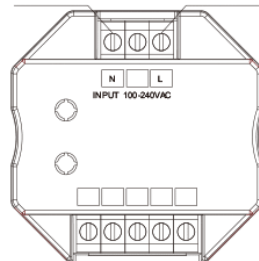

| | | | |
|--------------------|------------|---------------------|-----------------------------|
| Sinal de Saída | Zigbee 3.0 | Temp. Funcionamento | min. -30 max. +55°C |
| Alimentação | 100-240V | Zonas de controlo | 4 Zonas Independentes |
| Duração em Standby | 2 Anos | Certificado | CE , RoHS , EMC , LVD , RED |
| Alcance | >30 Mt | Índice de Proteção | IP20 |

| Referência | Compatibilidade | Função | Dimensão | Preço |
|------------|-----------------|--------------------------------|------------------|-------|
| SW-PK4 | Zigbee 3.0 | Comando remoto para Zigbee 3.0 | 86 x 59 x 25.5mm | |

Controlador DC Dali Dimmer 12/24VDC - 1 / 4 Canais

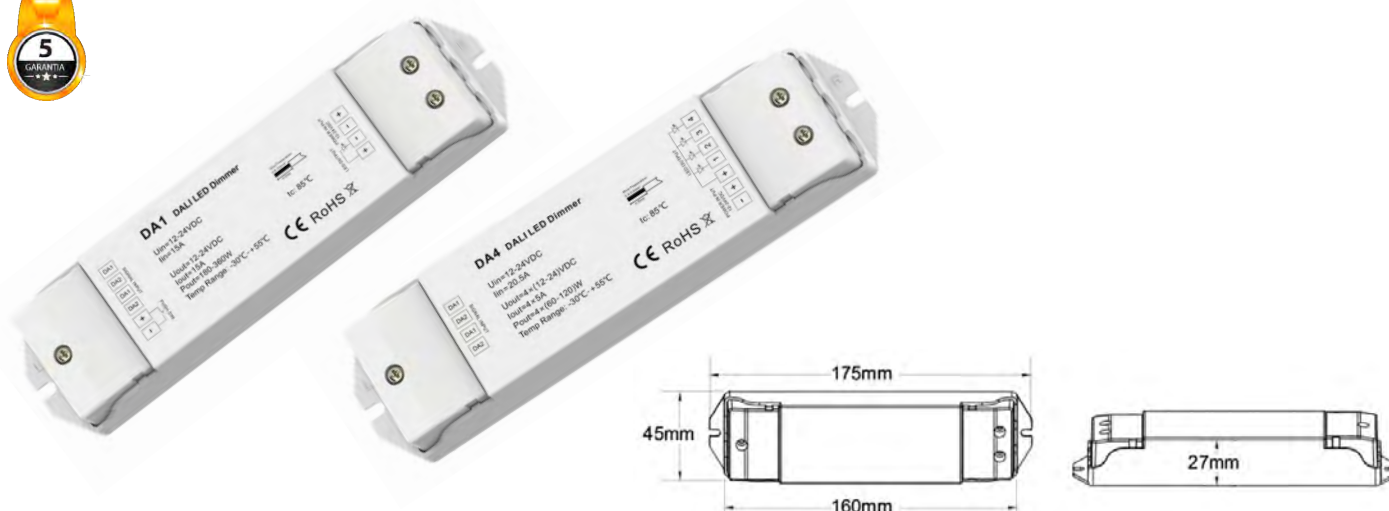

Obs: Endereçamento DALI efetuado automaticamente através do DALI Master

| | | | |
|---------------------|--------------------------|--------------------|----------------------|
| Sinal de Entrada | DALI + PUSH DIM | Proteção | Polaridade Invertida |
| Protocolo | IEC 62386-102, 62386-207 | Certificado | CE, RoHS, EMC, LVD |
| Temp. Funcionamento | min. -30 max. +55°C | Índice de Proteção | IP20 |

| Referência | Alimentação | Saída | Saída Máx. | Função | Dimensão | Preço |
|------------|-------------|---------------|-----------------------------|------------------------------|-----------------|-------|
| SW-DA1 | 12-24VDC | 1 Canal x 15A | 12VDC - 180W / 24VDC - 360W | DALI Dimmer - 1 DALI Address | 160 x 45 x 27mm | |
| SW-DA4 | | 4 Canais x 5A | 12VDC - 240W / 24VDC - 480W | DALI Dimmer - 4 DALI Address | | |

Controlador AC Triac Dali Dimmer 230VAC

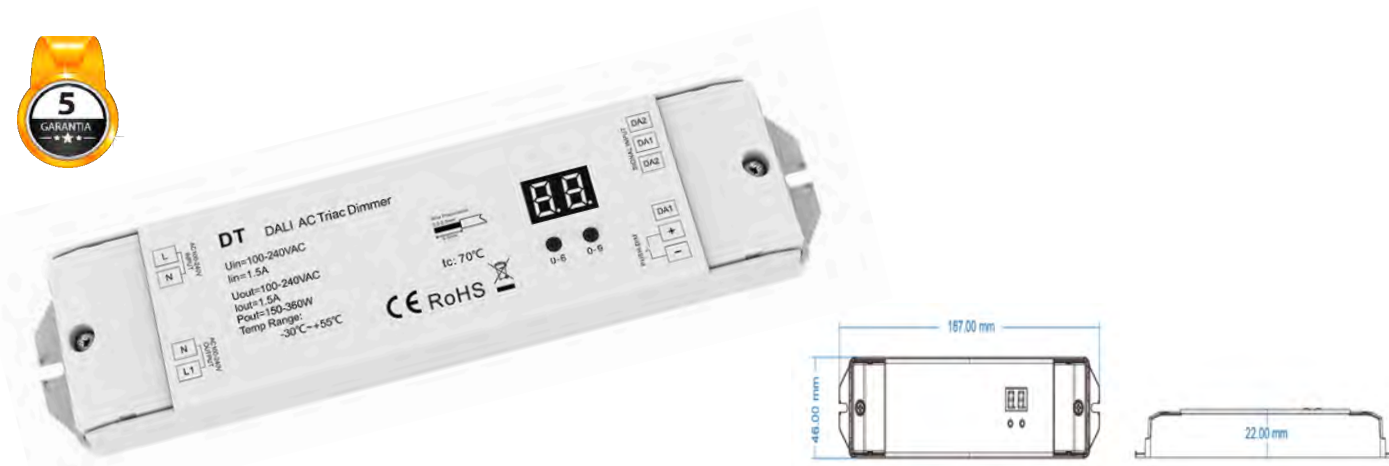

| | | | |
|---------------------|--------------------------|--------------------|----------------------|
| Sinal de Entrada | DALI + PUSH DIM | Proteção | Polaridade Invertida |
| Protocolo | IEC 62386-102, 62386-207 | Certificado | CE, RoHS, EMC, LVD |
| Temp. Funcionamento | min. -30 max. +55°C | Índice de Proteção | IP20 |

Obs: Endereçamento DALI pode ser feito manualmente através do display digital ou automaticamente através do DALI Master

| Referência | Alimentação | Saída | Saída Máx. | Função | Dimensão | Preço |
|------------|-------------|----------------|---------------|------------------------|-----------------|-------|
| SW-DT | 100-240VAC | 1 Canal x 1,5A | 240VAC - 360W | DALI Dimmer - PUSH DIM | 187 x 46 x 22mm | |

Controlador DMX 512 - 3 / 4 / 5 Canais



| | | | |
|---------------------|---------------------|---------------------|-----------------------|
| Função | DIP Switch / RDM | Proteção | Polaridade Invertida |
| Protocolo | DMX512 | Certificado | CE , RoHS , EMC , LVD |
| Temp. Funcionamento | min. -30 max. +55°C | Índice de Protecção | IP20 |

| Referência | Alimentação | Saída | Saída Máx. | Sinal Entrada | Dimensão | Preço |
|------------|-------------|---------------|-----------------------------|------------------------------------|-----------------|-------|
| SW-DMX-3 | | 3 Canais x 8A | 12VDC - 288W / 24VDC - 576W | 3-PinXLR, Terminal Verde DMX | 164 x 65 x 40mm | |
| SW-D3-M | 12-24VDC | | | | 128 x 69 x 39mm | |
| SW-PX-04 | | 4 Canais x 8A | 12VDC - 384W / 24VDC - 768W | RJ45, Terminal Verde DMX | 140 x 50 x 26mm | |
| SW-PX-05 | | 5 Canais x 8A | 12VDC - 480W / 24VDC - 960W | 3-PinXlr, RJ45, Terminal Verde DMX | 125 x 93 x 36mm | |

Controlador DMX 512 - 5 Canais - OLED Display



| | |
|---------------------------|----------------------------------|
| Sinal de Entrada | 3-PinXLR,RJ45,Terminal Verde DMX |
| Protocolo | DMX512 |
| Temp. Funcionamento | min. -30 max. +55°C |
| 25 Prog. RGB Incorporados | Velocidade e Brilho ajustável |
| Protecção | Polaridade Invertida |
| Certificado | CE , RoHS , EMC , LVD |
| Índice de Protecção | IP20 |
| Frequência PWM | 250/ 500/ 2000/ 8000Hz |

| Referência | Alimentação | Saída | Saída Máx. | Função | Dimensão | Preço |
|------------|-------------|---------------|-----------------------------|------------------------------|-----------------|-------|
| SW-D5 | 12-24VDC | 5 Canais x 6A | 12VDC - 360W / 24VDC - 720W | Master & Decoder, Função RDM | 170 x 80 x 40mm | |



| | |
|---------------------|--------------------------|
| Sinal de Entrada | RJ45, Terminal Verde DMX |
| Protocolo | DMX512 |
| Temp. Funcionamento | min. -30 max. +55°C |
| Frequência PWM | 250/ 500/ 2000/ 8000Hz |
| Protecção | Polaridade Invertida |
| Certificado | CE , RoHS , EMC , LVD |
| Índice de Protecção | IP20 |

| Referência | Alimentação | Saída | Saída Máx. | Função | Dimensão | Preço |
|------------|-------------|---------------|-----------------------------|--------------------------|-----------------|-------|
| SW-D5-E | 12-24VDC | 5 Canais x 4A | 12VDC - 240W / 24VDC - 480W | Decoder Mode, Função RDM | 175 x 46 x 32mm | |

27 Controlador LED Digital



KIT SPI / Fita Digital Pixel



| | |
|---------------------|---------------------------|
| Sinal de Saida | RF(2,4GHz) |
| Alimentação | 5-24VDC - Comando(CR2032) |
| Duração em Standby | 1 Ano |
| Control Dots | 50 Pixels Max.3200 |
| Temp. Funcionamento | min. -30 max.+55°C |
| Dimensões | 107 x 58,5 x 9mm |
| Peso | 34g |

Obs: Controlador com sinal de saída SPI para RGB/RGBW; 32 Modos dinâmicos incluídos; Tecnologia Wireless 2,4GHz com capacidade até 30 metros.

| Referência | Potência | Pontos Saida | Sinal Saida | Push Dim | Material | Dimensão | Preço |
|------------|----------|--------------|---------------|----------|----------|----------------|-------|
| SW-SC+R9 | 5-24VDC | 1024 Max | SPI(DATA/CLK) | Não | Plástico | 97 x 33 x 18mm | |

Controlador SPI / Fita Digital Pixel TUYA 5-24VDC



| | |
|---------------------|---------------------------|
| Sinal de Saida | RF(2,4GHz) |
| Alimentação | 5-24VDC - Comando(CR2032) |
| Duração em Standby | 1 Ano |
| Control Dots | 50 Pixels Max.3200 |
| Temp. Funcionamento | min. -30 max.+55°C |
| Dimensões | 107 x 58,5 x 9mm |
| Peso | 34g |

| Referência | Potência | Pontos Saida | Sinal Saida | Push Dim | Material | Dimensão | Preço |
|------------|----------|--------------|-----------------|----------|----------|-----------------|-------|
| SW-WT-SPI | 5-24VDC | 1024 Max | SPI(DATA/CLK)X2 | Não | Plástico | 114 x 38 x 20mm | |

Controlador SPI / Fitas Digital Pixel RGB 5-24VDC



| | |
|---------------------|--------------------|
| Sinal de Saida | RF(2,4GHz) |
| Alcance | >30 Mt |
| Temp. Funcionamento | min. -10 max.+55°C |
| Temporizador | Não suportado |
| Efeitos de Animação | 76 |
| Som | Não suportado |
| IC Suportado | WS2811 / WS2801... |

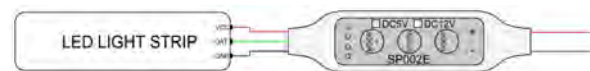

| Referência | Potência | Pontos Saida | Sinal Saida | Push Dim | Material | Dimensão | Preço |
|------------|----------|--------------|-------------|----------|----------|---------------|-------|
| SPO02E | 5-24VDC | 600 Max | SPI | Não | Plástico | 38 x 12 x 5mm | |

Controlador SPI / Fitas Digital Pixel 1 Cor 5-24VDC



| | |
|---------------------|---|
| Sinal de Saída | App + RF(2,4GHz) |
| Alcance | >30 Mt |
| Temp. Funcionamento | min. -10 max.+55°C |
| Temporizador | ON/OFF |
| Efeitos de Animação | ON/OFF |
| Som | Através do Telefone / Micro Incorporado |
| IC Suportado | WS2811 / WS2801... |

| Referência | Potência | Pontos Saída | Sinal Saída | Push Dim | Material | Preço |
|------------|----------|--------------|-------------|----------|----------|-------|
| SP646E | 5-24VDC | 1800 Max | SPI | Não | Plástico | |

Controlador SPI / Fitas Digital Pixel RGB+CCT 5-24VDC



Timers On/Off Mode DIY Effect Music Mode Solid Mode Dynamic Mode



| Referência | Potência | Pontos Saída | Sinal Saída | Push Dim | Material | Dimensão | Preço |
|------------|----------|--------------|-----------------|----------|----------|----------------|-------|
| SP53AE+RB4 | 5-24VDC | 600PX Max | SPI RGB+CCT IoT | Não | Plástico | 78 x 56 x 20mm | |

Controlador SPI / Fitas Digital Pixel 5-24VDC

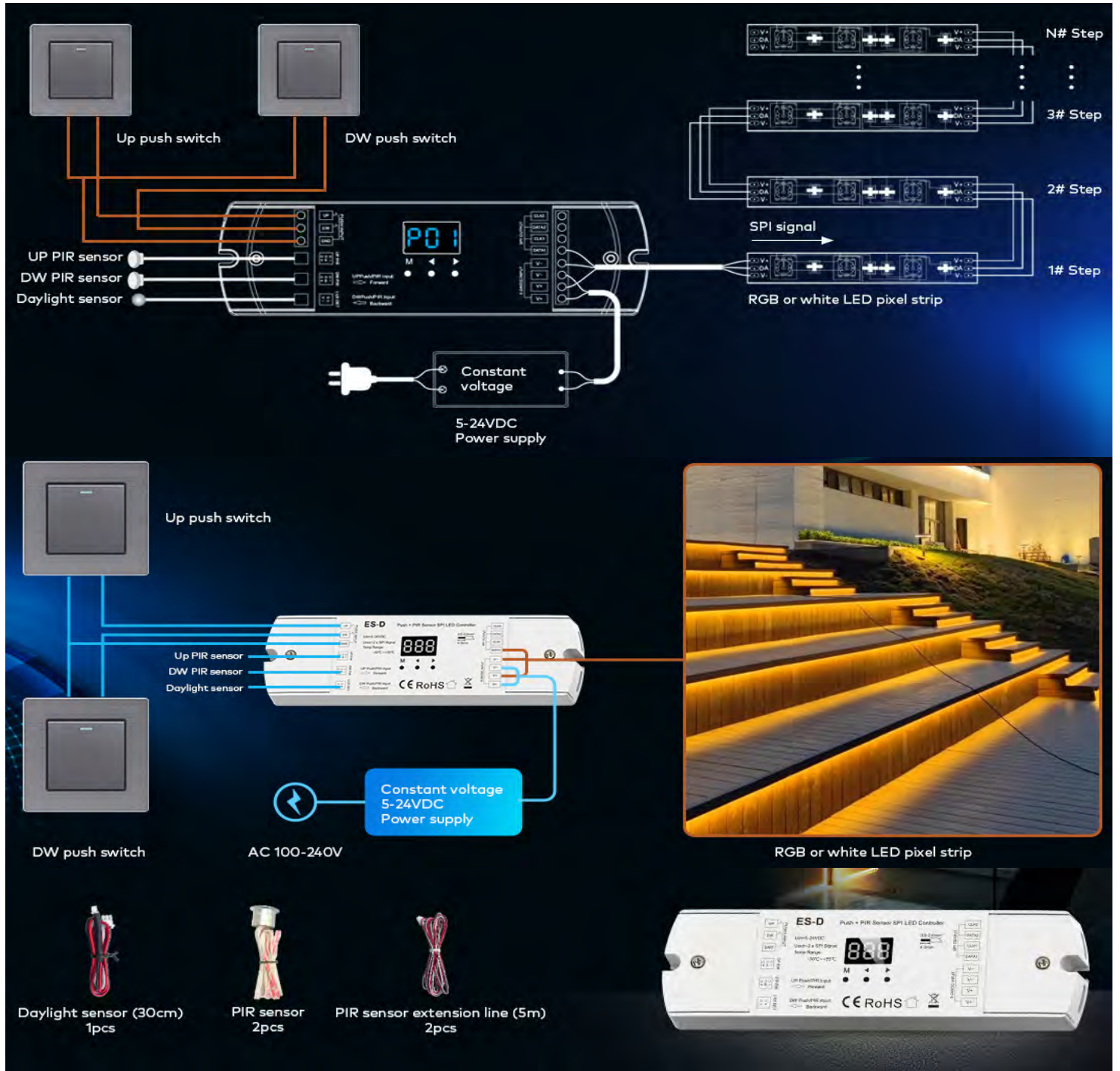

| | | | |
|---------------------|--------------------------|-----------------------|-----------------------|
| Sinal de Entrada | PIR Sensor + Push Button | Proteção | Polaridade Invertida |
| Sinal de Saída | SPI (TTL) X 2 | Certificado | CE , RoHS , EMC , LVD |
| Temp. Funcionamento | min. -30 max. +55°C | Distância de Detecção | 3mt |
| Control Dots | 960 | Ângulo de Detecção | 30° |

| Referência | Alimentação | Saída | Saída Máx. | Push Dim | Dimensão | Preço |
|------------|-------------|---------|-----------------|----------|-----------------|-------|
| SW-ES-D | 5-24VDC | 900 Max | SPI(DATA/CLK)X2 | Sim | 170 x 50 x 23mm | |

Controlador SPI / Fitas Digital Pixel 5-24VDC

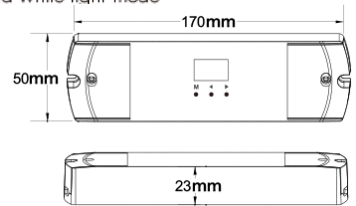
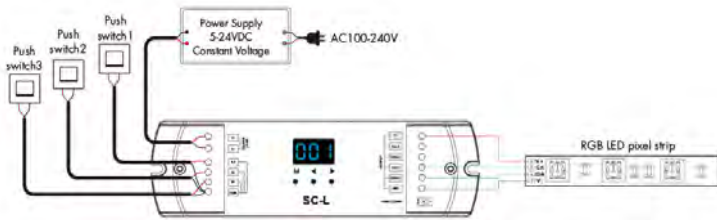
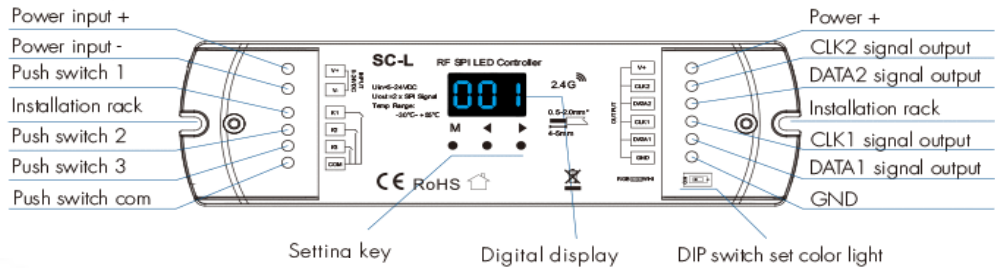
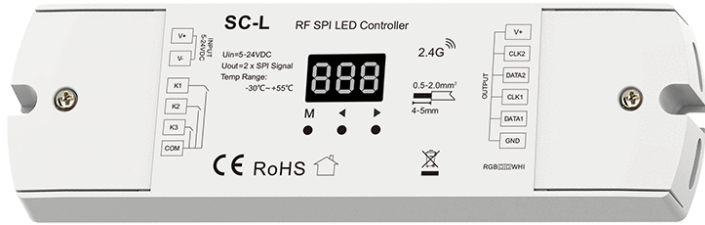

| | | | |
|---------------------|---------------------|--------------------|-----------------------|
| Sinal de Entrada | DMX512 + RF(2,4Ghz) | Proteção | Polaridade Invertida |
| Sinal de Saida | SPI (TTL) X 2 | Certificado | CE , RoHS , EMC , LVD |
| Temp. Funcionamento | min. -30 max.+55°C | Índice de Proteção | IP20 |
| Control Dots | 900 | Dynamic Modes | RGB 32 / Cor única 8 |

| Referência | Alimentação | Saida | Saida Máx. | Push Dim | Dimensão | Preço |
|------------|-------------|---------|-----------------|------------------|-----------------|-------|
| SW-SC-L | 5-24VDC | 900 Max | SPI(DATA/CLK)X2 | Sim (3 switches) | 170 x 50 x 23mm | |

Controlador DMX - SPI 5-24VDC

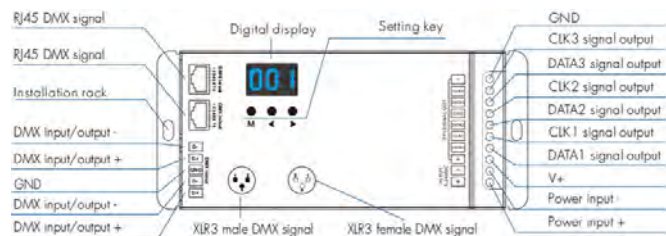

| | | | |
|---------------------|-----------------------------|--------------------|-----------------------|
| Sinal de Entrada | DMX512 + RF(2,4Ghz) | Proteção | Polaridade Invertida |
| Sinal de Saida | SPI (TTL) X 3 | Certificado | CE , RoHS , EMC , LVD |
| Temp. Funcionamento | min. -30 max.+55°C | Índice de Proteção | IP20 |
| Control Dots | 170Pixels (RGB510CH)Max.900 | Dynamic Modes | 32 |

| Referência | Alimentação | Saida | Saida Máx. | Função | Dimensão | Preço |
|------------|-------------|----------------|---------------|--------------|-----------------|-------|
| SW-DSA | 100-240VAC | 1 Canal x 1,5A | 240VAC - 360W | DMX512 - SPI | 187 x 46 x 22mm | |

28

Dimmers



Dimmer 12V



Obs: Ideal para trabalhar com baixa potência, RF de bom alcance, comando tipo porta chaves.

| Referência | Potência | Volts | Canais | Sinal de Entrada | Material | Dimensão | Preço |
|------------|-------------|-------|--------|------------------|----------|----------------|-------|
| 521/CH | 12VDC / 96W | 12VDC | 1 | RF (2,4GHz) | Plastico | 98 x 57 x 34mm | |

Dimmer 12-24V



Obs: Comando com 4 Canais, ideal para controlo de iluminação led 5/24VDC; comando pode controlar até 4 zonas diferentes.

Nota: Kit de 1 controlador + Comando.

| Referência | Potência | Volts | Canais | Sinal de Entrada | Material | Dimensão | Preço |
|------------|--------------|-----------|--------|------------------|------------------|-----------------|-------|
| 670 | 12VDC / 192W | 5- 24 VDC | 1 | RF (2,4GHz) | Metal / Plastico | 120 x 67 x 27mm | |

Comando Dimmer SR



Obs: Comando 1 canal Touch. Acabamento suave e ergonómico. Compatível com os dimmers SR-2501.

Nota: Contém suporte de parede para comando. Pilhas incluídas.

| Referência | Zonas | Compatibilidade | Função | Sinal Saída | Alimentação | Dimensão | Preço |
|------------|-------|---------------------|--------|-------------|------------------|------------------|-------|
| SR-2828 | 1 | Toda a Gama SR-2501 | Dimmer | RF (2,4GHz) | 2 x Pilha CR2025 | 141 x 35 x 8,5mm | |



Obs: Comando 1 canal. Acabamento suave e ergonómico. Compatível com os dimmers SR-2501.

Nota: Contém suporte de parede para comando. Pilhas incluídas.

| Referência | Zonas | Compatibilidade | Função | Sinal Saída | Alimentação | Dimensão | Preço |
|------------|-------|-------------------------------|--------|-------------|------------------|--------------|-------|
| SR-2807N | 1 | Toda a Gama SR-2501 | DIMMER | RF (2,4GHz) | 1 x Pilha CR2025 | Ø38,5 x 14mm | |
| SR-2833S | | SR-1009SAC-HP / SR-2400TAC-RF | | | | | |

Dimmer SR 12-24V



Obs: Permite dimar equipamentos de 12VDC, através de controle 0/1-10V.
Nota: Compatível com TX211A (Hager); MTN647091 (SCHNEIDER).

| Referência | Potência | Volts (ent/saída) | Canais | Sinal Entrada | Push Dim | Função | Dimensão | Preço |
|------------|---------------|-------------------|--------|---------------|----------|--------|----------------|-------|
| SR-2006 | 12VDC / 1*96W | 12- 36 VDC | 1 | 0/1-10V | NÃO | Dimmer | 95 x 37 x 20mm | |

Dimmer 230VAC



Obs: Permite control através botão pressão (push) ou com comando RF. (SR-2801F e SR-2828).

Nota: Controlador dimmer Push / Comando RF.

| Referência | Potência | Volts (ent/saída) | Canais | Sinal Entrada | Push Dim | Função | Dimensão | Preço |
|------------|----------|-------------------|--------|------------------|----------|--------|-----------------|-------|
| SR-2501AC | 2x 200W | 210 - 240 VAC | 1 | Rádio Frequência | SIM | Dimmer | 170 x 59 x 29mm | |



Obs: Tamanho standard EU. Permite controle com comando SR-2833S.



| Referência | Potência | Volts (ent/saída) | Canais | Sinal Entrada | Push Dim | Função | Dimensão | Preço |
|---------------|----------|-------------------|--------|-----------------|----------|--------|----------------|-------|
| SR-2400TAC-RF | 150W | 100-240VAC | 1 | Dimmer RF TRIAC | | Dimmer | 80 x 80 x 53mm | |

Dimmer WIFI TRIAC 230VAC



Funciona S/Neutro

- Neutral not required
- OT, OC, ST protection
- Min. Min. Brightness adjustable
- Max. brightness self-adjust
- Power-cut memory and turn-off memory
- Com Compatible with RC and RL
- Multiway Multiway control

| Referência | Potência | Volts (ent/saída) | Canais | Sinal Entrada | Push Dim | Função | Dimensão | Preço |
|------------|----------|-------------------|--------|---------------|----------|--------|----------------|-------|
| VK-D688 | 150W | 100-240VAC | 1 | Dimmer TRIAC | | Dimmer | 80 x 80 x 53mm | |
| VK-SP | Espelho | | | | | | | |



29

Kinetic Switch



 Sem fios

 Sem Bateria

 Confiável

 3 Anos de Garantia

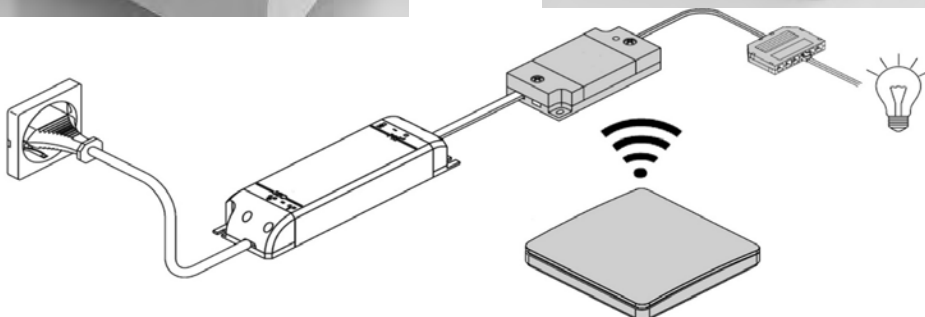

Controlador Kinetic

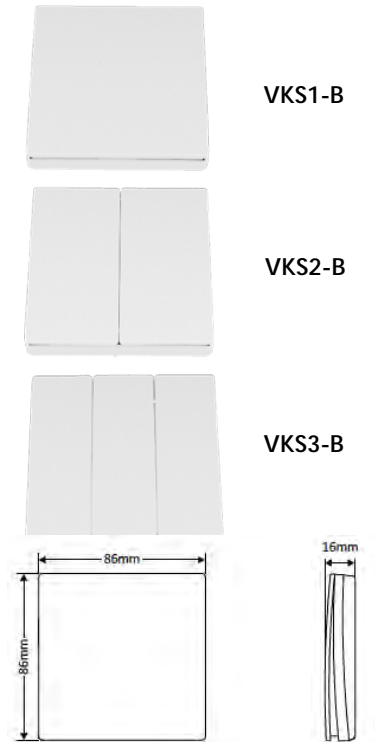

| Referência | RF | Compatibilidade | Função | Material | IP | Preço |
|------------|--------|-----------------|-------------------|---------------|----|-------|
| VKS1-B | | | | | | |
| VKS2-B | 433Mhz | Recetor Kinetic | On / Off - Dimmer | Policarbonato | 65 | |
| VKS3-B | | | | | | |

Kinetic Recetor WIFI 230VAC

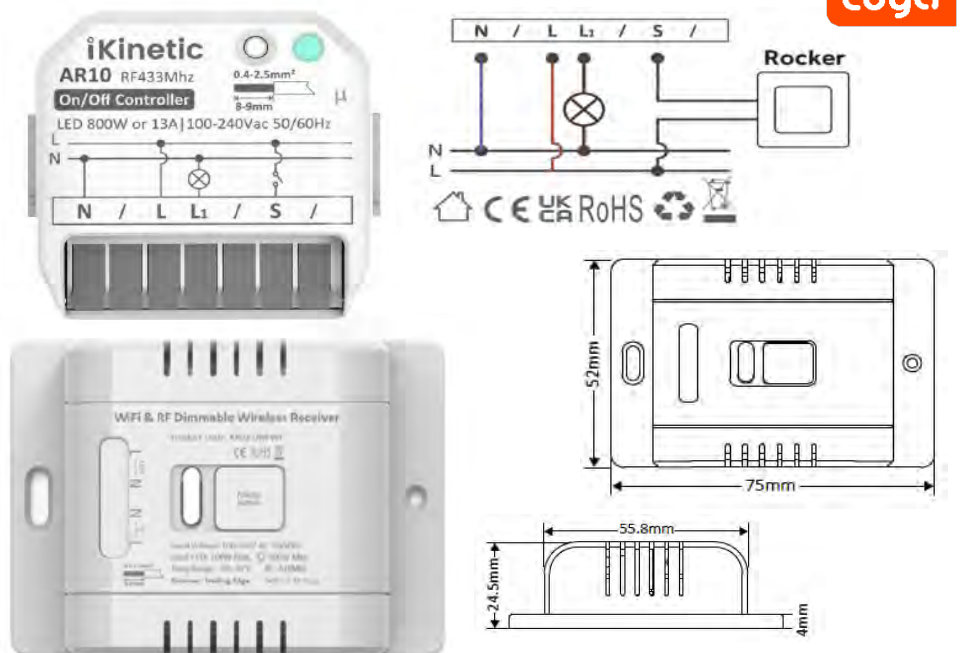

| | | | |
|------------------|-------------------------|---------------------|---------------------|
| Sinal de Entrada | RF 433Mhz + Tuya App | Temp. Funcionamento | min. -30 max. +55°C |
| Alcance | >30 Mt | Índice de Proteção | IP20 |
| Compatibilidade | Comandos Kinetic Switch | Certificado | CE , RoHS |

| Referência | Alimentação | Saída Máx. | Função |
|------------|-------------|------------|--------|
| VKR10-B | | 800W | On/Off |
| VKR2-B | 85-240V | 100W | Dimmer |

Kinetic Recetor WIFI 12 / 24VDC



| | | | |
|------------------|---------------------------------|---------------------|--------------------|
| Sinal de Entrada | RF 433Mhz + Tuya App | Temp. Funcionamento | min. -10 max.+40°C |
| Alcance | >35 Mt Exterior; >15Mt Interior | Índice de Proteção | IP44 |
| Material | Polycarbonato | Certificado | CE , RoHS |

| Referência | Alimentação | Saída Máx. | Função | Preço |
|------------|-------------|----------------------------|--------|-------|
| VKR3-B | 12-24VDC | 12VDC - 60W / 24VDC - 120W | Dimmer | |

Kinetic Campainha

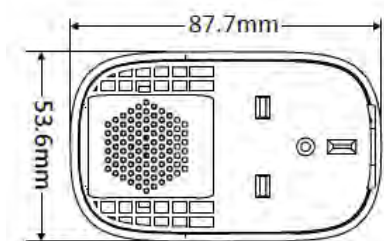
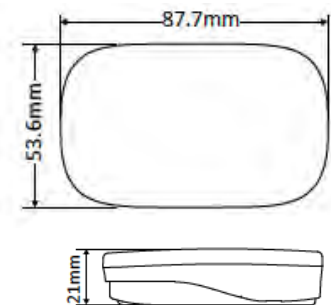

| | | | |
|------------------|---------------------------------|---------------------|--------------------|
| Sinal de Entrada | RF 433Mhz | Temp. Funcionamento | min. -10 max.+40°C |
| Alcance | >35 Mt Exterior; >15Mt Interior | Índice de Proteção | IP44 |
| Material | Polycarbonato | Certificado | CE , RoHS |

| Referência | Alimentação | Função | Preço |
|------------|-------------|--------------------|-------|
| VDB1-B | 85-240V | Campainha Cinética | |

Kinetic Recetor Matter 230VAC ON/OFF

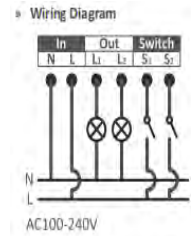
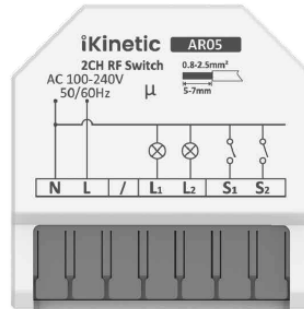
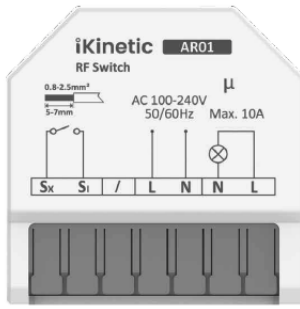

| | | | |
|------------------|---------------------------------|---------------------|--------------------|
| Sinal de Entrada | RF433Mhz+Matter+Contato Seco | Temp. Funcionamento | min. -10 max.+40°C |
| Alcance | >35 Mt Exterior; >15Mt Interior | Índice de Proteção | IP20 |
| Material | Policarbonato | Certificado | CE , RoHS |

| Referência | Alimentação | Saida Máx. | Função | Dimensões |
|------------|-------------|------------|--------|------------------|
| AR01-MW | 85-240V | 4A | On/Off | 67 x 33 x 24mm |
| AR05-MW | | 2x3A | On/Off | 42 x 42 x 16.5mm |

Kinetic Recetor Matter 230VAC Dimmer

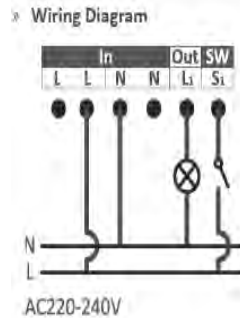
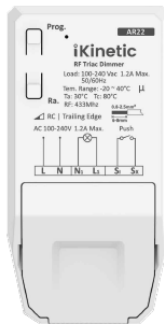

| | | | |
|------------------|---------------------------------|---------------------|--------------------|
| Sinal de Entrada | RF 433Mhz +Matter + Push Dim | Temp. Funcionamento | min. -10 max.+40°C |
| Alcance | >35 Mt Exterior; >15Mt Interior | Índice de Proteção | IP20 |
| Material | Policarbonato | Certificado | CE , RoHS |

| Referência | Alimentação | Saida Máx. | Função | Dimensões | Preço |
|------------|-------------|------------|--------|----------------|-------|
| AR22-MW | 85-240V | 300W | Dimmer | 88 x 45 x 24mm | |

Kinetic Recetor Matter 12-24VDC Dimmer

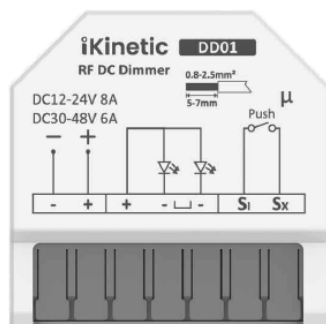

| | | | |
|------------------|---------------------------------|---------------------|--------------------|
| Sinal de Entrada | RF 433Mhz +Matter + Push Dim | Temp. Funcionamento | min. -10 max.+40°C |
| Alcance | >35 Mt Exterior; >15Mt Interior | Índice de Proteção | IP20 |
| Material | Policarbonato | Certificado | CE , RoHS |

| Referência | Alimentação | Saida Máx. | Função | Dimensões | Preço |
|------------|----------------|----------------------------|--------|----------------|-------|
| DD01-MW | 12-24VDC | 12VDC - 96W / 24VDC - 192W | Dimmer | 53 x 53 x 24mm | |
| BR01 | Pilha - CR2032 | | | 88 x 74 x 15mm | |



Amplificador SW RGBW



| | | | |
|---------------------|--------------------|--------------------|-----------------------------|
| Sinal de Entrada | PWM e DMX Decoders | Certificado | CE , RoHS , EMC , LVD , RED |
| Temp. Funcionamento | min. -30 max.+55°C | Índice de Proteção | IP20 |

| Referência | Alimentação | Saída | Saída Máx. | Função | Dimensão | Preço |
|------------|-------------|---------------|-----------------------------|-----------------------|-------------------|-------|
| SW-EV1-S | | 1 Canal x 15A | 12VDC - 180W / 24VDC - 360W | | 160 x 45 x 27mm | |
| SW-EV4 | 12-24VDC | 4 Canais x 5A | 12VDC - 240W / 24VDC - 480W | Amplificador de Sinal | 175 x 45 x 27mm | |
| SW-EV5 | | 5 Canais x 5A | 12VDC - 240W / 24VDC - 720W | | 107 x 75 x 24.5mm | |

Amplificador SR RGBW

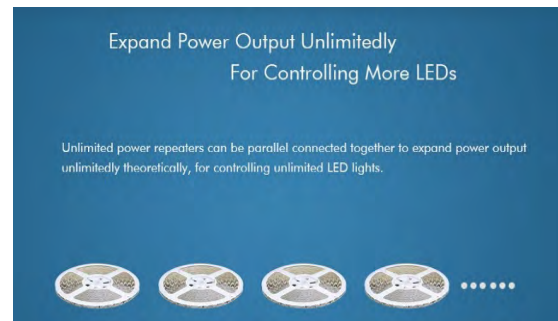

| | | | |
|---------------------|--------------------|--------------------|-----------------------------|
| Sinal de Entrada | PWM e DMX Decoders | Certificado | CE , RoHS , EMC , LVD , TUV |
| Temp. Funcionamento | min. -20 max.+50°C | Índice de Proteção | IP20 |

| Referência | Alimentação | Saída | Saída Máx. | Função | Dimensão | Preço |
|------------|---------------|---------------|-----------------------------|-------------------------------|-----------------|-------|
| SR-3002 | 12VDC / 4*96W | 4 Canais x 8A | 12VDC - 384W / 24VDC - 768W | PWM (0/1-10V e DMX Decoders) | 168 x 58 x 28mm | |

Amplificador RGB / RGBW



| Referência | Alimentação | Saída | Saída Máx. | Função | Dimensão | Preço |
|------------|-------------|---------------|-----------------------------|-----------------------|-----------------|-------|
| 529/SM | 12-24VDC | 3 Canais x 5A | 12VDC - 180W / 24VDC - 360W | Amplificador de Sinal | 60 x 34 x 74mm | |
| 529W | | 4 Canais x 5A | 12VDC - 240W / 24VDC - 480W | | 147 x 74 x 34mm | |

Amplificador RGB

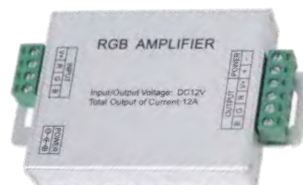

| Referência | Alimentação | Saída | Saída Máx. | Função | Dimensão | Preço |
|------------|-------------|---------------|-----------------------------|-----------------------|-----------------|-------|
| 324 | 12-24VDC | 3 Canais x 4A | 12VDC - 144W / 24VDC - 288W | Amplificador de Sinal | 140 x 65 x 24mm | |

31

Sensores



Sensor Movimento PIR

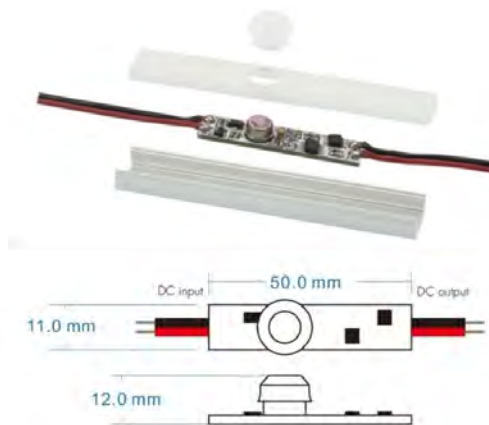

Obs: ON - Quando pessoas ou objectos entram no seu raio de ação.
OFF - Quando os mesmos se afastam e após 30s.
 Normalmente instalado em perfil de alumínio.

| | | | |
|---------------------|---------------------|--------------------|----------------------|
| Alcance | Até 3 Mt | Proteção | Polaridade Invertida |
| Ângulo de Detecção | 120 | Certificado | CE , EMC , LVD |
| Temp. Funcionamento | min. -30 max. +55°C | Índice de Proteção | IP20 |

| Referência | Alimentação | Saída | Saída Máx. | Função | Dimensão | Preço |
|------------|-------------|--------------|---------------------------|--------------------------|----------------|-------|
| SW-E1-R | 12-24VDC | 1 Canal x 3A | 12VDC - 36W / 24VDC - 72W | PIR Motion Sensor Switch | 50 x 11 x 12mm | |

Touch Dimmer 12/24V



Obs: Para perfil, controlado através da tampa. Com um só toque desliga, se mantiver pressionado aumenta ou diminui a intensidade.

Nota: Led azul de indenificação StandBy.

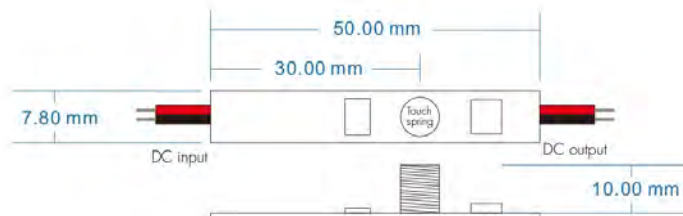

| Referência | Alimentação | Saída | Saída Máx. | Função | Dimensão | Preço |
|------------|-------------|--------------|---------------------------|------------------------|-----------------|-------|
| SW-E1-C | 12-24VDC | 1 Canal x 3A | 12VDC - 36W / 24VDC - 72W | Touch Dimmer p/ perfil | 50 x 7,8 x 10mm | |

Sensor para Porta de Roupeiro

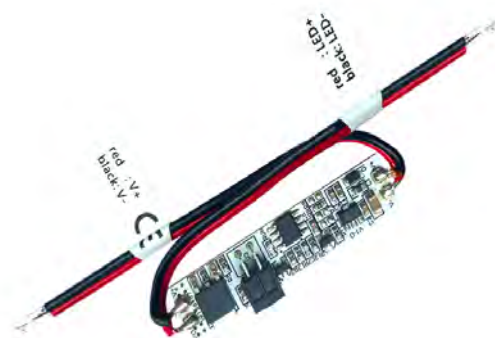

Obs: Para instalação em perfil de led. Abrindo a porta liga gradualmente, ao fechar a porta desliga gradualmente.

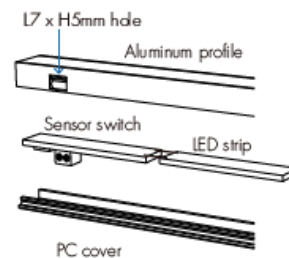
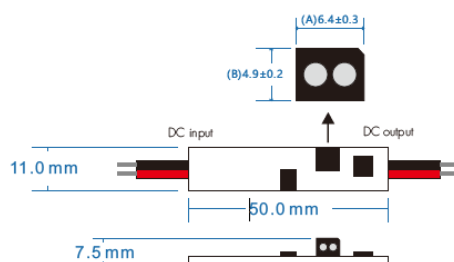

| | | | |
|--------------------|----------|-------------|----------------------|
| Alcance | Até 8 Cm | Proteção | Polaridade Invertida |
| Ângulo de Detecção | 15-30cm | Certificado | CE , EMC , LVD |

| Referência | Alimentação | Saída | Saída Máx. | Função | Dimensão | Preço |
|------------|-------------|--------------|---------------------------|-------------------|-----------------|-------|
| SW-E1-D | 12-24VDC | 1 Canal x 3A | 12VDC - 48W / 24VDC - 96W | Sensor P/Roupeiro | 50 x 7,8 x 10mm | |

Sensor PIR Encastrar



Sensor PIR de montagem em teto falso
 Saída de 1 Canal com possibilidade dimmer 0/1-10V
 Funciona com comando remoto RF 2.4G da Gama SW
 Vários modos de funcionamento
 Tempo / LUX /
 Funciona como comando remoto RF.
 Envia sinal RF 2,4G e emparelha com Controladores da Gama SW

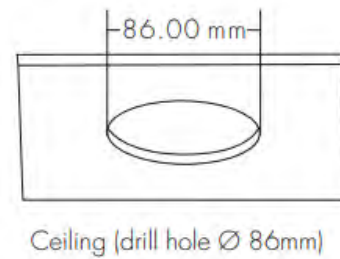
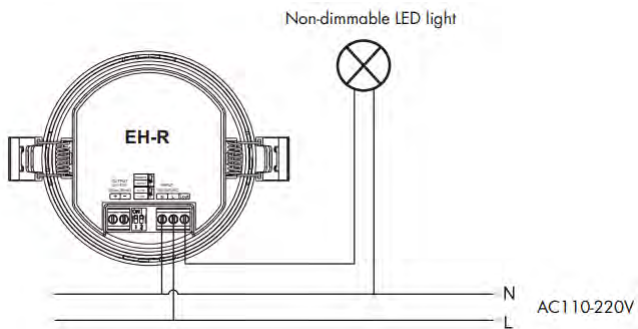
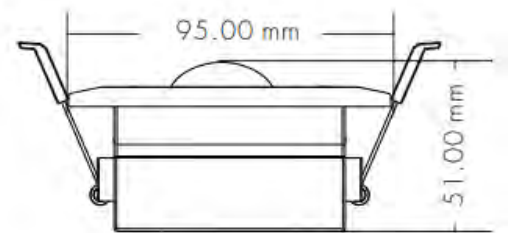
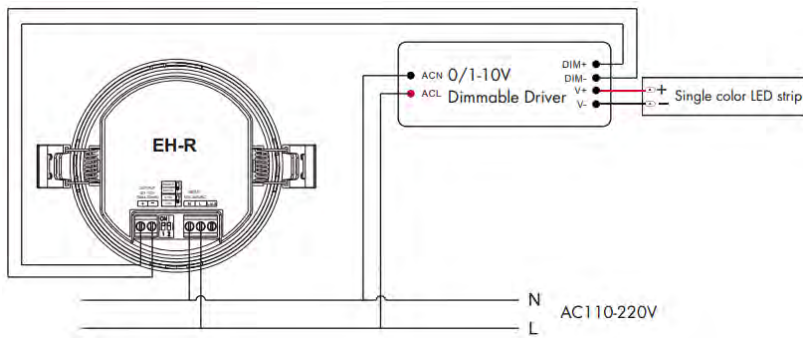

| | | | |
|---------------------|---------------------|--------------------|----------------------|
| Alcance | Até 5Mt | Proteção | Polaridade Invertida |
| Ângulo de Detecção | 120 | Certificado | CE, EMC, LVD |
| Temp. Funcionamento | min. -30 max. +55°C | Índice de Proteção | IP20 |

| Referência | Alimentação | Saída | Saída Máx. | Função | Dimensão | Preço |
|------------|-------------|-------|-----------------------------|------------------------------|----------|-------|
| SW-EH-R | 100-240VAC | 4A | 12VDC - 384W / 24VDC - 768W | Constant Voltage + SPI (TTL) | 86mm | |

Kit Sensor Movimento PIR 12/24V

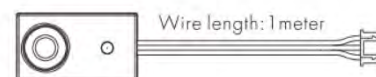
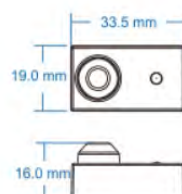
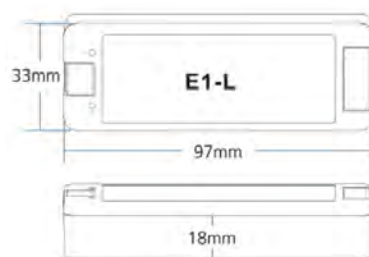

Obs: Sensor de pequenas dimensões.

ON - Quando pessoas ou objectos entram no seu raio de ação.

OFF - Quando os mesmos se afastam e após 30s.

| | | | |
|--------------------|----------|-------------|----------------------|
| Alcance | Até 3 Mt | Proteção | Polaridade Invertida |
| Ângulo de Detecção | 120 | Certificado | CE , EMC , LVD |

| Referência | Alimentação | Saída | Saída Máx. | Função | Dimensão | Preço |
|------------|-------------|--------------|----------------------------|----------------------|----------------|-------|
| SW-E1L-ER | 12-24VDC | 1 Canal x 8A | 12VDC - 96W / 24VDC - 198W | Sensor Movimento PIR | 97 x 33 x 18mm | |

Kit Sensor Movimento PIR 230VAC

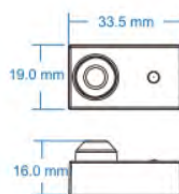
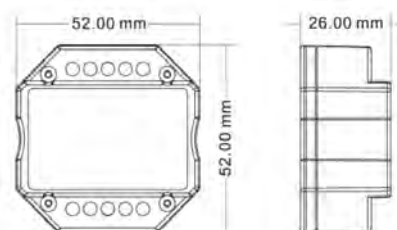

Obs: Sensor de pequenas dimensões.

ON - Quando pessoas ou objectos entram no seu raio de ação.

OFF - Quando os mesmos se afastam e após 30s.

| | | | |
|--------------------|----------|-------------|----------------------|
| Alcance | Até 3 Mt | Proteção | Polaridade Invertida |
| Ângulo de Detecção | 120 | Certificado | CE , EMC , LVD |

| Referência | Alimentação | Saída | Saída Máx. | Função | Dimensão | Preço |
|------------|-------------|--------------|---------------|----------------------|----------------|-------|
| SW-E1H-ER | 100-240VAC | 1 Canal x 3A | 240VAC - 720W | Sensor Movimento PIR | 52 x 52 x 26mm | |

Sensores DIY



Sensor DIY 12/24VDC

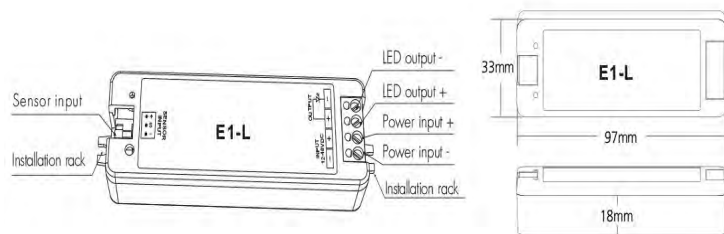

Índice de Proteção
Temp. Funcionamento

IP20
min. -30 max. +55°C

Proteção
Certificado

Polaridade Invertida
CE , EMC , LVD

| Referência | Alimentação | Saída | Saída Máx. | Função | Dimensão | Preço |
|------------|-------------|--------------|----------------------------|-----------------------------|----------------|-------|
| SW-E1L | 12-24VDC | 1 Canal x 8A | 12VDC - 96W / 24VDC - 198W | Controlador para Sensor DIY | 97 x 33 x 18mm | |

Sensor DIY 230AC

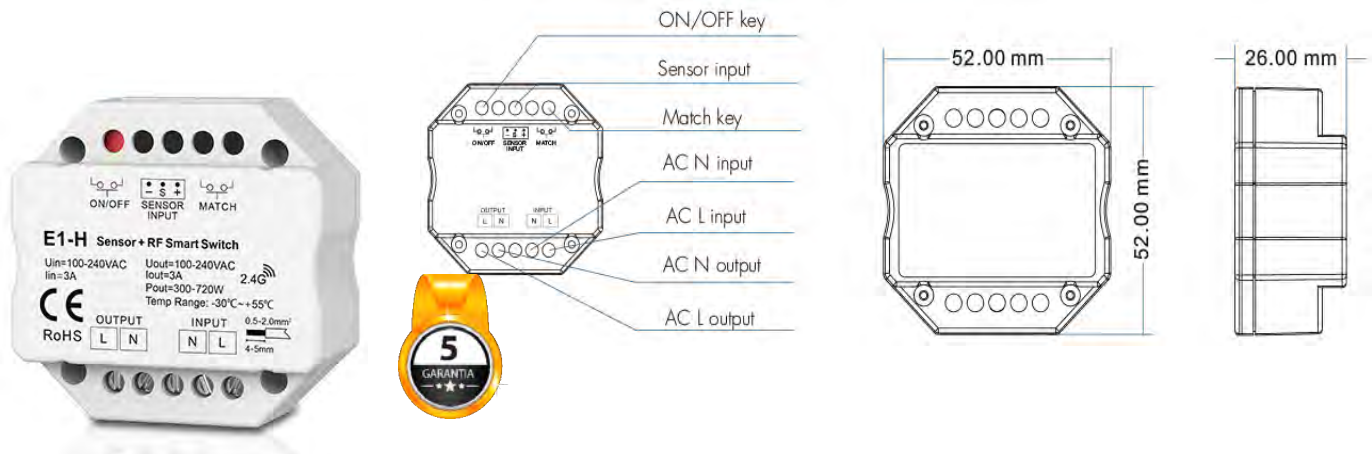

Índice de Proteção
Temp. Funcionamento

IP20
min. -30 max. +55°C

Proteção
Certificado

Polaridade Invertida
CE , EMC , LVD

| Referência | Alimentação | Saída | Saída Máx. | Função | Dimensão | Preço |
|------------|-------------|--------------|---------------|-----------------------------|----------------|-------|
| SW-E1H | 100-240VAC | 1 Canal x 3A | 240VAC - 720W | Controlador para Sensor DIY | 52 x 52 x 26mm | |

Sensor DIY Microondas

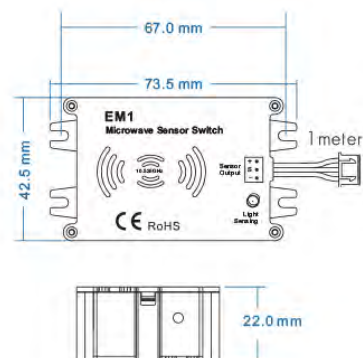

| | | | |
|----------------------|---------------------------------|------------------------------|--------------------------------|
| Alcance | Max.(DxH) 20 x 15Mt | Sensibilidade de Detecção | 10%, 25%, 50%, 75%, 100% |
| Ângulo de Detecção | instalação Parede 150°/Teto 360 | Sensibilidade Luminosa (Lux) | 10, 30, 50, 100, 150, 200, Off |
| Altura de Instalação | Max.15Mt | Detecção de Movimento | 0,5 - 3m/s |

| Referência | Função | Dimensão | Preço |
|------------|-------------------|------------------|-------|
| SW-EM1 | Sensor Microondas | 67 x 42,5 x 22mm | |

Sensor DIY para Porta de Roupeiro

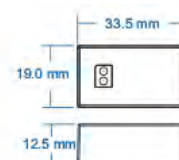
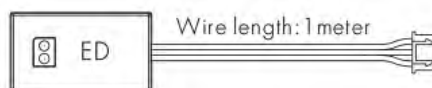

| | | | |
|--------------------|-----------|-------------|----------------------|
| Alcance | Até 10 Cm | Proteção | Polaridade Invertida |
| Ângulo de Detecção | 15 - 30° | Certificado | CE , EMC , LVD |

| Referência | Função | Dimensão | Preço |
|------------|-----------------------|--------------------|-------|
| SW-ED | Sensor Porta Roupeiro | 33,5 x 19 x 12,5mm | |

Sensor DIY Passagem

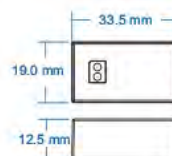

| | | | |
|--------------------|----------|-----------------|----------------|
| Alcance | Até 8 Cm | Cabo de Ligação | 1 Mt |
| Ângulo de Detecção | 15 - 30° | Certificado | CE , EMC , LVD |

| Referência | Função | Dimensão | Preço |
|------------|-----------------|----------------|-------|
| SW-EB | Sensor Passagem | 33,5x19x12,5mm | |

Sensor PIR de escadas - 32 Canais - OLED



Facilidade de uso com ecrã Oled e 3 botões
 4 modos de funcionamento seleccionáveis
 2 Sensores de Movimento
 Múltiplos modos de cor incorporados
 Velocidade 1-8 ajustável
 Função de auto-teste



Daylight sensor (30cm)
1 pcs



PIR sensor
2 pcs



PIR sensor
extension line (5m)
2 pcs

Alcance Até 3 Mt
 Ângulo de Detecção 120
 Temp. Funcionamento min. -30 max. +55°C

Proteção
 Certificado
 Índice de Proteção

Polaridade Invertida
 CE, EMC, LVD
 IP20

| Referência | Alimentação | Saída | Saída Máx. | Função | Dimensão | Preço |
|------------|-------------|----------------|-----------------------------|------------------------------|-----------------|-------|
| SW-ES32 | 12-24VDC | 32 Canais x 1A | 12VDC - 384W / 24VDC - 768W | Constant Voltage + SPI (TTL) | 170 x 80 x 40mm | |

Interruptor / Dimmer 12/24VDC



Índice de Proteção IP20
 Temp. Funcionamento min. -30 max. +55°C

Proteção
 Certificado

Polaridade Invertida
 CE, EMC, LVD, RED

| Referência | Alimentação | Saída | Saída Max. | Função | Dimensão | Preço |
|------------|-------------|--------------|----------------------------|-----------------------------|----------------|-------|
| SR-TOD | 12-24VDC | 1 Canal x 8A | 12VDC - 96W / 24VDC - 198W | Controlador para Sensor DIY | 52 x 52 x 26mm | |

Sensor 1 Porta ON/OFF 12/24VDC



| | |
|---------------------|--------------------|
| Índice de Proteção | IP20 |
| Temp. Funcionamento | min. -30 max.+55°C |
| Cabo | 2 Mt |
| Cor | Preto |

| Referência | Alimentação | Saída | Saída Max. | Função | Dimensão | Preço |
|------------|-------------|----------|------------|--------------|--------------------------|-------|
| SR-DC01 | 12-24VDC | 12-24VDC | 60W | Sensor Porta | Corte 12mm / Altura 18mm | |

Sensor 2 Portas ON/OFF 12/24VDC



| | |
|---------------------|--------------------|
| Índice de Proteção | IP20 |
| Temp. Funcionamento | min. -30 max.+55°C |
| Cabo | 2 Mt |
| Cor | Preto |

| Referência | Alimentação | Saída | Saída Max. | Função | Dimensão | Preço |
|------------|-------------|----------|------------|--------------|--------------------------|-------|
| SR-DC02 | 12-24VDC | 12-24VDC | 60W | Sensor Porta | Corte 12mm / Altura 18mm | |

Interruptor / Dimmer Touch 12/24VDC



| | |
|---------------------|--------------------|
| Índice de Proteção | IP20 |
| Temp. Funcionamento | min. -30 max.+55°C |
| Cabo | 2 Mt |
| Cor | Preto |

| Referência | Alimentação | Saída | Saída Max. | Função | Dimensão | Preço |
|------------|-------------|----------|------------|--------------|--------------------------|-------|
| SR-TC01 | 12-24VDC | 12-24VDC | 60W | Dimmer/Touch | Corte 12mm / Altura 18mm | |

Sensor 1 Porta ON/OFF 12/24VDC



| | |
|---------------------|---------------------|
| Índice de Proteção | IP20 |
| Temp. Funcionamento | min. -30 max. +55°C |
| Cabo | 2 Mt |
| Cor | Preto |

| Referência | Alimentação | Saída | Saída Max. | Função | Dimensão | Preço |
|------------|-------------|----------|------------|--------------|--------------------------|-------|
| DS-DM-03 | 12-24VDC | 12-24VDC | 60W | Sensor Porta | Corte 12mm / Altura 18mm | |

Sensor 2 Portas ON/OFF 12/24VDC



| | |
|---------------------|---------------------|
| Índice de Proteção | IP20 |
| Temp. Funcionamento | min. -30 max. +55°C |
| Cabo | 2 Mt |
| Cor | Preto |

| Referência | Alimentação | Saída | Saída Max. | Função | Dimensão | Preço |
|------------|-------------|----------|------------|--------------|--------------------------|-------|
| DS-SM-04 | 12-24VDC | 12-24VDC | 60W | Sensor Porta | Corte 12mm / Altura 18mm | |

Interruptor / Dimmer Touch 12/24VDC



| | |
|---------------------|---------------------|
| Índice de Proteção | IP20 |
| Temp. Funcionamento | min. -30 max. +55°C |
| Cabo | 2 Mt |
| Cor | Preto |

| Referência | Alimentação | Saída | Saída Max. | Função | Dimensão | Preço |
|------------|-------------|----------|------------|--------------|--------------------------|-------|
| DS-CM-01 | 12-24VDC | 12-24VDC | 60W | Dimmer/Touch | Corte 12mm / Altura 18mm | |

Transformadores para sensores Wireless



| Referência | Saída Max. | Saída | Alimentação | Cabo | Dimensões | IP | Preço |
|------------|------------|-------|-------------|----------|-----------|----|-------|
| DS-36-24B | 36W | | | | | | |
| DS-60-24B | 60W | | | | | | |
| DS-100-24B | 100W | 24VDC | 85-265V | 2 metros | | 20 | |
| DS-150-24B | 150W | | | | | | |



Receptor 2,4G 12/24VDC



| | |
|---------------------|---------------------|
| Índice de Proteção | IP20 |
| Temp. Funcionamento | min. -30 max. +55°C |
| Cabo | 2 Mt |
| Cor | Preto |

| Referência | Alimentação | Saída | Saída Max. | Função | Dimensão | Preço |
|------------|-------------|----------|------------|---------------|--------------------------|-------|
| SR-DS-2L | 12-24VDC | 12-24VDC | 60W | Receptor 2,4G | Corte 12mm / Altura 18mm | |



| Referência | Preço |
|------------|-------|
|------------|-------|

SR-002-S

Sensor Wireless HandWave



SR-003-S

Sensor Wireless Porta Duplo



SR-004-S

Sensor Wireless Movimento



SR-005-S

Botão de controlo Digital

Sensor 2,4G
Bateria Lithium
Interface Type-C
Alimentação 5VDC

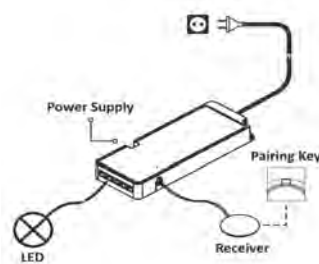





Transformadores IP20

| | Referência | Potência | T. Saída | T. Entrada | Dimensão |
|--|------------|----------|----------|-----------------|------------------|
|  | 499 | 12W | | | 80 x 50 x 30mm |
| | 500 | 24W | | 210 - 240VAC | 75 x 50 x 30mm |
| | 501 | 60W | | 170 - 265VAC | 125 x 55 x 30mm |
|  | 503/45 | 45W | | | 120 x 35 x 25mm |
| | 503/60 | 60W | | | 140 x 35 x 25mm |
| | 503/80 | 80W | | | 140 x 50 x 25mm |
| | 503 | 100W | | | 140 x 50 x 25mm |
| | 503/150 | 150W | | 170 - 265VAC | 180 x 50 x 25mm |
| | 503/200 | 200W | | | 180 x 50 x 25mm |
| | 503/250 | 250W | | | 190 x 60 x 30mm |
| | 503/300 | 300W | 12 VDC | | 220 x 60 x 30mm |
| | 503/400 | 400W | | | 220 x 60 x 30mm |
| | 503/500 | 500W | | | 240 x 50 x 25mm |
|  | 542/A | 150W | | | 210 x 60 x 30mm |
| | 518 | 200W | | | 200 x 100 x 40mm |
| | 518/A | 200W | | | 200 x 80 x 30mm |
| | 519/ND | 250W | | 210 - 240VAC | 200 x 110 x 50mm |
| | 519/A | 250W | | | 200 x 80 x 30mm |
| | 517/N | 350W | | | 220 x 110 x 50mm |
|  | 503/45-24 | 45W | | | 120 x 35 x 25mm |
| | 503/60-24 | 60W | | | 140 x 35 x 25mm |
| | 503/80-24 | 80W | | | 140 x 50 x 25mm |
| | 503/100-24 | 100W | | | 140 x 50 x 25mm |
| | 503/150-24 | 150W | 24 VDC | 170 - 265VAC | 180 x 50 x 25mm |
| | 503/200-24 | 200W | | | 180 x 50 x 25mm |
| | 503/250-24 | 250W | | | 187 x 60 x 30mm |
| | 503/300-24 | 300W | | | 220 x 60 x 30mm |
| 503/400-24 | 400W | | | 220 x 60 x 30mm | |

Transformadores IP 67

| | | | | | |
|--|------------|------|--------------|-----------------|-------------------|
|  | 614/36 | 36W | | | 140 x 25 x 20,5mm |
| | 614/60 | 60W | | 170 - 264VAC | 150 x 38 x 21mm |
| | 614/75 | 75W | | 210 - 240VAC | 190 x 48 x 34mm |
| | 614/100 | 100W | | | 198 x 53 x 19mm |
| | 614/150 | 150W | | | 210 x 60 x 25mm |
| | 614/200 | 200W | 12 VDC | 170 - 264VAC | 235 x 65 x 30mm |
| | 614/300 | 300W | | | 225 x 80 x 30mm |
| 614/500 | 500W | | | 265 x 80 x 35mm | |
|  | 527 | 24W | | | 185 x 25 x 20mm |
| | 525 | 100W | | 210 - 240VAC | 220 x 50 x 40mm |
| | 514 | 150W | | | 210 x 70 x 35mm |
| | 498 | 200W | | | 230 x 95 x 40mm |
|  | 614/36-24 | 36W | | | 130 x 40 x 20mm |
| | 614/60-24 | 60W | | | 150 x 40 x 25mm |
| | 614/100-24 | 100W | | | 205 x 50 x 25mm |
| | 614/150-24 | 150W | 24 VDC | 170 - 264VAC | 210 x 60 x 25mm |
| | 614/200-24 | 200W | | | 235 x 65 x 30mm |
| | 614/300-24 | 300W | | | 225 x 80 x 30mm |
| | 614/500-24 | 500W | | | 265 x 80 x 35mm |
| 518/24IP | 200W | | 210 - 240VAC | 225 x 65 x 40mm | |

Transformadores Piscina IP 67



| Referência | Potência | T. Saída | T. Entrada | Dimensão | Preço |
|------------|----------|----------|--------------|------------------|-------|
| 643 | 60W | 12 VAC | 210 - 240VAC | 100 x 60 x 80mm | |
| 644 | 120W | | | 200 x 130 x 65mm | |

Obs: Transformador de enrolamentos separados para iluminação de Piscinas.

Transformadores Dimáveis 0-10V - TRIAC



| Referência | Potência | Tensão Saída | Tensão Entrada | Tipo | Dimensão |
|-------------|----------|--------------|----------------|------|-----------------|
| 503/100-12D | 100W | 12VDC | | | 160 x 50 x 30mm |
| 503/200-12D | 200W | | 170 - 264VAC | IP20 | 205 x 65 x 30mm |
| 503/100-24D | 100W | 24VDC | | | 230 x 50 x 30mm |
| 503/200-24D | 200W | | | | 290 x 50 x 30mm |

Transformadores Dimáveis DALI



CE RoHS BIS SELV IP67

| Referência | Potência | Tensão Saída | Tensão Entrada | Tipo | Dimensão |
|--------------|----------|--------------|----------------|------|-----------------|
| 614/60-24DA | 60W | | | | 210 x 50 x 30mm |
| 614/100-24DA | 100W | 24VDC | 100 - 240VAC | IP20 | 255 x 50 x 30mm |
| 614/200-24DA | 200W | | | | 305 x 50 x 30mm |

Transformadores Voltagem Ajustável

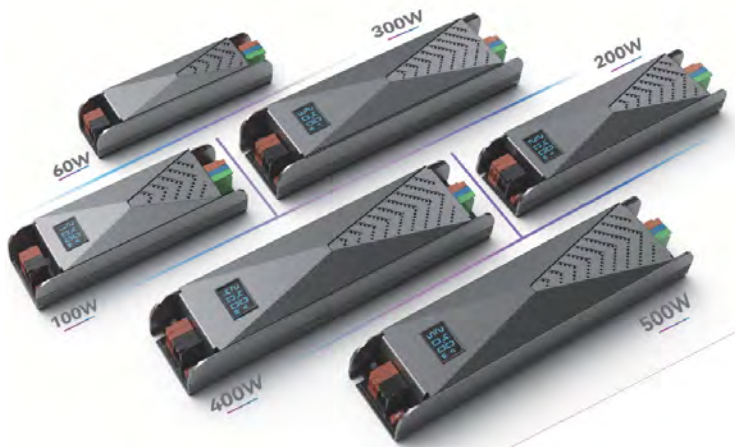

XT XT Series

Innovative Designs

- | Slow start switch
- | Voltage power display
- | brightness adjustment switch

- | Portable terminal application
- | Integrated glue filling process
- | innovative appearance design



- Integrated glue filling machine, semi-gluing technology
- fully moisture-proof, waterproof, insect-proof, and dust-proof,



| Referência | Potência | Tensão Saída | Tensão Entrada | Tipo | Dimensão |
|--------------|----------|--------------|----------------|------|-----------------|
| 503/60-12XT | 60W | | | | 160 x 35 x 25mm |
| 503/100-12XT | 100W | | | | 170 x 50 x 25mm |
| 503/200-12XT | 200W | 12VDC | | | 205 x 50 x 25mm |
| 503/300-12XT | 300W | | | | 230 x 55 x 30mm |
| 503/400-12XT | 400W | | | | 255 x 55 x 30mm |
| 503/60-24XT | 60W | | 180 - 265VAC | IP20 | 160 x 35 x 25mm |
| 503/100-24XT | 100W | | | | 170 x 50 x 25mm |
| 503/200-24XT | 200W | | | | 205 x 50 x 25mm |
| 503/300-24XT | 300W | 24VDC | | | 230 x 55 x 30mm |
| 503/400-24XT | 400W | | | | 255 x 55 x 30mm |
| 503/500-24XT | 500W | | | | 255 x 55 x 30mm |

Transformadores Classe 2

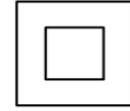

CLASSE II

| Referência | Potência | Tensão Saída | Tensão Entrada | Tipo | Dimensão |
|--------------|----------|--------------|----------------|------|-----------------|
| 614/20-24C2 | 20W | | | | 140 x 25 x 25mm |
| 614/40-24C2 | 40W | 24VDC | 100-240VAC | IP67 | 140 x 45 x 25mm |
| 614/100-24C2 | 100W | | | | 190 x 50 x 40mm |

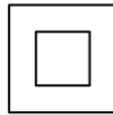

CLASSE II

Input Voltage: 100-240Vac.
 24V Constant voltage output.
 Efficiency up to 90%/ THD<10% EN61000-3-2 CLASS A
 Surge protection: 8-24W: 2KV, 30-150W: 4KV

Protection level: IP65

SCP/OTP/OVP protection.

Authentication:8-24W:CCC,CE,UL,FCC 30-150W:(LVD,EMC)CE,UL,FCC

| Referência | Potência | Tensão Saída | Tensão Entrada | Tipo | Dimensão |
|----------------|----------|--------------|----------------|------|-----------------|
| 614/16-24-RAP | 16W | | | | 70 x 35 x 25mm |
| 614/30-24-RAP | 30W | | | | 120 x 35 x 25mm |
| 614/75-24-RAP | 75W | 24VDC | 100-240VAC | IP65 | 160 x 40 x 35mm |
| 614/100-24-RAP | 100W | | | | 170 x 55 x 40mm |
| 614/150-24-RAP | 150W | | | | 170 x 55 x 40mm |

Transformadores + Dimmer Triac 24VDC

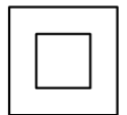
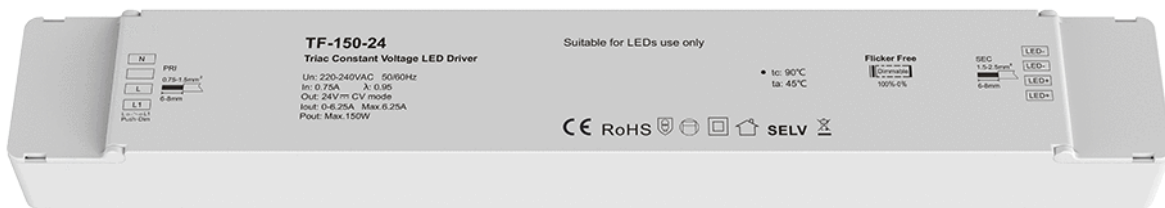
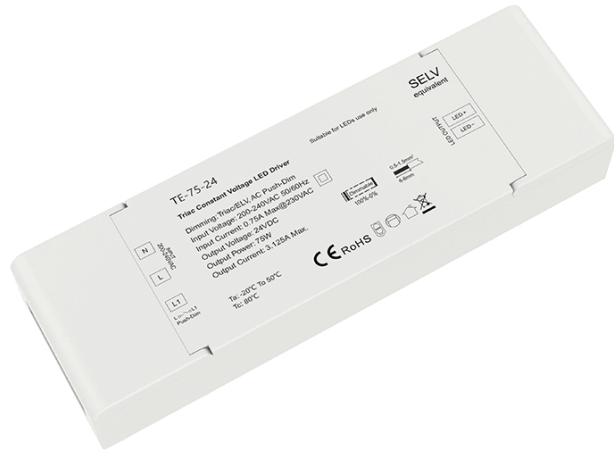

CLASSE II

| | | | |
|---------------------|--------------------------|--------------------|----------------------|
| Sinal de Entrada | PUSH DIM | Proteção | Polaridade Invertida |
| Protocolo | IEC 62386-102, 62386-207 | Certificado | CE |
| Temp. Funcionamento | min. -30 max.+55°C | Índice de Proteção | IP20 |

| Referência | Alimentação | Saída | Saída Máx. | Função | Dimensão |
|-------------|-------------|---------|--------------|----------------------|-----------------|
| SW-TE40-24 | | | 24VDC - 40W | | 170 x 45 x 30mm |
| SW-TE75-24 | 85-265VAC | 1 Canal | 24VDC - 75W | Dimmer + Push Switch | 180 x 55 x 30mm |
| SW-TE150-24 | | | 24VDC - 150W | | 235 x 65 x 35mm |

MEAN WELL GAMA COMPLETA



Os preços dos transformadores Meanwell estão em constante oscilação. Sujeito sempre a confirmação de valor.

| | Referência | Potência | T. Saída | T. Entrada | Dimensão | Preço |
|---|---|-------------|-------------------|--------------|---------------------|--------|
|   | MW/15 | 15W | | 85 - 264VAC | 62,5 x 51 x 28mm | |
| | MW/25 | 25W | | | 78 x 51 x 28mm | |
| | MW/35 | 35W | | | 99 x 82 x 30mm | |
| | MW/75 | 75W | | | 99 x 97 x 30mm | |
| | MW/100 | 100W | | | 129 x 97 x 30mm | |
| | MW/150 | 150W | | | 159 x 97 x 30mm | |
| | MW/200 | 200W | | | 215 x 115 x 30mm | |
| | MW/500 | 500W | | | 230 x 127 x 40,5mm | |
|   | MW/LPV20-12 | 20W | 12 VDC | 90 - 264VAC | 118 x 35 x 26mm | |
| | MW/LPV35-12 | 35W | | | 148 x 40 x 30mm | |
| | MW/LPV60-12 | 60W | | | 162,5 x 42,5 x 32mm | |
| | MW/LPV100-12 | 100W | | | 190 x 52 x 37mm | |
| | MW/LPV150-12 | 150W | | | 191 x 63 x 37,5mm | |
| | MW/ELG200-12 | 200W | | | 220 x 71 x 37,5mm | |
| | MW/ELG300-12 | 300W | | | 219 x 63 x 35,5mm | |
| |   | MW/NPF-40 | | | 40W | |
| | | | | | | |
|   | MW/D16 | 15W | | 90 - 264VAC | 77 x 40 x 29mm | |
| | MW/D25 | 25W | | | 84 x 57 x 29,5mm | |
| | MW/D35 | 35W | | | 84 x 57 x 29,5mm | |
|   | MW/15-24 | 15W | 24 VDC | 85 - 264VAC | 62,5 x 51 x 28mm | |
| | MW/25-24 | 25W | | | 78 x 51 x 28mm | |
| | MW/35-24 | 35W | | | 99 x 82 x 30mm | |
| | MW/75-24 | 75W | | | 99 x 97 x 30mm | |
| | MW/100-24 | 100W | | | 129 x 97 x 30mm | |
| | MW/150-24 | 150W | | | 159 x 97 x 30mm | |
| | MW/200-24 | 200W | | | 215 x 115 x 30mm | |
| |   | MW/LPV20-24 | | | 20W | 24 VDC |
| MW/LPV35-24 | | 35W | 148 x 40 x 30mm | | | |
| MW/LPV60-24 | | 60W | 162 x 42 x 30mm | | | |
| MW/LPV100-24 | | 100W | 190 x 52 x 37mm | | | |
| MW/LPV150-24 | | 150W | 191 x 63 x 37,5mm | | | |
| MW/ELG200-24 | | 200W | 220 x 71 x 37,5mm | | | |
| MW/ELG300-24 | | 300W | 219 x 63 x 35,5mm | | | |
|   | MW/Q60 | 60W | 16 VDC | 210 - 240VAC | 90 x 40 x 100mm | |
| | | | | | | |
|   | MW/D8-24 | 8W | 24 VDC | 90 - 305VAC | 60 x 30 x 23,5mm | |



| Referência | Potência | Tensão Saída | Tensão Entrada | Dimensão |
|---------------|----------|--------------|----------------|-----------------|
| MW/UHP-350-12 | 350W | 12 VDC | 90-264VAC | 220 x 62 x 31mm |
| MW/UHP-500-12 | 500W | | | 232 x 81 x 31mm |
| MW/UHP-350-24 | 350W | 24 VDC | 90-264VAC | 220 x 62 x 31mm |
| MW/UHP-500-24 | 500W | | | 232 x 81 x 31mm |

Transformadores Mean Well Dimáveis IP67



| Referência | Potência | Tensão Saída | Tensão Entrada | Dimensão |
|--------------|----------|--------------|-------------------|-------------------|
| MW/LPF60D-12 | 60W | 12VDC | 90-305VAC | 162,5 x 43 x 32mm |
| MW/HLG120-12 | 120W | | 90-264VAC | 220 x 68 x 38,8mm |
| MW/HLG150-12 | 150W | | 228 x 68 x 38,8mm | |
| MW/LPF60D-24 | 60W | 24VDC | 90-305VAC | 162,5 x 43 x 32mm |
| MW/HLG100-24 | 100W | | 90-264VAC | 220 x 68 x 38,8mm |
| MW/HLG150-24 | 150W | | 228 x 68 x 38,8mm | |

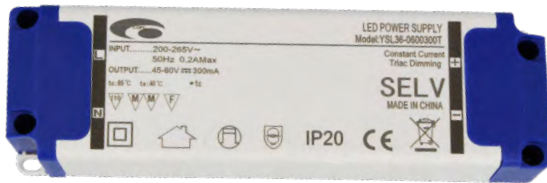

Drives CC TRIAC Dimáveis P/Paineis LED

IP
20

| Referência | Potência | T. Entrada | T. Saída | Corrente | PF | Dimensão | Preço |
|------------|----------|--------------|-------------|----------|-----|-----------------|-------|
| DRI15/18D | 15 - 18w | 200 - 265VAC | 45 - 60 VDC | 300mA | 0,9 | 133 x 42 x 30mm | |
| DRI18/22D | 18 - 22w | | 60 - 75 VDC | 300mA | | 160 x 58 x 21mm | |
| DRI23/27D | 23 - 27w | | 75 - 90 VDC | 300mA | | 185 x 64 x 23mm | |
| DRI39/47D | 39 - 48w | | 70 - 85 VDC | 550mA | | 170 x 57 x 33mm | |

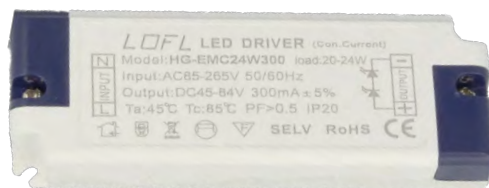
IP
20

| Referência | Potência | T. Entrada | T. Saída | Corrente | PF | Dimensão | Preço |
|------------------|----------|-------------|-------------|----------|-----|-----------------|-------|
| DRISO/EMC 8/12W | 8 - 12w | 85 - 265VAC | 20 - 42 VDC | 300mA | 0,5 | 92 x 34 x 22mm | |
| DRISO/EMC 15/18W | 15 - 18w | | 30 - 63 VDC | | | 92 x 34 x 22mm | |
| DRISO/EMC 20/24W | 20 - 24w | | 45 - 84 VDC | | | 110 x 40 x 24mm | |

Drives CC

IP
40

| Referência | Potência | T. Saída | T. Entrada | Corrente | Dimensão | Preço |
|------------|----------|-------------|--------------|----------|-----------------|-------|
| 551 | 12*1 Led | 15 - 30 VDC | 220 - 240VAC | 420mA | 115 x 47 x 28mm | |

IP
40

| Referência | Potência | T. Saída | T. Entrada | Corrente | Dimensão | Preço |
|------------|------------|------------|--------------|----------|----------------|-------|
| 553/7 | 4 a 7W Led | 14- 28 VDC | 220 - 240VAC | 300mA | 60 x 30 x 24mm | |

Drives CV

IP
40

| Referência | Potência | T. Saída | T. Entrada | Corrente | Dimensão | Preço |
|------------|----------|----------|--------------|----------|-----------------|-------|
| 639 | 24W | 12 VDC | 110 - 240VAC | 2000mA | 110 x 45 x 28mm | |
| 640 | 27W | | | 2250mA | 140 x 45 x 28mm | |

Drive Dimável 0-10v CC P/Painéis LED 60x60CM / 120x30CM

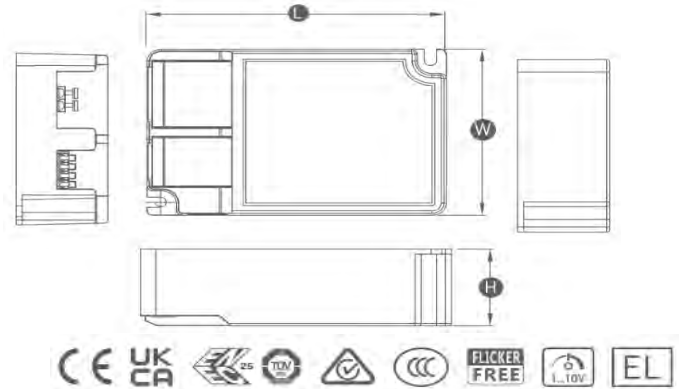

| | | | |
|---------------------|---------------------|--------------------|--------------------|
| Dimável | DALI | Proteção | CLASS II |
| Output | SELV | Flicker Free | Pst LM <1,SVM <0,4 |
| Temp. Funcionamento | min. -20 max. +45°C | Índice de Proteção | IP20 |

| Referência | Potência | T. Entrada | T. Saída | Corrente | PF | Dimensão | Preço |
|------------|----------|-----------------|-------------|------------|------|-----------------|-------|
| BK-KUL040 | 40W | 180 - 264VAC/DC | 24 - 42 VDC | 0,60-1,05A | 0,95 | 103 x 69 x 31mm | |

Drive Dimável DALI CC P/Painéis LED 60x60CM / 120x30CM

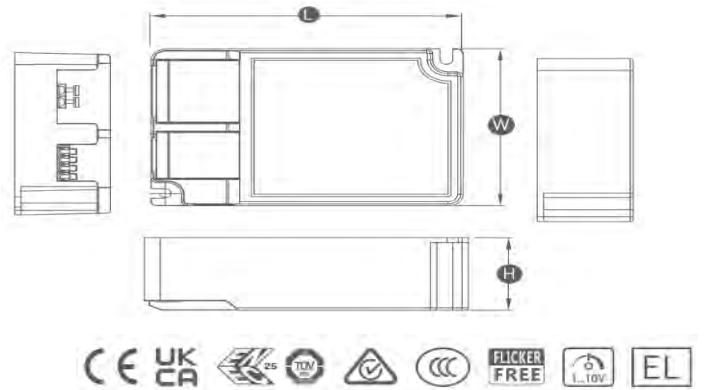

| | | | |
|---------------------|---------------------|--------------------|--------------------|
| Dimável | DALI | Proteção | CLASS II |
| Output | SELV | Flicker Free | Pst LM <1,SVM <0,4 |
| Temp. Funcionamento | min. -20 max. +45°C | Índice de Proteção | IP20 |

| Referência | Potência | T. Entrada | T. Saída | Corrente | PF | Dimensão | Preço |
|------------|----------|-----------------|------------|------------|------|-----------------|-------|
| BK-DEL042 | 42W | 180 - 264VAC/DC | 6 - 42 VDC | 0,45-1,10A | 0,95 | 103 x 69 x 31mm | |

Drive Dimável 0-10v CC P/Painéis LED 60x60CM / 120x30CM



| | | | |
|---------------------|---------------------|--------------------|--------------------|
| Dimável | 0-10v | Proteção | CLASS II |
| Output | SELV | Flicker Free | Pst LM <1,SVM <0,4 |
| Temp. Funcionamento | min. -20 max. +45°C | Índice de Proteção | IP67 |

| Referência | Potência | T. Entrada | T. Saída | Corrente | PF | Dimensão | Preço |
|------------|----------|-----------------|-------------|------------|------|-----------------|-------|
| DR-50W | 50W | 100 - 277VAC/DC | 30 - 56 VDC | 800-1500mA | 0,97 | 126 x 41 x 29mm | |

34

Track Lights



Track Lights



Especificações técnicas
 Material: Alumínio + Vidro
 Tempo de vida: 50.000H Led
 Cobertura: Vidro

LIFUD EPISTAR
 LED Driver



24°

IP
 22

FP
 0,90

CRI
 >85

| Referência | Cor | Potência | Lumens | Temp. Cor | Voltagem | Base | Dimensão | Preço |
|------------|--------|----------|--------|----------------|------------|-----------------|--------------|-------|
| 224/30WP-4 | Preto | 30 W | 3000 | 3000K ou 4000K | 200-240VAC | Calha Trifásica | L215 x ø90mm | |
| 224/30WB-4 | Branco | | | | | | | |



Especificações técnicas
 Material: Alumínio + Vidro
 Tempo de vida: 50.000H Led
 Cobertura: Vidro

LIFUD EPISTAR
 LED Driver



24°

IP
 22

FP
 0,90

CRI
 >85

| Referência | Cor | Potência | Lumens | Temp. Cor | Voltagem | Base | Dimensão | Preço |
|------------|--------|----------|--------|----------------|------------|-----------------|--------------|-------|
| 211/3P | PRETO | 30 W | 3000 | 3000K ou 4000K | 200-240VAC | Calha Trifásica | L215 x ø90mm | |
| 211/3B | BRANCO | | | | | | | |



Especificações técnicas
 Material: Alumínio + Vidro
 Tempo de vida: 30.000H Led
 Tipo Drive: Interno

EPISTAR

38°

IP
 40

FP
 0,90

CRI
 >85

| Referência | Cor | Potência | Lumens | Temp. Cor | Voltagem | Base | Dimensão | Preço |
|------------|-------|----------|--------|-----------|-------------|-----------------|---------------|-------|
| 230/PWB | Preto | 30 W | 2 700 | 4000K | 85 - 250VAC | Calha Trifásica | L236 x ø110mm | |

Track Light Trifásico ZOOMABLE



| | | | |
|----------|---------------------|---------------------|---------------------|
| LED | Luminus-CXM 9 | Temp. Funcionamento | min. -10 max. +35°C |
| Material | 1070 Pure Aluminium | Ângulo de Abertura | 20° - 55° |
| CRI | 90 | IP | 20 |

| Referência | Cor | Potência | Lumens | Temp. Cor | Voltagem | Base | Dimensão | Preço |
|-------------|--------|----------|--------|-------------|--------------|-----------------|--------------|-------|
| SW-ZP8-4 | Preto | 8W | 720 | 3000K-4000K | 200 - 250VAC | Calha Trifásica | L135 x ø50mm | |
| SW-ZB18-CCT | Branco | 18W | 1 713 | CCT | | | L175 x ø72mm | |
| SW-ZP24-CCT | Preto | 24 W | 2 350 | CCT | | | L172 x ø73mm | |
| SW-ZB24-CCT | Branco | | | | | | | |
| SW-ZB30-CCT | Branco | 30W | 2 940 | CCT | | | L176 x ø80mm | |

Track Light Trifásico GU10

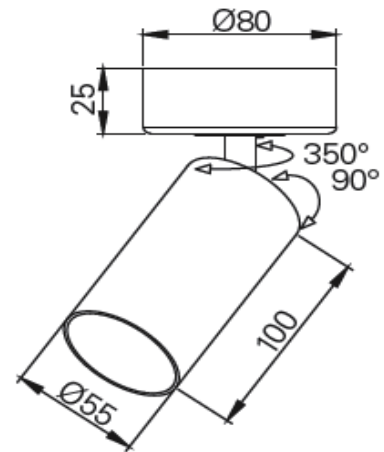

| Referência | Cor | Casquilho | Voltagem | Dimensão | Preço |
|------------|--------|-----------|------------|-------------|-------|
| LL-TSB | Branco | GU10 | 200-240VAC | 100 x ø55mm | |
| LL-TSP | Preto | | | | |

Calha Track Light Trifásica



| Referência | Cor | Acessório | Fios | Dimensão | Preço |
|------------|--------|----------------|------|----------|-------|
| 226/1 | Branco | Calha Saliente | 4 | 1Mt. | |
| 226/1B | Preto | | | | |
| 226/2 | Branco | | | 2Mt. | |
| 226/2B | Preto | | | | |

Conectores

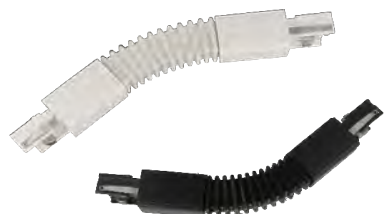

| Referência | Cor | Acessório | Fios | Material |
|------------|--------|-------------------|------|----------|
| 227/FLEXB | Branco | Conector flexível | 4 | Plástico |
| 227/FLEXP | Preto | | | |



| Referência | Cor | Acessório | Fios | Material |
|------------|--------|---------------|------|----------|
| 227/L | Branco | Conector em L | 4 | Plástico |
| 227/LB | Preto | | | |



| Referência | Cor | Acessório | Fios | Material |
|------------|--------|---------------|------|----------|
| 227/T | Branco | Conector em T | 4 | Plástico |
| 227/TB | Preto | | | |



| Referência | Cor | Acessório | Fios | Material |
|------------|--------|---------------|------|----------|
| 227/X | Branco | Conector em X | 4 | Plástico |



| Referência | Cor | Acessório | Fios | Material |
|------------|--------|---------------|------|----------|
| 227/I | Branco | Conector em I | 4 | Plástico |
| 227/IB | Preto | | | |



| Referência | Cor | Acessório | Fios | Material |
|------------|--------|---------------------|------|----------|
| 228/2PC | Branco | Conector em I duplo | 4 | Plástico |
| 228/2PCB | Preto | | | |



| Referência | Cor | Acessório | Fios | Material |
|------------|--------|---------------------|------|----------|
| 228/PC | Branco | Conector de ligação | 4 | Plástico |
| 228/PCB | Preto | | | |



| Referência | Cor | Acessório | Fios | Material |
|------------|--------|---------------------|------|----------|
| 228/CAP | Branco | Topo final de calha | 4 | Plástico |
| 228/CAPB | Preto | | | |

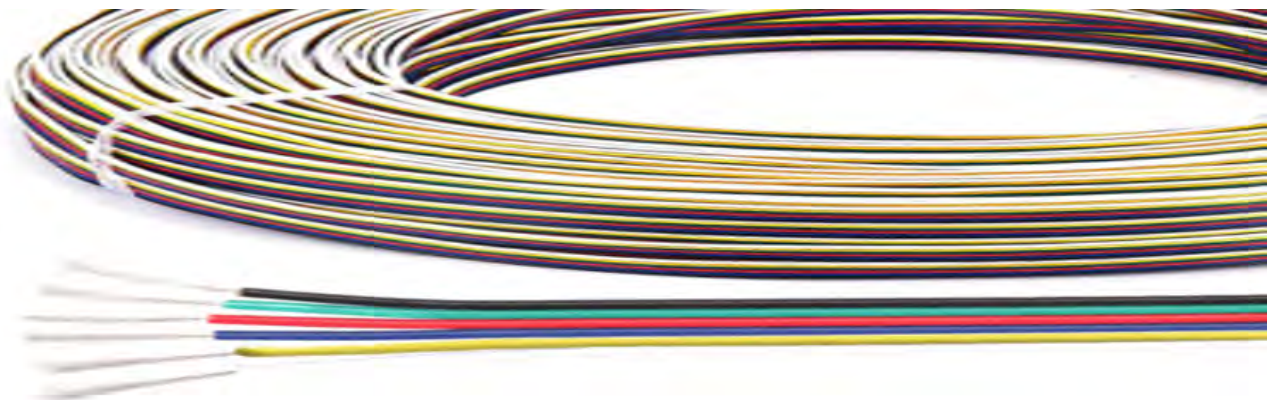

Conectores



| Referência | Características | Preço |
|------------|------------------------|-------|
| T8/1S | Conector T8 de um lado | |



| Referência | Características |
|------------|--|
| 509/WP | Conector 2 fios (3,5mm) Macho - Fêmea, resistente á agua |



| Referência | Características |
|------------|--|
| 511 | Conector 2 fios Macho - Fêmea, fita simples, resistente á agua |
| 512 | Conector 4 fios Macho - Fêmea, fita simples, resistente á agua |



| Referência | Características |
|------------|--|
| 610 | Conetor 2 fios, Macho - Fêmea fita simples |



| Referência | Características |
|------------|---|
| 617 | Conector rápido, para fita 8mm, ligação a transformador por "jack" |
| 618 | Conector rápido, para fita 10mm, ligação a transformador por "jack" |



| Referência | Características |
|------------|--|
| 590 | Conector rápido, c/ 10 cm de fio 2x0,50mm para fita 8mm |
| 591 | Conector rápido, c/ 10 cm de fio 2x0,50mm para fita 10mm |



| Referência | Características |
|------------|--|
| 592 | Conector rápido, 4 fios para fita RGB 10mm. Obs: Ligador 4 x0,50mm colorido, para fita RGB |



| Referência | Características |
|------------|--|
| 590/L | União de conector rápido, para fita simples de 8mm. |
| 591/L | União de conector rápido, para fita simples de 10mm. |



| Referência | Características |
|------------|---|
| 592/L | União conector rápido, 4 fios para fita RGB 10mm. |

Obs: Preço de venda unitário

Casquilho GU10 s/repique



| Referência | Características | Preço |
|------------|--------------------------------------|-------|
| 594 | Casquilho Cerâmica GU10 S/ repicagem | |

Obs: Preço de venda unitário

Fio de 2 Condutores



| Referência | Características | Preço |
|-------------------------------------|----------------------|-------|
| FIO/2L | Cabo de 2 Condutores | |
| Obs: Preço de venda ao metro | | |

Fio RGB

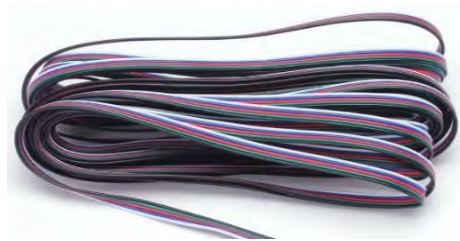

| Referência | Características | Preço |
|--|---|-------|
| FIO/RGB | Cabo 4 cores espalmado 4x0,50mm, para fitas RGB | |
| Obs: Preço de venda Bobine 100Mt. | | |

Fio RGB+W



| Referência | Características | Preço |
|-------------------------------------|---|-------|
| FIO/RGB-6 | Cabo 5 cores espalmado 4x0,50mm, para fitas RGB+W | |
| Obs: Preço de venda ao metro | | |

Fio RGB+W / WW



| Referência | Características | Preço |
|-------------------------------------|--|-------|
| FIO/RGB-6-3 | Cabo 6 cores espalmado 5x0,50mm, para fitas RGB+W / WW | |
| Obs: Preço de venda ao metro | | |

Conversores

| | | | |
|---|------------|-----------------------|------------------------------|
|  | Referência | Características | Preço |
| | 560 | Conversor GU10 / E27 | |
| | | | Obs: Preço de venda ao metro |
|  | Referência | Características | Preço |
| | 561 | Conversor E27 / GU10 | |
| | | | Obs: Preço de venda ao metro |
|  | Referência | Características | Preço |
| | 593 | Conversor E14 / GU10 | |
| | | | Obs: Preço de venda ao metro |
|  | Referência | Características | Preço |
| | 562 | Conversor E14 / E27 | |
| | | | Obs: Preço de venda ao metro |
|  | Referência | Características | Preço |
| | 563 | Conversor E27 / E14 | |
| | | | Obs: Preço de venda ao metro |
|  | Referência | Características | Preço |
| | 564 | Conversor E27 / 2xE27 | |
| | | | Obs: Preço de venda ao metro |
|  | Referência | Características | Preço |
| | 613 | Conversor E27 / E40 | |
| | | | Obs: Preço de venda ao metro |
|  | Referência | Características | Preço |
| | 613/E40 | Conversor E40 / E27 | |
| | | | Obs: Preço de venda ao metro |

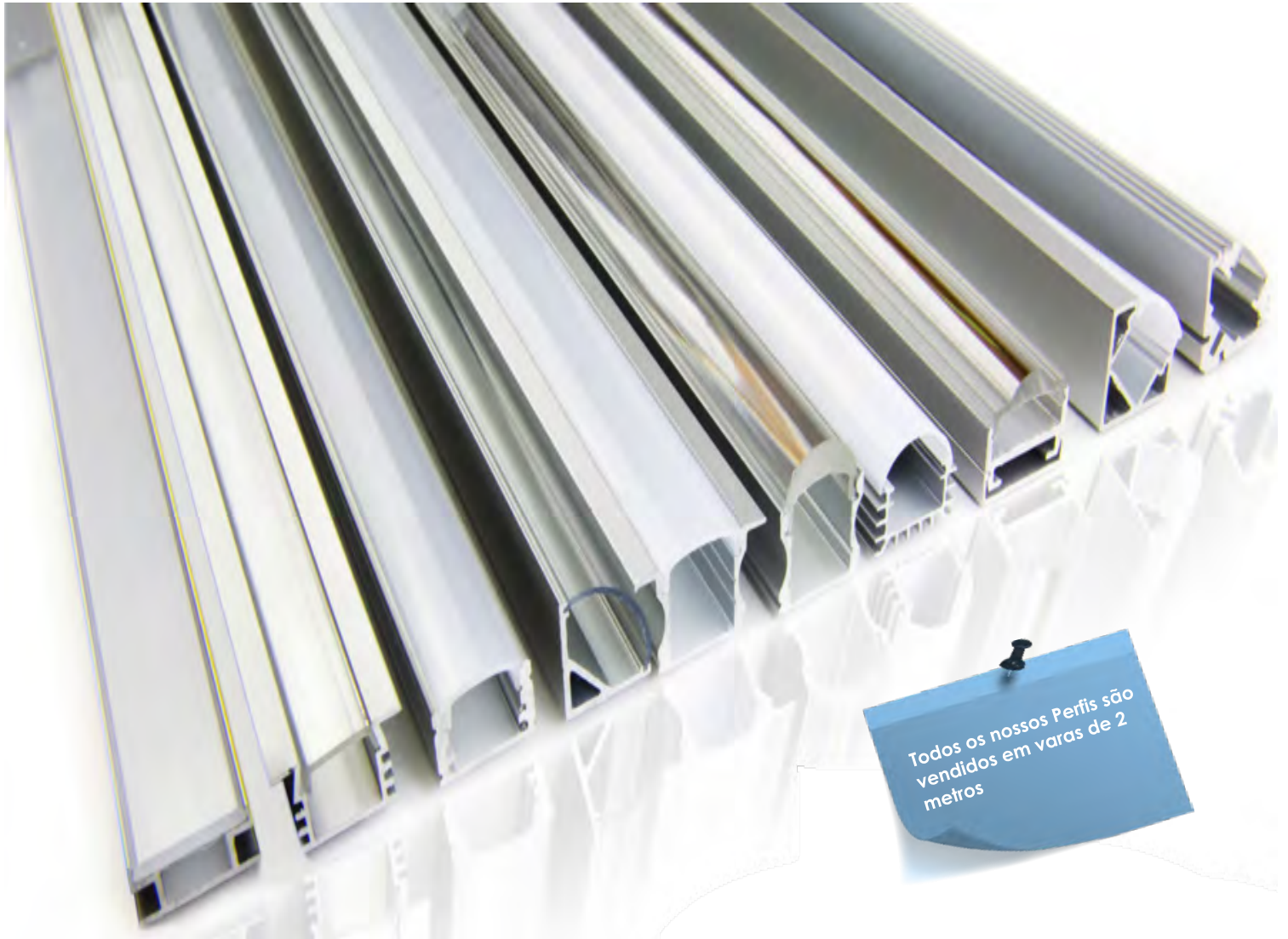

Perfil para fita LED



| Referência | Cor | Difusor | Preço/Mt |
|-------------------|----------|-------------|------------|
| 777 | Alumínio | Sem Difusor | |
| Dimensão Exterior | Alumínio | Difusor | Superfície |
| 17 x 7mm | 6063-T5 | PMMA | Anodizada |

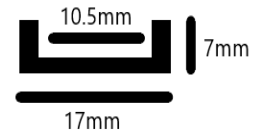

| Referência | Cor | Difusor | Preço/Mt |
|-------------------|----------|--------------|------------|
| 777/2 | Alumínio | Opalino | |
| 777/2TP | | Transparente | |
| Dimensão Exterior | Alumínio | Difusor | Superfície |
| 16 x 16mm | 6063-T5 | PMMA | Anodizada |

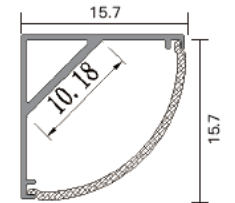

| Referência | Cor | Difusor | Preço/Mt |
|-------------------|----------|---------|------------|
| 777/3 | Alumínio | Opalino | |
| Dimensão Exterior | Alumínio | Difusor | Superfície |
| 18,8 x 18,8mm | 6063-T5 | 12,2mm | Anodizada |

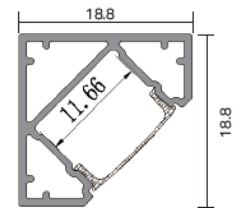

| Referência | Cor | Difusor | Preço/Mt |
|-------------------|----------|---------------|------------|
| 777/4 | Alumínio | Opalino | |
| 777/4TP | | Transparente | |
| 777/4B | Branco | Opalino | |
| 777/4P | Preto | Opalino/Preto | |
| Dimensão Exterior | Alumínio | Difusor | Superfície |
| 17,5 x 7mm | 6063-T5 | PMMA | Anodizada |

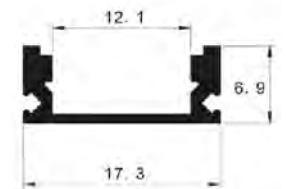

| Referência | Cor | Difusor | Preço/Mt |
|-------------------|----------|---------------|------------|
| 777/5 | Alumínio | Opalino | |
| 777/5TP | | Transparente | |
| 777/5B | Branco | Opalino | |
| 777/5P | Preto | Opalino/Preto | |
| Dimensão Exterior | Alumínio | Difusor | Superfície |
| 24,5 x 7mm | 6063-T5 | PMMA | Anodizada |

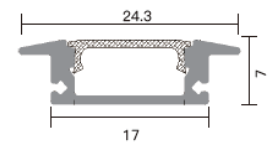

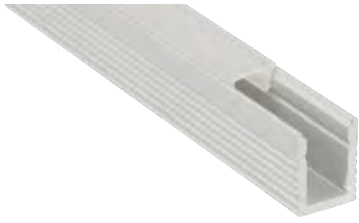

| Referência | Cor | Difusor | Preço/Mt |
|-------------------|----------|---------|------------|
| 777/5M | Alumínio | Opalino | |
| Dimensão Exterior | Alumínio | Difusor | Superfície |
| 8 x 9mm | 6063-T5 | PMMA | Anodizada |

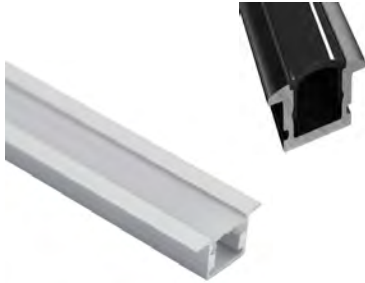
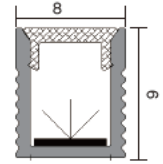

| Referência | Cor | Difusor | Preço/Mt |
|-------------------|----------|---------|------------|
| 777/5MAB | Branco | Opalino | |
| 777/5MAP | Preto | | |
| Dimensão Exterior | Alumínio | Difusor | Superfície |
| 7,8 x 9mm | 6063-T5 | PMMA | Anodizada |

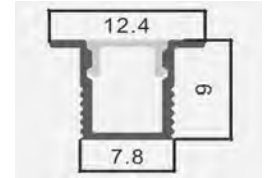

| Referência | Cor | Difusor | Preço/Mt |
|-------------------|----------|---------------|------------|
| 777/6 | Alumínio | Opalino | |
| 777/6TP | | Transparente | |
| 777/6B | Branco | Opalino | |
| 777/6P | Preto | Opalino/Preto | |
| Dimensão Exterior | Alumínio | Difusor | Superfície |
| 24,5 x 17mm | 6063-T5 | PMMA | Anodizada |

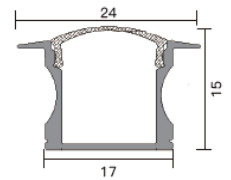

| Referência | Cor | Difusor | Preço/Mt |
|-------------------|----------|---------------|------------|
| 777/7 | Alumínio | Opalino | |
| 777/7TP | | Transparente | |
| 777/7B | Branco | Opalino | |
| 777/7P | Preto | Opalino/Preto | |
| Dimensão Exterior | Alumínio | Difusor | Superfície |
| 24,5 x 17mm | 6063-T5 | PMMA | Anodizada |

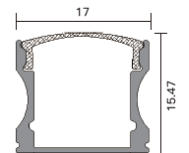

| Referência | Cor | Difusor | Preço/Mt |
|-------------------|----------|---------|------------|
| 777/8 | Alumínio | Opalino | |
| Dimensão Exterior | Alumínio | Difusor | Superfície |
| 20,8mm | 6063-T5 | PMMA | Anodizada |





| Referência | Cor | Difusor | Preço/Mt |
|-------------------|----------|---------|------------|
| 777/9 | Alumínio | Opalino | |
| Dimensão Exterior | Alumínio | Difusor | Superfície |
| 20 x 20mm | 6063-T5 | PMMA | Anodizada |

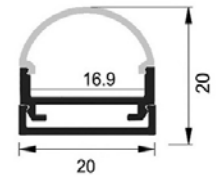

| Referência | Cor | Difusor | Preço/Mt |
|-------------------|----------|---------|------------|
| 777/11 | Opalino | Opalino | |
| Dimensão Exterior | Alumínio | Difusor | Superfície |
| 23 x 10mm | 6063-T5 | PMMA | Anodizada |

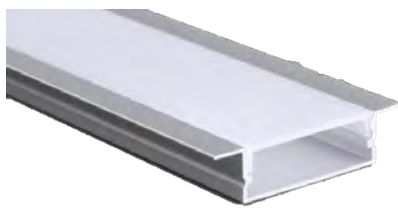
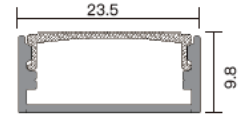

| Referência | Cor | Difusor | Preço/Mt |
|-------------------|----------|---------|------------|
| 777/12 | Opalino | Opalino | |
| Dimensão Exterior | Alumínio | Difusor | Superfície |
| 30 x 10mm | 6063-T5 | PMMA | Anodizada |

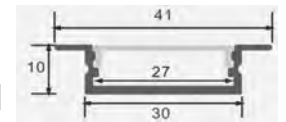

| Referência | Cor | Difusor | Preço/Mt |
|-------------------|----------|---------|------------|
| 777/13 | Alumínio | Opalino | |
| Dimensão Exterior | Alumínio | Difusor | Superfície |
| 18 x 41mm | 6063-T5 | PMMA | Anodizada |

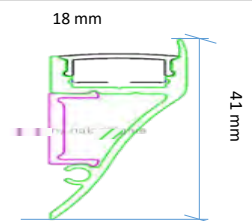

| Referência | Cor | Difusor | Preço/Mt |
|-------------------|----------|---------|------------|
| 777/15B | Branco | Opalino | |
| 777/15P | Preto | | |
| Dimensão Exterior | Alumínio | Difusor | Superfície |
| 50 x 35mm | 6063-T5 | PMMA | Anodizada |

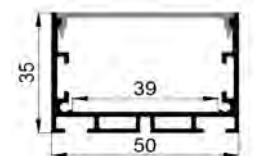

| Referência | Cor | Difusor | Preço/Mt |
|-------------------|----------|---------|------------|
| 777/16B | Branco | Opalino | |
| 777/16P | Preto | | |
| Dimensão Exterior | Alumínio | Difusor | Superfície |
| 64,88 x 36mm | 6063-T5 | PMMA | Anodizada |

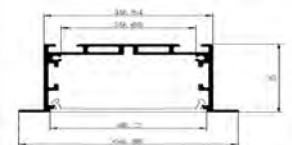
IP
67

| Referência | Cor | Difusor | Preço/Mt |
|-------------------|----------|-------------------|------------|
| 777/18 | Alumínio | Opalino | |
| Dimensão Exterior | Alumínio | Dimensão Interior | Superfície |
| 25 x 8mm | 6063-T5 | 12,7mm | Anodizada |

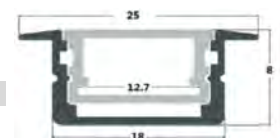

IP
67

| Referência | Cor | Preço/Mt |
|-------------------|-------------------|------------|
| 777/19 | Alumínio | |
| Dimensão Exterior | Dimensão Interior | |
| 27,1 x 11mm | 12,2mm | |
| Alumínio | Difusor | Superfície |
| 6063-T5 | PMMA | Anodizada |

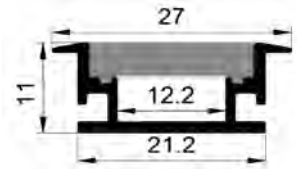
IP
67

| Referência | Cor | Preço/Mt |
|-------------------|-------------------|------------|
| 777/20 | Alumínio | |
| Dimensão Exterior | Dimensão Interior | |
| 21,3 x 25,9mm | 12,5mm | |
| Alumínio | Difusor | Superfície |
| 6063-T5 | PMMA | Anodizada |

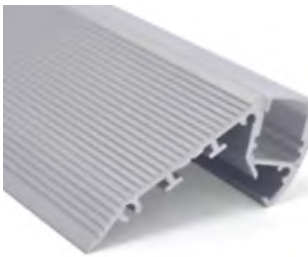
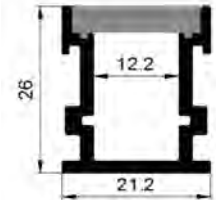

| Referência | Cor | Preço/Mt |
|-------------------|-------------------|------------|
| 777/21 | Alumínio | |
| Dimensão Exterior | Dimensão Interior | |
| 54,6 x 66,3mm | 14,3mm | |
| Alumínio | Difusor | Superfície |
| 6063-T5 | PMMA | Anodizada |

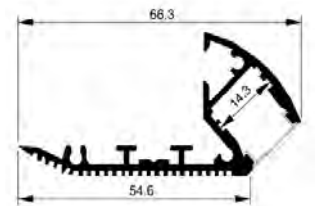

| Referência | Cor | Preço/Mt |
|-------------------|-------------------|------------|
| 777/22 | Alumínio | |
| Dimensão Exterior | Dimensão Interior | |
| 29,7 x 29,7mm | 20,55mm | |
| Alumínio | Difusor | Superfície |
| 6063-T5 | PMMA | Anodizada |

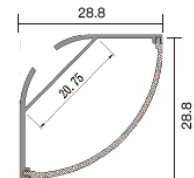

| Referência | Cor | Preço/Mt |
|-------------------|-------------------|------------|
| 777/23 | Alumínio | |
| Dimensão Exterior | Dimensão Interior | |
| 20,3 x 27mm | 17,1mm | |
| Alumínio | Difusor | Superfície |
| 6063-T5 | PMMA | Anodizada |

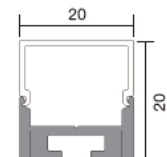

| Referência | Cor | Preço/Mt |
|-------------------|-------------------|------------|
| 777/23R | Alumínio | |
| Dimensão Exterior | Dimensão Interior | |
| 20,3 x 27mm | 17,1mm | |
| Alumínio | Difusor | Superfície |
| 6063-T5 | PMMA | Anodizada |

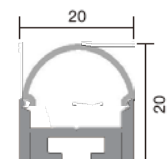



| Referência | Cor | Preço/Mt |
|-------------------|-------------------|------------|
| 777/24 | Alumínio | |
| Dimensão Exterior | Dimensão Interior | |
| 24 x 19mm | 12,6mm | |
| Alumínio | Difusor | Superfície |
| 6063-T5 | PMMA | Anodizada |

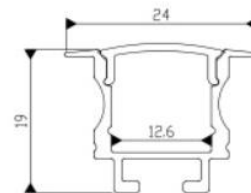

| Referência | Cor | Preço/Mt |
|-------------------|-------------------|------------|
| 777/25 | Alumínio | |
| Dimensão Exterior | Dimensão Interior | |
| 50 x 75mm | 40,4mm | |
| Alumínio | Difusor | Superfície |
| 6063-T5 | PMMA | Anodizada |

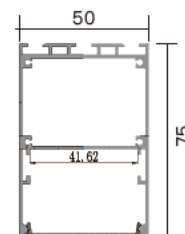

| Referência | Cor | Preço/Mt |
|-------------------|-------------------|------------|
| 777/27 | Alumínio | |
| Dimensão Exterior | Dimensão Interior | |
| 18 x 6mm | 13mm | |
| Alumínio | Difusor | Superfície |
| 6063-T5 | PMMA | Anodizada |

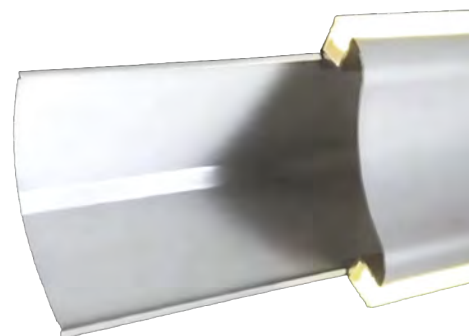
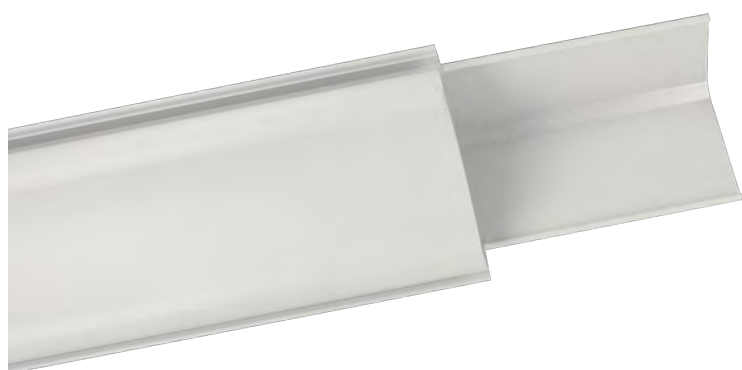
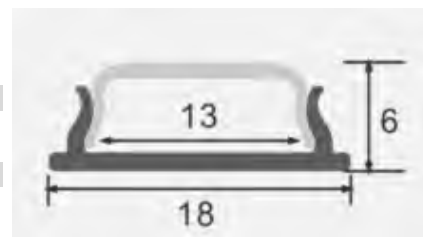

| Referência | Dimensão Interior | Dimensão Exterior | Cor | Superfície | Difusor | Alumínio | Preço/Mt |
|------------|-------------------|-------------------|----------|---------------|---------|----------|----------|
| 777/30B | 12,5mm | 69 x 69mm | Alumínio | Lacado Branco | PMMA | 6063-T5 | |



| Referência | Cor | Preço/Mt |
|-------------------|-------------------|------------|
| 777/28 | Alumínio | |
| Dimensão Exterior | Dimensão Interior | |
| 61,4 x 14mm | 20,66mm | |
| Alumínio | Difusor | Superfície |
| 6063-T5 | PMMA | Anodizada |

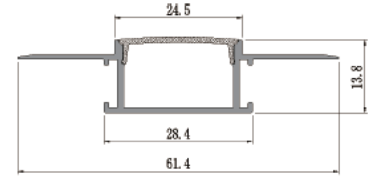

| Referência | Cor | Preço/Mt |
|-------------------|-------------------|------------|
| 777/29 | Alumínio | |
| Dimensão Exterior | Dimensão Interior | |
| 56 x 15mm | 12,5mm | |
| Alumínio | Difusor | Superfície |
| 6063-T5 | PMMA | Anodizada |

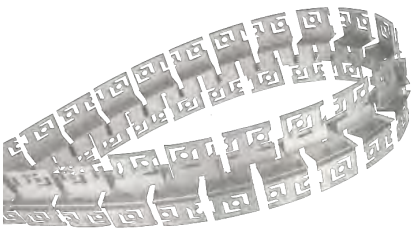
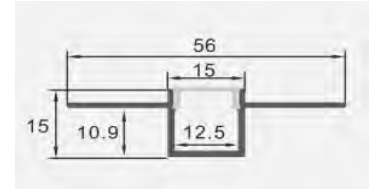

| Referência | Cor | Preço/Mt |
|-------------------|-------------------|------------|
| 777/31 | Alumínio | |
| Dimensão Exterior | Dimensão Interior | |
| 61,4 x 14mm | 12,5mm | |
| Alumínio | Difusor | Superfície |
| 6063-T5 | Silicone | Anodizada |

Difusor flexível: Rolos de 50metros

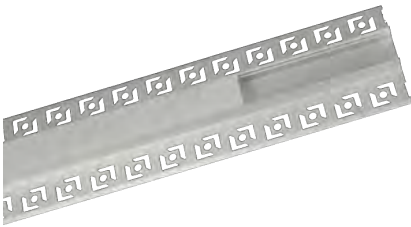

| Referência | Cor | Preço/Mt |
|-------------------|-------------------|------------|
| 777/32 | Alumínio | |
| Dimensão Exterior | Dimensão Interior | |
| 60.22 x 13.64mm | 19.88mm | |
| Alumínio | Difusor | Superfície |
| 6063-T5 | PMMA | Anodizada |

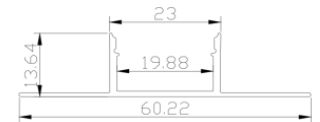

| Referência | Cor | Preço/Mt |
|-------------------|-------------------|---------------|
| 777/33 | Alumínio | |
| Dimensão Exterior | Dimensão Interior | |
| 69 x 69mm | 12,5mm | |
| Alumínio | Difusor | Superfície |
| 6063-T5 | PMMA | Lacado Branco |

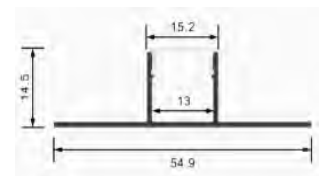

| Referência | Cor | Preço/Mt |
|-------------------|-------------------|------------|
| 777/34 | Alumínio | |
| Dimensão Exterior | Dimensão Interior | |
| 35.35 x 14.7mm | 13mm | |
| Alumínio | Difusor | Superfície |
| 6063-T5 | PMMA | Anodizada |

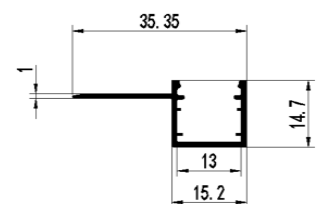



| Referência | Características | Preço |
|------------|--|-------|
| SUSP/PER | Kit de suspensão para perfil de linhas contínuas | |



| Referência | Características |
|------------|---|
| 778 | Topos para perfil Topos para perfil em plástico de encaixe. O topo deve ser escolhido para o respetivo perfil. Todos os topos utilizam a mesma referência. |



| Referência | Características |
|------------|---|
| 778/1 | Fixadores p/perfil Fixadores para perfil em plástico de encaixe. O fixador deve ser escolhido para o respetivo perfil. Todos os fixadores utilizam a mesma referência. |



| Referência | Cor | Preço |
|-------------------|--------------|-------|
| 777/NE1616 | Branco | |
| 777/NE1616P | Preto | |
| Dimensão Exterior | Dimensão PCB | |
| 16 x 16mm | 12mm | |
| Difusor | Material | |
| Branco | Silicone | |
| Preto | | |

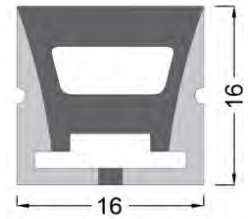

| Referência | Cor | Preço |
|-------------------|--------------|-------|
| 777/NE16CA-B | Branco | |
| Dimensão Exterior | Dimensão PCB | |
| 16 x 16 x 23mm | 12mm | |
| Difusor | Material | |
| Branco | Silicone | |
| Preto | | |

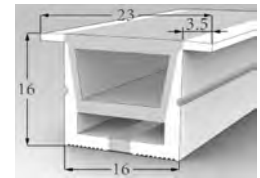

| Referência | Cor | Preço |
|-------------------|--------------|-------|
| 777/NE16CA-P | Preto | |
| Dimensão Exterior | Dimensão PCB | |
| 16 x 16 x 23mm | 12mm | |
| Difusor | Material | |
| Branco | Silicone | |
| Preto | | |

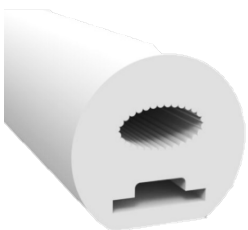

| Referência | Cor | Preço |
|-------------------|--------------|-------|
| 777/NED20 | Branco | |
| Dimensão Exterior | Dimensão PCB | |
| 20mm | 10mm | |
| Difusor | Material | |
| Branco | Silicone | |



Acessórios para Perfil de Neon



| Referência | Características | Cor | Preço |
|------------|---|--------|-------|
| TP-NE1616 | Topos para o Perfil de Neon 777/NE1616 | Branco | |
| TP-NE1616P | Topos para o Perfil de Neon 777/NE1616P | Preto | |
| TP-NED20 | Topos para o Perfil de Neon 777/NED20 | Branco | |
| FP-NE1616 | Fixadores para o Perfil de Neon 777/NE1616 | Branco | |
| FP-NE1616P | Fixadores para o Perfil de Neon 777/NE1616P | Preto | |
| FP-NED20 | Fixadores para o Perfil de Neon 777/NED20 | Branco | |

Perfil c/ fita LED embutida

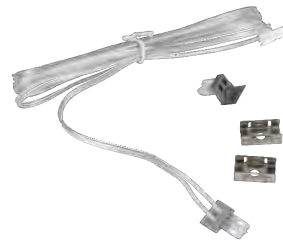

| Referência | Voltagem | Temp. Cor | Cor | Material | Dimensão Interior | Dimensão Exterior | Preço/Mt |
|-------------|----------|-----------|-------|------------------|-------------------|-------------------|----------|
| SR-1010-3 | 24V | 3000K | Preto | Alumínio | 7mm | 10 x 10mm | |
| SR-1313-3 | | | | | | 13 x 13mm | |
| SR-1010-KIT | | | | Fixadores + Topo | | | |
| SR-1313-KIT | | | | Fixadores + Topo | | | |



37

Linear Led



Linear Suspenso

120°
IP
44FP
0,95CRI
>80

| Referência | Potência | Lumens | Temp. Cor | Voltagem | Dimensão | Preço |
|------------|----------|--------|---------------------|------------|---------------------|-------|
| LN356760-4 | 20W | 1800 | 4000K | 200-240VAC | C600 x A35 x L67mm | |
| LN557560-4 | | | | | C600 x A55 x L75mm | |
| LN356712-4 | 40W | 3600 | | | C1200 x A35 x L67mm | |
| LN557512-4 | | | | | C1200 x A55 x L75mm | |
| LN356718-4 | 60W | 5400 | | | C1800 x A35 x L67mm | |
| LN557518-4 | | | | | C1800 x A55 x L75mm | |
| LN356724-4 | 80W | 7200 | C2400 x A35 x L67mm | | | |
| LN557524-4 | | | C2400 x A55 x L75mm | | | |

Linear de Encastrar



| Referência | Potência | Lumens | Temp. Cor | Corte | Dimensão | Preço |
|-------------|----------|--------|-----------|--------------|---------------------|-------|
| LN703560-4E | 20W | 1800 | 4000K | 605x60x60mm | C610 x A35 x L70mm | |
| LN703512-4E | 40W | 3600 | | 1200x60x60mm | C1211 x A35 x L70mm | |
| LN703518-4E | 60W | 5400 | | 1800x60x60mm | C1805 x A35 x L70mm | |
| LN703524-4E | 80W | 7200 | | 2390x60x60mm | C2400 x A35 x L70mm | |

Acessórios para Linear

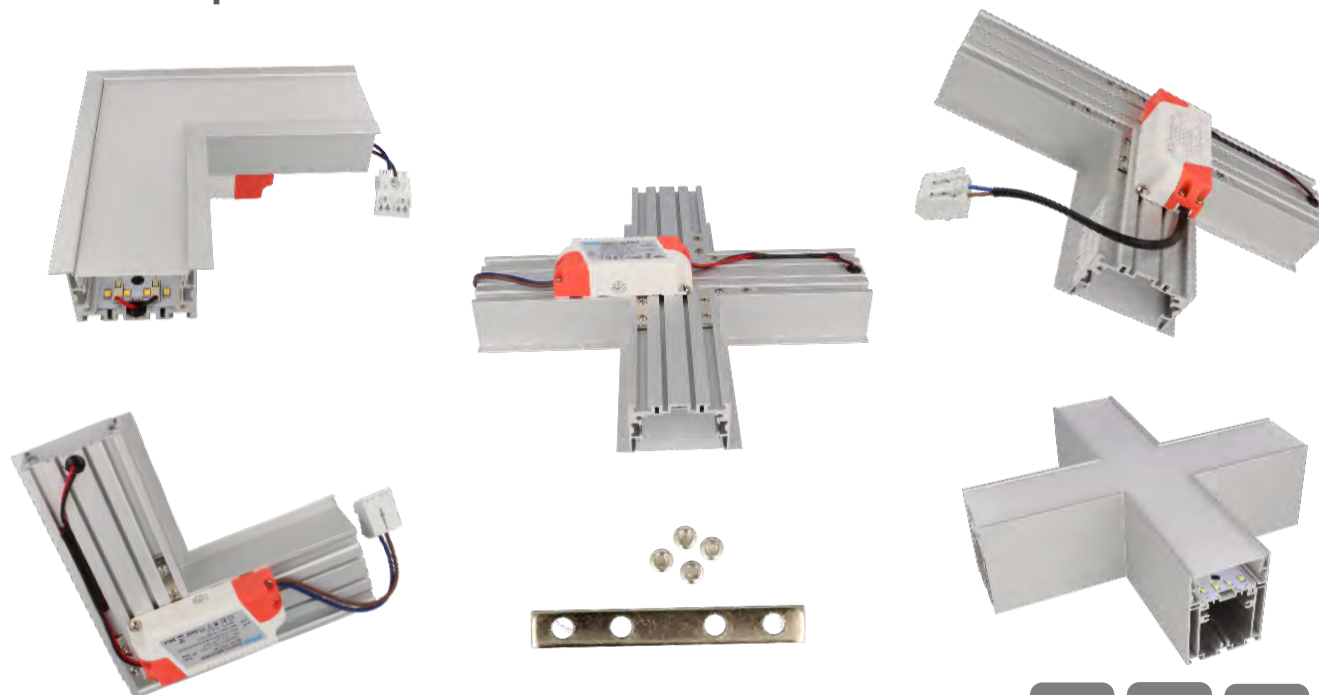

Obs.: Para cada acesorio são necessários conectores de ligação.

120°



IP

44

FP

0,95

CRI

>80

| Referência | Acessório | Características | Cor | Dimensões | Preço |
|------------|---------------|-----------------|-------|-------------------|-------|
| LNT/5575 | Conector em T | Suspensão | 4000K | 100 x 100 x 100mm | |
| LNL/5575 | Conector em L | | | 100 x 100mm | |
| LNx/5575 | Conector em X | | | 100 x 100mm | |
| LNT/7035 | Conector em T | Encastrar | | 100 x 100 x 100mm | |
| LNL/7035 | Conector em L | | | 100 x 100mm | |
| LNx/7035 | Conector em X | | | 100 x 100mm | |
| LN180/3567 | Conexão 180° | | | | |



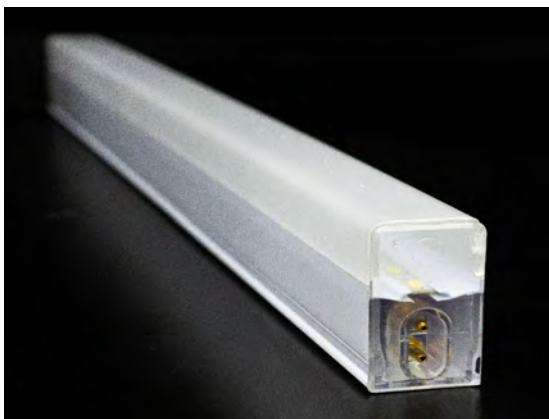

LedTube DIY

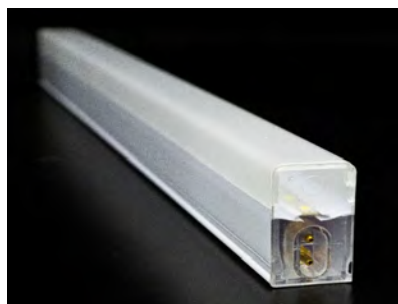
24°
IP
22FP
0,90CRI
>85

| Referência | Cor | Potência | Lumens | Temp. Cor | Voltagem | Dimensão | Preço |
|------------|--------|----------|--------|-----------|------------|--------------|-------|
| TL/44-6 | Branco | 7W | 700 | 6000K | 200-240VAC | 440mm x 20mm | |

Conectores para LedTube DIY



| Referência | Cor | Acessório | Material | Preço |
|------------|--------------|---------------|----------|-------|
| TL/PC | Transparente | Cabo Conector | Plástico | |



| Referência | Cor | Acessório | Material | Preço |
|------------|--------------|---------------|----------|-------|
| TL/CV | Transparente | Conector em V | Plástico | |



| Referência | Cor | Acessório | Material |
|------------|--------------|---------------|----------|
| TL/CY | Transparente | Conector em Y | Plástico |



| Referência | Cor | Acessório | Material |
|------------|--------------|---------------|----------|
| TL/CI | Transparente | Conector em I | Plástico |



| Referência | Cor | Acessório | Material |
|------------|--------------|---------------|----------|
| TL/CT | Transparente | Conector em T | Plástico |



| Referência | Cor | Acessório | Material |
|------------|--------------|---------------|----------|
| TL/CT | Transparente | Conector em L | Plástico |



| Referência | Cor | Acessório | Material |
|------------|--------------|------------|----------|
| TL/NC | Transparente | Braçadeira | Nylon |



| Referência | Cor | Acessório | Material | Preço |
|------------|-----------|------------------|----------|-------|
| TL/SUSP | Cinzentos | Kit de Suspensão | Aço | |



Módulos de LED IP68



| Referência | Potência | Lumens | Temp. Cor | Voltagem | Dimensão | Preço |
|------------|----------|--------|-----------|----------|-----------|-------|
| 615/3 | 1,2W | 115 | 3000K | 12VDC | 79 x 14mm | |



| Referência | Potência | Lumens | Temp. Cor | Voltagem | Dimensão | Preço |
|------------|----------|--------|-----------|----------|-----------|-------|
| 616/4 | 0,72W | 123 | 4000K | 12VDC | 52 x 12mm | |



Obs: Séries de 20 módulos. Comercializado individualmente.

Especificações técnicas

Material: Plástico
 Tempo de vida: 30.000H Led
 Cobertura: Plástico
 Tipo de Led: SMD 5050

| Referência | Potência | Lumens | Temp. Cor | Voltagem | Base | Dimensão | Preço |
|-------------------|----------|------------------------|-----------------------|----------|--------|-----------|-------|
| 615/WN 615/RGB | 2W | 150 R-76; G-23; B-4 | 6000K R G B | 12 VDC | Módulo | 35 x 55mm | |



Obs: Séries de 20 módulos. Comercializado individualmente.

Especificações técnicas

Material: Alumínio
 Tempo de vida: 30.000H Led
 Cobertura: Plástico
 Tipo de Led: SMD 5630

| Referência | Potência | Lumens | Temp. Cor | Voltagem | Base | Dimensão | Preço |
|------------|----------|--------|-----------|----------|--------|-----------|-------|
| 616/WN4 | 2,4W | 220 | 6000K | 12 VDC | Módulo | 35 x 55mm | |



| Referência | Potência | Lumens | Temp. Cor | Voltagem | Dimensão |
|------------|----------|--------|-----------|----------|-----------|
| LM/8016-6 | 1,5W | 210 | 6000K | 12VDC | 80 x 16mm |



| Referência | Potência | Lumens | Temp. Cor | Voltagem | Dimensão |
|-------------|----------|--------|--------------|----------|-----------|
| LM/3636-RGB | 0,72W | 66 | R G B | 12VDC | 36 x 36mm |



| Referência | Potência | Lumens | Temp. Cor | Voltagem | Dimensão |
|------------|----------|--------|-----------|----------|-----------|
| LM/3636-3 | 2W | 240 | 6000K | 12VDC | 36 x 36mm |

40

Diversos LED



Led Diversos



Especificações técnicas

Material: Plástico
 Tempo de vida: 30.000H Led
 Equivalência: 10W Incandescente
 Cobertura: Plástico/Transparente
 Tipo de Led: SMD 3014
 Quant. Leds: 37
 Tipo drive: Interno

360°



IP 40

FP

0,60

CRI

>80

| Referência | Potência | Lumens | Temp. Cor | Voltagem | Base | Dimensão | Preço |
|------------|----------|--------|-----------|-------------|------|------------|-------|
| 198/W | 5W | 460 | 6000K | 85 - 265VAC | E 14 | Ø18 x 65mm | |
| 198/WW | | 410 | 3000K | | | | |



Especificações técnicas

Material: Plástico
 Tempo de vida: 30.000H Led
 Equivalência: 10W Incandescente
 Cobertura: Plástico/Transparente
 Tipo de Led: SMD 2835
 Quant. Leds: 33
 Tipo drive: Interno

360°



IP 40

FP

0,60

CRI

>80

| Referência | Potência | Lumens | Temp. Cor | Voltagem | Base | Dimensão | Preço |
|------------|----------|--------|-----------|-------------|------|------------|-------|
| 098/N830 | 1,5W | 140 | 3000K | 85 - 265VAC | E 14 | Ø23 x 51mm | |
| 098/N840 | | | 4000K | | | | |

GX53



Especificações técnicas

Material: Alumínio
 Tempo de vida: 30.000H Led
 Equivalência: 25W Incandescente
 Cobertura: Plástico/Transparente
 Tipo de Led: SMD 2835
 Quant. Leds: 40
 Tipo drive: Interno

360°



IP 40

FP

0,60

CRI

>80

| Referência | Potência | Lumens | Temp. Cor | Voltagem | Base | Dimensão | Preço |
|------------|----------|--------|-----------|-------------|--------|------------|-------|
| 179+ | 8W | 800 | 6000K | 85 - 265VAC | GX 5.3 | Ø75 x 27mm | |
| 180+ | | 720 | 3000K | | | | |

PL 2G11



Especificações técnicas

Material: Alumínio / Plástico
 Tempo de vida: 30.000H Led
 Base: 2 G11
 Cobertura: Plástico
 Tipo de Led: 2835
 Quant. Leds: 60/76/120/168
 Tipo drive: Interno



| Referência | Potência | Lumens | Temp. Cor | Voltagem | Equivalência | Dimensão | Preço |
|------------|----------|--------|-----------|-------------|--------------|--------------|-------|
| 074/8N | 8W | 850 | 4000K | 85 - 265VAC | ECO 18W | 43mm x 230mm | |
| 074/12N | 12W | 1 020 | | | ECO 25W | 37mm x 320mm | |
| 074/18N | 18W | 1 530 | | | ECO 36W | 37mm x 410mm | |
| 074/22N | 22W | 1 980 | | | ECO 55W | 37mm x 535mm | |

PL 2G10



Especificações técnicas

Material: Alumínio / Plástico
 Tempo de vida: 30.000H Led
 Base: 2 G10
 Cobertura: Plástico
 Tipo de Led: 2835



| Referência | Potência | Lumens | Temp. Cor | Voltagem | Equivalência | Dimensão | Preço |
|------------|----------|--------|-----------|-------------|--------------|------------|-------|
| 2G1012W | 12W | | 2700 | 85 - 265VAC | ECO 25W | 85 x 126mm | |

T8 Circular

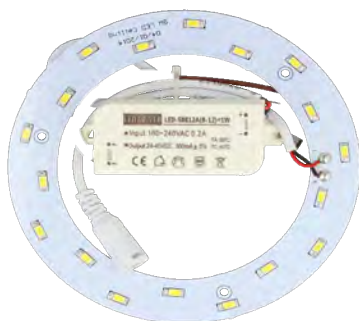

Especificações técnicas

Material: Alumínio
 Tempo de vida: 30.000H Led
 Cobertura: Não
 Tipo de Led: SMD5630
 Quant. Leds: 18/24
 Tipo drive: Externo



| Referência | Potência | Lumens | Temp. Cor | Voltagem | Base | Dimensão | Preço |
|------------|----------|--------|-----------|------------|----------|----------|-------|
| 204/W | 9W | 720 | 6000K | 220-240VAC | Circular | Ø210mm | |

L
O
F
L

CANDEEIRO



2
0
2
6

Candeeiros com Bateria IP54

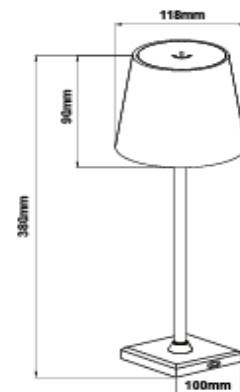

Change the CCT by touch switch

| Referência | Potência | Lumens/Mt. | Cor | Ângulo | Working Time | Material | Dimensão | Preço |
|------------|----------|------------|--------|--------|--------------|------------|-------------|-------|
| T118-B | 3,5W | 270 | Branco | 100° | 10 ~ 15H | Alu + PMMA | 118 x 380mm | |
| T118-P | | | Preto | | | | | |



| Referência | Potência | Lumens/Mt. | Cor | Ângulo | Working Time | Material | Dimensão | Preço |
|------------|----------|------------|--------|--------|--------------|------------|-------------|-------|
| T140-B | 3,5W | 220 | Branco | 100° | 10 ~ 15H | Alu + PMMA | 118 x 380mm | |
| T140-P | | | Preto | | | | | |

Candeeiros Suspensos



| Referência | Potência | Temp. Cor | Composição | Dimensão | Preço |
|------------|----------|-----------|-----------------|-------------|-------|
| PL170856-4 | 44W | 4000K | Fita de Led 24V | 550 x 540mm | |



| Referência | Potência | Temp. Cor | Composição | Dimensão | Preço |
|------------|----------|-----------|-----------------|--------------|-------|
| PL170617-4 | 60W | 4000K | Fita de Led 24V | 1200 x 305mm | |



| Referência | Potência | Temp. Cor | Composição | Dimensão | Preço |
|------------|----------|-----------|-----------------|----------|-------|
| L99141-4 | 18W | 4000K | Fita de Led 24V | | |

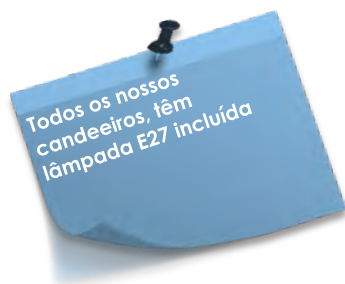

| Referência | Acabamento | Composição | Dimensão | Preço |
|---------------|------------|------------|--------------------|-------|
| PL170803A-E27 | Gold | E27 | 250 x 600 x 1200mm | |



Referência
CTSE27-LD38

Acabamento
Branco

Composição
E27

Dimensão
320 x 160mm

Preço



Referência
CTSE27-LD25

Acabamento
Preto

Composição
E27

Dimensão
300 x 270mm

Preço



Referência
L99859-E27

Acabamento
Preto

Composição
E27

Dimensão
300 x 1200mm

Preço

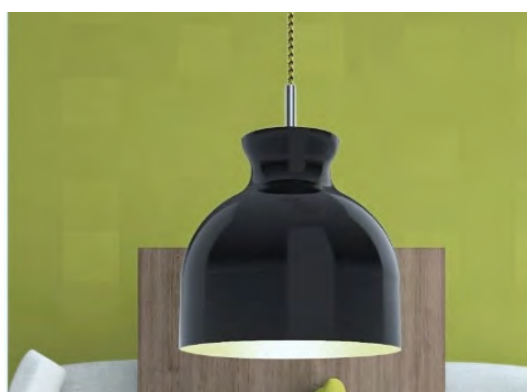

Referência
L998651-E27

Acabamento
Preto

Composição
E27

Dimensão
260 x 1200mm

Preço



| Referência | Acabamento | Composição | Dimensão | Preço |
|---------------|-----------------|------------|-------------|-------|
| CTSE27-LD241A | Cartão Canelado | E27 | 310 x 210mm | |



| Referência | Acabamento | Composição | Dimensão | Preço |
|------------|------------|------------|------------|-------|
| CSPD-D00B | Ferro | E27 | 100 x 25mm | |



| Referência | Acabamento | Composição | Dimensão | Preço |
|------------|------------|------------|------------|-------|
| CSPD-Z2B | Ferro | E27 | 100 x 75mm | |



| Referência | Acabamento | Composição | Dimensão | Preço |
|------------|------------|------------|------------|-------|
| CSPD-12B | Ferro | E27 | 100 x 75mm | |

Candeeiros de Teto



| Referência | Potência | Temp. Cor | Composição | Dimensão | Preço |
|------------|----------|-----------|-----------------|-------------|-------|
| PL99840-4 | 40W | 4000K | Fita de Led 24V | 600 x 170mm | |

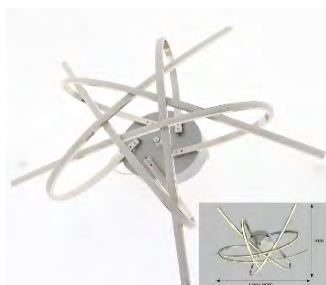

| Referência | Potência | Temp. Cor | Composição | Dimensão | Preço |
|------------|----------|-----------|-----------------|-------------|-------|
| PL170855-4 | 42W | 4000K | Fita de Led 24V | 780 x 185mm | |

Candeeiros de Mesa



| Referência | Potência | Temp. Cor | Composição | Dimensão | Preço |
|------------|----------|-----------|-----------------|-------------|-------|
| TL170239-3 | 33W | 3000K | Fita de Led 24V | 160 x 480mm | |

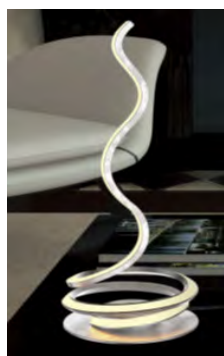

| Referência | Potência | Temp. Cor | Composição | Dimensão | Preço |
|------------|----------|-----------|-----------------|-------------|-------|
| TL170240-4 | 33W | 4000K | Fita de Led 24V | 160 x 435mm | |

Apliques de Teto E27



DT01



DT11



DT12



DT21

| Referência | Cor | Composição | Base | Dimensão | Preço |
|------------|----------------|-------------------------------|------|------------|-------|
| CTE27-DT01 | Antique Bronze | Cabo e casquilho na mesma cor | E27 | 1,5 metros | |
| CTE27-DT11 | Rose | | | | |
| CTE27-DT12 | Bronze | | | | |
| CTE27-DT21 | Gold | | | | |



CORE27BZTX



CORE27BZTW

| Referência | Cor | Composição | Base | Dimensão | Preço |
|------------|------|----------------------|------|------------|-------|
| CORE27BZTX | Gold | Cabo em textil preto | E27 | 1,5 metros | |
| CORE27BZTW | | | | | |



Carregador EV Parede



LCD: 3.5-inch screen
Material: PC+temper Glass
Cable 5M, with TPU protection
Start mode: Plug & play / RFID / App
Communication: Bluetooth / Wifi(optional) App
Protection rank: IP54 IK08

RCD protection: Type B (30mA AC+6mA DC)
Over/Under frequency protection
Electrical Protection
Over current protection
Residual current protection
Surge protection

| Referência | Power | Corrente | Voltagem | IK | IP | Dimensão | Preço |
|------------|-------|--------------|----------|------|----|------------------|-------|
| EVC-WB7K | 7KW | 32A - 1Fase | 230VAC | IK08 | 54 | 265 x 170 x 80mm | |
| EVC-WB22K | 22KW | 32A - 3Fases | 480VAC | | | | |

Carregador EV Portátil



Cabo de carregamento EV portátil 5mt, ICCB, CE, UKCA, RoHS
Cabo de carregamento com protecção em TPU (CE/TUV)
Ecrã LCD 2,8 e indicador LED em RGB
Protecção RCD: 30mA AC
IP55, Weather Proof; Leakage current protection
Ground protection, surge protection, O/U voltage protection
O/U frequency protection, Over temp protection
16A com Ficha BS/Schuko, Ficha azul CEE com 32A
Corpo em termoplástico PC94V-0
Escolha de Amperagem através de Botão



| Referência | Power | Corrente | Voltagem | IP | Dimensão | Preço |
|------------|-------|----------|------------|----|------------------|-------|
| EVC-16AC | 3,5KW | 16A | 200-250VAC | 55 | 235 x 100 x 52mm | |
| EVC-32AC | 7KW | 32A | | | | |

Condições Gerais

1 Informação

- A aquisição de bens à Lord Of Light, Lda implica a aceitação das condições gerais de venda para todos os clientes.
- A Lord Of Light reserva-se ao direito de descontinuar, alterar e/ou substituir os produtos apresentados, assim como, as suas características preços e condições gerais de venda sem aviso prévio.

2 Documentos

- A Lord Of Light, Lda só emite faturas como documento de transporte. Não emitimos Guias de Transporte ou Consignação.
- A Lord Of Light, Lda comercializa todos os seus artigos a pronto pagamento.

Nota: *O não pagamento das faturas nos prazos estipulados importa o vencimento de juros de mora à taxa legal em vigor, bem como a perda dos descontos atribuídos, nos respectivos documentos.*

3 Devoluções

A devolução de um produto comprado há menos de 15 dias poderá ser aceite desde que:

- A mesma seja solicitada junto dos nossos serviços e justificar o motivo da sua devolução.
- Os artigos que se encontrem nas mesmas condições aquando da altura da sua expedição, até 15 dias.
- Os artigos deverão ser acompanhados com um documento onde conste o motivo da devolução e número da fatura de compra.
- O transporte de todas as devoluções é por conta e risco do cliente.
- Artigos que se encontrem em fim de linha/descontinuados não serão aceites para devolução.
- Artigos que, pela quantidade ou especificidade, não façam parte do nosso stock habitual não serão aceites para devolução.
- Não são aceites devoluções de perfil.
- Artigos adquiridos há mais de 15 dias não serão aceites. A não ser com prévia aceitação da gerência.

4 Garantias

- A Lord Of Light, Lda confere 3 anos de garantia em todos os seus artigos, após a data de emissão da fatura.
- Quando o artigo apresentar avaria ou defeito de fabrico durante o período de garantia, a Lord Of Light reserva-se no direito de proceder à sua reparação ou substituição.
- O cliente deverá enviar o artigo com defeito ou avaria para as instalações da Lord Of Light que, posteriormente, fará uma análise técnica e averiguação do mesmo, que ocorrerá num período máximo de 30 dias úteis.
- Para acionar a garantia de um artigo, o cliente deverá apresentar um documento onde conste o número e data da fatura de compra.
- As garantias não cobrem:
 - Uso impróprio ou negligente do artigo que pode causar danos irreversíveis, assim como variações de temperatura, contacto com água, instalações elétricas mal executadas e catástrofes naturais
 - Intervenção nos produtos, nomeadamente tentativas de reparação, manutenção inadequada, ligação a fontes de alimentação impróprias ou alterações nas mesmas, assim como cortes mal executados, que tenham sido efetuados pelo cliente.
 - A alteração de cor do produto com o tempo, devido à oxidação dos acabamentos.
- A Lord Of Light, Lda garante a assistência técnica de todo o material por nós comercializado, além do apoio telefónico.
- A Lord Of Light, Lda não assume custos inerentes a montagem e desmontagem de equipamentos avariados ou com defeito, assim como não é responsável por quaisquer danos diretos ou indiretos que possam resultar de avarias no produto, mesmo elegíveis em garantia.
- Em caso de avarias provocadas pelo uso indevido ou desgaste normal do produto, não serão cobertas pela garantia.

5 Transporte

- As entregas na área metropolitana de Lisboa são fornecidas pela Lord Of Light dentro de um prazo de 24 horas, excepto aquelas de valor mínimo, em que se torna necessário que existam entregas nas proximidades.
- Todas as encomendas em que as faturas não tenham valor superior a 150€ líquidos para ser enviada por transportadora, ficam sujeitas a portes.
- Todas as encomendas com perfil independentemente do valor, acresce o valor dos portes do perfil.
- As encomendas expedidas por transportadora para serem enviadas no próprio dia terão de ser solicitadas até às 16:00.
- Qualquer anomalia encontrada na receção das encomendas deve ser reportada ao motorista e anotada no documento de transporte.
- As mercadorias viajam por conta e risco do cliente.

6 Encomenda de Produtos

- Todas as propostas têm uma validade nelas indicada.
- Em caso de encomendas de artigos que não façam parte do nosso stock habitual ou produtos específicos, o prazo de entrega contará após aceitação da proposta pelo cliente e adjudicação com pagamento de 30% do valor total da proposta, os restantes 70% serão pagos no ato da entrega.
- Os prazos de entrega estabelecidos são apenas previsões e, em caso de força maior, não poderão ser imputadas à Lord Of Light, responsabilidades de atrasos nas entregas dos produtos encomendados, nem o cliente terá o direito de exigir qualquer indemnização.

7 Descontos

- Os descontos comerciais praticados pela Lord Of Light variam consoante o volume de compras dos clientes, podendo ser alterados sem aviso prévio.

8 Litígio

- Em caso de litígio, é única e exclusivamente competente o Tribunal da Comarca de Loures.

9 Observações

- As dimensões indicadas na presente tabela normalmente são fornecidas pelos fabricantes, pelo que carecem sempre confirmação junto dos nossos serviços quando pretenderem instalar qualquer produto.
- As fotos nem sempre correspondem à real imagem, são meramente ilustrativas.
- Aos valores apresentados, acresce a taxa Legal do IVA em vigor.